



PRODUCT OVERVIEW

2023-2024



FOURTH
EDITION



HELLA: AN EXPERT PARTNER TO THE AFTERMARKET AND GARAGES

In the aftermarket the brand name of HELLA stands for a wide and attractive range of products, for professional workshop equipment and for first-class service, all from a single source. These three core competencies together form the HELLA Parts, Tools and Services concept.

IMPORTANT: CATALOG PART NUMBERS

Dear customers,

In this catalog edition you will find "Catalog Part Number" indicated inside a parenthesis in the right side and "HELLA Internal Part Number", text indicated in bold font. The two different part numbers apply for the same product.

Your HELLA Team

CONTENT

1. HELLA GROUP | 4



2. LIGHTING | 6



Auxiliary Lighting | 7
Lighting Modules | 42
Conversion Headlights | 48
Specific Vehicle Lighting | 52
Shapeline Lighting | 54
HELLA VALUEFIT Product Range | 56
Worklights | 78
Optical Warning Systems | 88
HELLA MINING | 102
HELLA MARINE | 103
Bulbs | 104
LED Bulbs | 108
Bulbs Product Range | 112
Halogen Bulbs | 116
Miniature Bulbs | 126
High Intensity Discharge Bulbs | 140
Special Halogen Bulbs | 142
Motorcycle Bulbs | 154

3. WIPER BLADES | 168



HELLA Wiper Blades Range | 168
Standard Wiper Blades | 172
Cleantech 2.0 Wiper Blades | 174
Rear Wiper Blades | 176
Rear wiper blades for Specific Vehicles | 178
Winter Blades | 180
Heavy Duty Wiper Blades | 182
Related Products: Electric Water Pumps,
Cleaning System Headlights, Tanks, Relays | 184

4. ELECTRICS | 186



Acoustic Signal Units | 186
Backup alarms and displays | 202
Relays | 206
Flashers | 216
Electrical Accessories: Bases, Fuse
boxes | 218
Fuses, fuse holders | 220
Cables, sockets and Battery Switch | 223

5. ELECTRONICS | 226



Electronics Product Overview | 226
Highlighted Products | 230
Fuel Pumps | 234

6. HELLA PAGID BRAKE | 236



7. DIGITAL SERVICES | 240



8. TECH INFORMATION | 244



Our catalog gives you an overview and detail of the full range of products. For more details and other applications, please see our websites:

www.myhellalights.com

<https://hella.mypartfinder.com>

HELLA GROUP FACTS



HELLA at a glance

HELLA is listed, internationally positioned automotive supplier operating under the umbrella brand FORVIA. Within this de facto group, HELLA stands for high performance lighting technology and automotive electronics. At the same time, the Company covers a broad service and product portfolio for the spare parts and workshop business as well as for manufacturers of special-purpose vehicles with its Business Group Lifecycle Solutions.

36,000
Employees world wide

40
Best automotive parts
suppliers in the world

125+
Locations world wide

7,000
People working in
research and development





FREEDOM IS WHAT YOU DO!

HELLA auxiliary lamps can cope with all expeditions and adventures, regardless of how rugged the terrain is and the extreme weather.



ADDLIGHT - Discover how your HELLA auxiliary lamps will look in your car, in detail and interactively!
Available in Apple Store and Google Play

www.hella.com/apps

HELLA AUXILIARY LIGHTING

When it comes to accessories, HELLA is always the right partner. For many years, our lighting experience has been reflected in the most varied innovations. With our wide range of auxiliary lamps, reversing lights, work lights, daytime running lights and interior lights, as well as side marker lights and interior lighting, we are one of the leading suppliers in the market. As the use of LED technology increases, HELLA strives to be at the forefront of new ideas and technologies.

More light? Of course! Should we turn night into day for you, or do you want to see the road clearly in front of you, even when the weather is bad? Our auxiliary lights stand out for their legendary performance and quality, and for the spotlights that continue to improve we offer greater safety, lighting your way ideally, whether by fog lights, long, short and wide-range spotlights.



HELLA VALUEFIT: Proven quality at an excellent price



HELLA VALUEFIT is a specific range of auxiliary lighting fixtures, designed exclusively to meet customer requirements. HELLA VALUEFIT products offer reliable quality at a fair price. In addition, HELLA has combined decades of technological knowledge with a unique business experience. As a result, all lighting fixtures meet the relevant technical specifications, are safe, reliable and easy to install.

In addition, there is no need to dispense with important services. HELLA VALUEFIT products offer genuine added value and proven quality at an excellent price!

ELIVER - Online comparison tool for light distribution

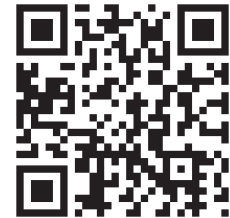

www.hella.com/eliver

Microsite - Meet the HELLA and HELLA VALUEFIT lighting product range



www.myhellalights.com

KNOWLEDGE OF LIGHT AND POWER

Innovations from HELLA. With HELLA, you opt for products with uncompromising quality. We work every day to make our lighting solutions even better and safer. As a result of our relentless innovative energy, we are among the first, best and even the sole suppliers or manufacturers in many areas of vehicle and lighting technology. We are currently pleased to be playing a particularly strong pioneering role with our Rallye LED using 100% LED technology.

Research and development. As in the field of stress testing where we test our products on the durability of the material and light source, HELLA lamps undergo continuous quality and performance tests for light distribution and radiation intensity. They are granted approval under the type approval requirements of the EU approval process. Different tasks require different lamps. The result is lamps of the highest quality – perfectly matched to the most diverse requirements under extreme conditions.

RADIATION INTENSITY



LIGHT DISTRIBUTION SHOULD BE CONSIDERED OBJECTIVELY.

Different applications require different auxiliary lights. The Isolux diagrams show a comparison of light distributions. The red-orange colouring marks the area with high illumination intensity. From yellow through green to blue, the illumination intensity decreases depending on distance. Fog light radiation is wide but not over a long distance (to avoid, as far as possible, reflection through fog droplets).

THE LUX UNIT

As a unit of illuminance, Lux defines the luminous flux from a light source that hits a specified surface. For example, an office should be illuminated with at least 500 Lux and with just 1 Lux the human eye

can read a newspaper without any problem. The values along the Lux bar show where the respective illuminance is achieved in the light distribution diagrams.

THE HIGH-BOOST REFLECTOR

High-boost reflectors are specially developed by HELLA to provide maximum light output. Compared to standard commercial auxiliary lights of similar size, HELLA auxiliary lights with high-boost reflectors deliver a much higher degree of efficiency with improved light output.

THE "REF." REFERENCE NUMBER

The reference number is a value applicable to spotlights. According to the ECE Regulation in effect since 2009, the sum of the reference numbers of all the installed

lamps must not exceed the upper limit of 100 per vehicle. The two values of the standard high beam (left and right main lamps) plus the values of any other extra spotlights are added together. The reference number of HELLA spotlights as well as the E-type approval mark can be found in the catalog for each model. A high beam with a 17.5 reference number emits a wide and full beam, but not as much as a high beam with a 37.5 reference number. A high beam Ref. 37.5 is therefore ideal for long, straight distances, while a high beam Ref. 17.5 can illuminate curved routes (especially mountainous areas) better.

Note: In some countries, a maximum high beam power of only 75 (reference value) may be connected. In those countries, the

high beam integrated into the vehicle must be inoperative when using the Ref. 37.5 high beam; however, the Ref. 17.5 high beam can generally be connected in addition.

CELIS® light guides

With CELIS® technology (Central Lighting Systems), fibreglass cables or thin plastic rods transport the light from a central light source to where it is required.

ECE & SAE APPROVALS

ECE Approval:

The World Forum of Vehicle Regulations is a working party of the United Nations Economic Commission of Europe (ECE). It is tasked with creating a uniform set of regulations for vehicles, which makes them legal on the streets of participating countries.

SAE APPROVAL:

The USA has its own set of standards, which are called the Federal Motor Vehicle Safety Standards (FMVSS), which are based on proposals of the Society of Automotive Engineers (SAE). The USA does not recognize ECE approvals.

Canada has its own Canada Motor Vehicle Safety Standards (CMVSS), broadly similar to FMVSS, but Canada does also accept ECE-compliant headlamps

AUXILIARY LIGHTING

Illumination and Isolux diagrams

Using Isolux diagrams, we can illustrate and compare light distributions. The red-orange colour indicates the area of high intensity illumination; the illuminance falls from yellow to green to blue depending on the distance from the light source.

Rallye 4000 Metal LED with Ref. 40

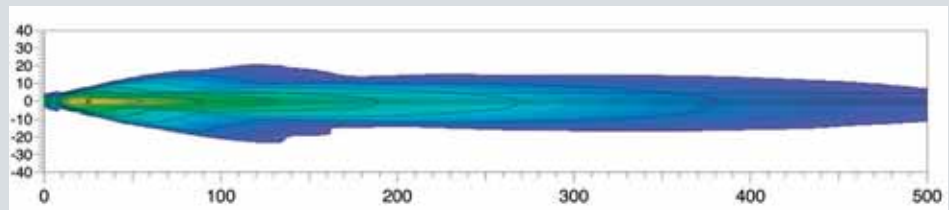

Rallye 40000i Xenon with Ref. 37.5

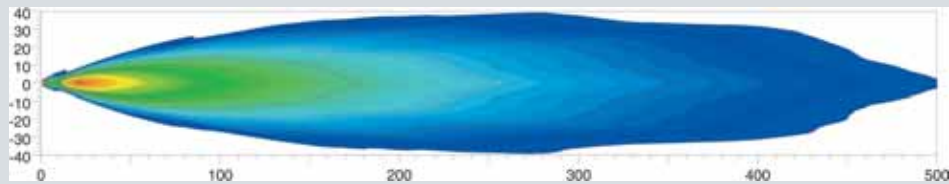

Rallye 4000 Halogen with Ref. 17.5

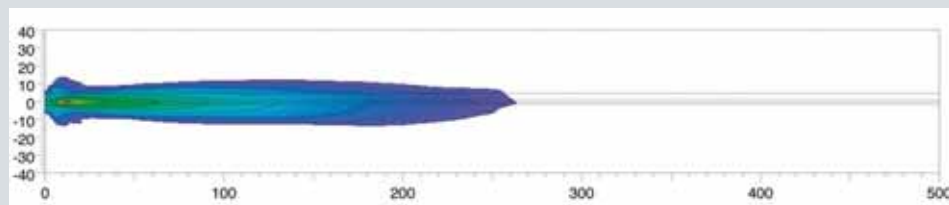

FOG LAMP

Fog lamp HELLA 500 with Ref. 12.5

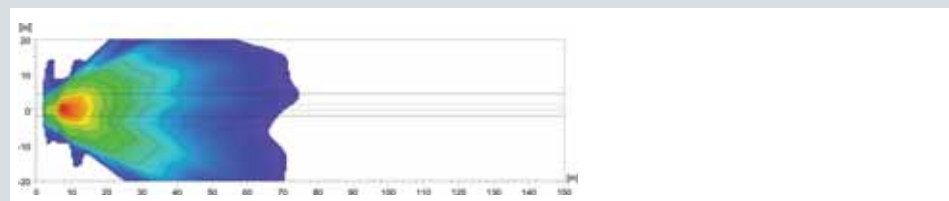



LED LIGHT BAR 470 PO

NEW!

THE AUXILIARY HEADLAMP FOR LONG-DISTANCE VISION WITH THE STRIKING DOUBLE SIGNATURE OF THE POSITION LIGHT.

Whether you are offroad or driving on asphalt surfaces, the LED Light Bar 470 PO opens up new perspectives for you. Developed for the special requirements of offroad vehicles and for aerodynamic installation on truck cab roofs, this high beam headlamp with its position light's striking double-light signature epitomises compact performance in a stylishly confident way. The adventure can begin. Prove that you, too, have got style – and go for the LED Light Bar with the unique position light.

- Multivoltage: 9 - 33 VDC
- Compact high beam LED headlamp
- For off-road use, submersible (fording ability up to a water depth of 1 m for up to 2 hours), IP X9K and IP 6K7
- Effective dissipation of heat created by the LED electronics thanks to the thermo-conductive plastic housing
- Power consumption at 12 V: position light 6 W and high beam 36 W
- Power consumption at 24 V: position light 6 W and high beam 36 W
- ECE approved
- Weight 900g

LED LIGHT BAR 470 PO

Content:

- Individual headlamp with 2,500 mm, 3-pin connecting cable (with open ends)
- Including bracket set
- Integral LED light sources

Description	Part Number:
LED high beam headlamp	958140001



Driving Beam



RALLYE 4000 LED METAL

NEW!

THE NEW AUXILIARY HEADLAMP WITH AN UNMISTAKABLE DESIGN.

- Auxiliary driving lamp with futuristic look boasting state-of-the-art LED technology
- The striking night design is created by the LED position light with its characteristic hexagonal contoured design
- EdgeLight technology has been applied for a more intensive appearance of the position light
- The horizontal cooling fin in the auxiliary headlamp with a cooling surface of 230 cm² brings about efficient thermal management
- Replaceable LED headlamp insert with shock-resistant and fixing bracket of zinc die casting

- Voltage: 12/24 VDC
- Light output (measured): 1300 lumens (driving beam), 1220 lumens (pencil beam)
- Light beam pattern: pencil, driving
- Power consumption: @ 12V: 2.4 W + high beam @ 24 V: 5 W + high beam
- Color temperature: 6500 Kelvin
- Housing material: Aluminum
- Lens material: PC
- Mounting: zinc die-cast
- Mounting type: horizontal
- Connection: lead wires
- Approval: high beam ECE R112, ECE R7 parking light, ECE R10 EMC

Content:

- LED high-beam headlamp with LED position light
- With connecting cable
- Mounted fixing bracket
- Mounting instructions

Description	Part Number	Spare Parts	Part Number
Driving beam	016560101	Headlamp insert, Driving Beam	241430011
Pencil Beam	016560111	Headlamp insert, Pencil Beam	241449011



Driving Beam

*Can be used to upgrade Rallye 4000 halogen headlight

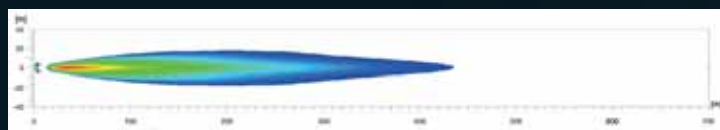

Pencil Beam

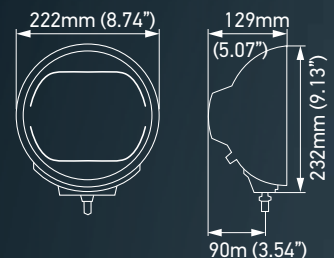
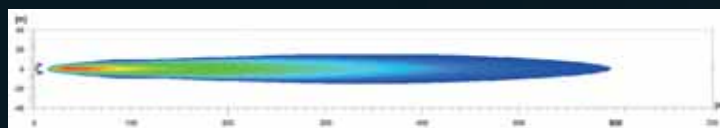

RALLYE 3003 LED

NEW!

STRIKING DESIGN, POWERFUL LIGHT OUTPUT

- Auxiliary driving lamp with futuristic look boasting state-of-the-art LED technology
- The striking night design is created by the LED position light with its characteristic hexagonal contoured design
- Immediate response thanks to attention-grabbing headlight flashing
- EdgeLight technology has been applied for a more intensive appearance of the position light
- The horizontal cooling fin in the auxiliary headlamp with a cooling surface of 230 cm² brings about efficient thermal management
- Replaceable LED headlamp insert with shock-resistant PC cover lens
- Protection classes: IP X9K, IP 6K7

- Voltage: 12 VDC / 24 VDC
- Light pattern: Driving beam and Pencil Beam
- Power Consumption: 14.5 Watt + 5 Watt PO light
- Color temperature: 6500 Kelvin
- Housing material: Thermoplastic
- Lens material: PC cover lens
- Mounting Type: Vertical
- Approval: ECE

Content:

- 1 LED headlamp with LED position light
- With connecting cable
- Mounting instructions and installation components



Description	Part Number:
Driving Beam	016797001
Pencil Beam	016797011

Replacement parts:

- Headlamp insert for Driving Beam **241400011**
- Headlamp insert for (Pencil Beam) **241429011**

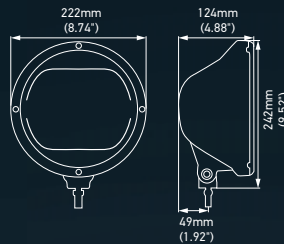

Driving Beam

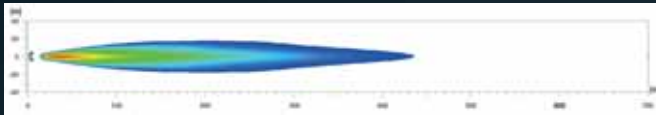

Pencil Beam

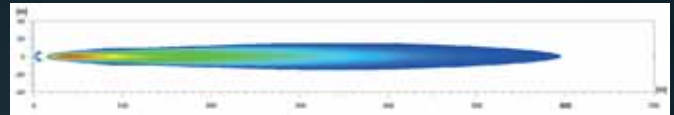

JUMBO LED

NEW!

THE NEW AUXILIARY HEADLAMP WITH THE BRILLIANT, SEISMIC SMILE.

Just the name says it all: the new Jumbo LED is a full LED headlamp with a special kind of radiance – delivering luminous efficiency even more unconditionally and absolutely than its legendary predecessor. Let's see you smile – just convert now to the new Jumbo LED.

The Edge light technology intensifies the characteristic contours of the highly recognizable LED position light.

Content:

- LED high beam headlamp with LED position light
- With 3-pin connecting cable 800 mm (with open ends)
- Attachment material
- Installation instructions

- Multi-voltage: suitable for 12 V and 24 V
- Clear and bright white LED light
- Long-lasting light emission
- Impact-resistant housing made of high-quality thermoplastic material
- Immediate response for attention-grabbing headlight flashing
- Sturdy fastening bracket made of zinc-coated sheet steel with wide adjustment range
- Electronics components qualified according to automotive standard
- Particularly energy efficient and fuel saving
- Power consumption at 12 V: PO light 1.3 W and high beam 8 W
- Power consumption at 24 V: PO light 2.7 W and high beam 8 W
- ECE type-approved (ECE R149 high beam, ECE R148 position light, ECE R10 EMC)
- Weight 980g



Description	Part Number
LED headlamp , upright	016773001

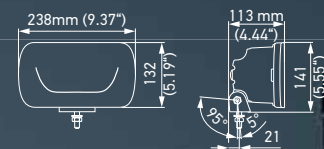
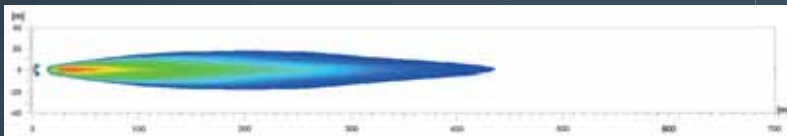



HELLA BLACK MAGIC LED

NOW WITH THE ALL NEW
BLACK MAGIC TOUGH LIGHTBARS



HELLA BLACK MAGIC LED PRODUCT RANGE

AUXILIARY LIGHTS

LED

CUBES	MINI LIGHTBARS	LIGHTBARS	TOUGH SLIM LIGHTBARS	NEW!	TOUGH SLIM CURVED LIGHTBARS	NEW!
CUBES KIT	SINGLE	SINGLE	SINGLE		SINGLE	
2.7" Flood 358176801  3.2" Flood 358176811  3.2" Spot 358176821  3.2" Spot /Flush 358176831 	6.2" Flood 358176201  6.2" Spot 358176211  6.2" Flush Mount, Flood 358176221 	20" Slim 358176301  32" Slim 358176311  40" Slim 358176321  50" Slim 358176331  21.5" Double 358176401 	20" Tough Slim 358197301  32" Tough Slim 358197311  40" Tough Slim 358197321  50" Tough Slim 358197331 	NEW!	20" Slim Curved 358197501  32" Slim Curved 358197511  40" Slim Curved 358197521  50" Slim Curved 358197531 	NEW!
ACCESSORIES				NEW!		NEW!
 Bracket set for light bar variant "Slim Row" 358176371						
 Bracket set for light bar variant "Double Row" 358176381						
			SINGLE		SINGLE	
			21.5" Tough Double 358197401 		21.5" Tough Double Curved 358197601 	
			32" Tough Double 358197411 		32" Tough Double Curved 358197611 	
			40" Tough Double 358197421 		40" Tough Double Curved 358197621 	
			50" Tough Double 358197431 		50" Tough Double Curved 358197631 	
			52" Tough Double 358197441 		52" Tough Double Curved 358197641 	

BLACK MAGIC LED SERIES

FLEXIBLE INSTALLATION

The installation kit comes complete with a lengthy cable to allow for easy vehicle mounting. The Mini Lightbar, Cubes and Lightbars come as a Flood or Spotlight and can be pendant mounted, upright or integrated into the body work or bumper. This light bar is ready to brighten up your big next adventure.



See on page 19

See on page 16

See on page 19

See on page 16

See on page 20

LED

BLACK MAGIC LED SERIES

THE NEW FULL BLACKOUT APPEARANCE

SPECIFICATIONS

- Offers some of the toughest dust / water protection on the market
- Full blackout appearance including mounting hardware
- Sleek design
- Specially developed reflector design for homogeneous illumination

For further information on each product, see general overview on page 8-19

BLACK MAGIC LED DISPLAY

Counter displays are the best way to promote and demonstrate the products to your customers. Mounted on a solid metal base, the display is equipped with switches and a converter to demonstrate the tremendous light performance of these new auxiliary lights. Consult with our sales representative for more information.



999942841



Online product
information

360°
BLACK



BLACK MAGIC TOUGH

DARK BEAUTY

NEW!

Everything appears in the right light, thanks to a sophisticated reflector design and a power LED.

Beauty that comes from within and radiates outwards: the **HELLA Black Magic Light Bars** are available in 18 different variants for off-road use. With up to 80 LEDs, an effective light output of up to 20,000 lumens is easily achieved. This leaves absolutely nothing in the dark – and the adventure can begin.

The light bars are available in many different lengths as "Slim" and as a "Double Row" – and for the first time both types are now also available as curved variants. All models are equipped with a temperature control system: it adjusts the light bars to the ambient temperature, protecting against overheating and also regulating the light output in cold ambient temperatures – ideal for off-road use, no matter on which continent you happen to be driving.

**Absolute freedom that you can feel – and see.
Off the road!**

No rules, no regulations: fix whatever you like on your vehicle! On the roof, on the roof bar, on the radiator grille or on the bumper, in pairs or singly – you decide what your vehicle needs for its next mission. You can be completely flexible in the choice of your light bars and their combination. And by the way: you'll be giving your pick-up or off-roader a really cool look: the all-black, heavy-duty design bestows upon your vehicle a unique character down to the very last detail – making it extravagant, robust and unconventional.

GO YOUR OWN WAY. EVEN WHEN YOU'RE OFF THE BEATEN TRACK.



Optimal hold. And all that in grand style.

Mounted just the once, and never moves – with the right bracket. The scope of delivery for **HELLA Black Magic Light Bars** for offroad use includes side brackets for screw mounting. For light bars longer than 40 inches, HELLA recommends the secure four-point mounting system with additional brackets.

The accessory sets for "Slim Row" and for "Double Row" each consist of two brackets and two sets of screws – and can be quickly mounted. Simply insert them into the headlamp's guide rail, and tighten the screws securely! Switch on and then it's a case of hello light, goodbye boring routine!





IN TOP SHAPE. IN 18 VARIATIONS.

NEW!

Black Magic 20" Slim Light Bar

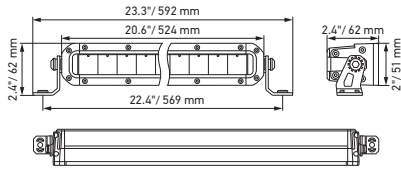

Black Magic 32" Slim Light Bar

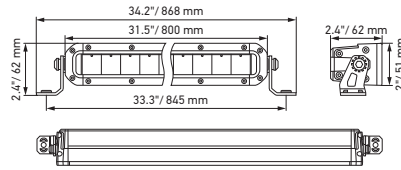

Black Magic 40" Slim Light Bar

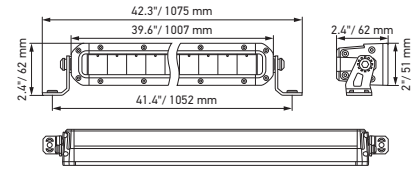

Black Magic 50" Slim Light Bar

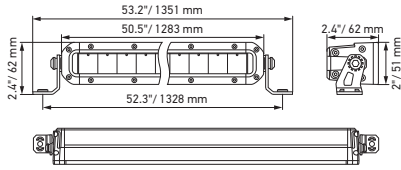

Black Magic 21.5" Double Row Light Bar

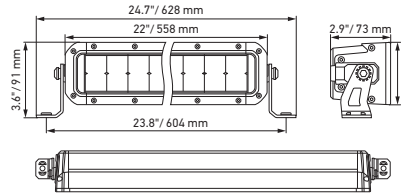

Black Magic 30" Double Row Light Bar

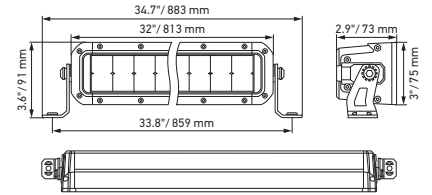

Black Magic 40" Double Row Light Bar

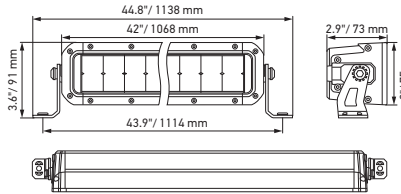

Black Magic 50" Double Row Light Bar

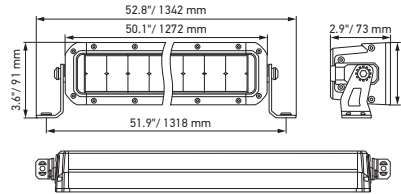

Black Magic 52" Double Row Light Bar

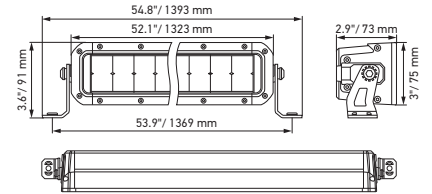

A

Black Magic 20" Slim Curved Light Bar

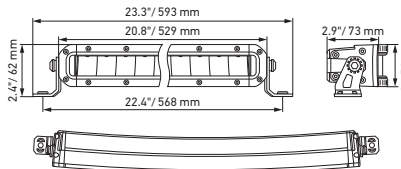

Black Magic 32" Slim Curved Light Bar

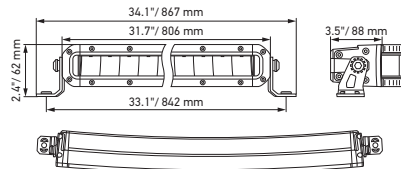

Black Magic 40" Slim Curved Light Bar

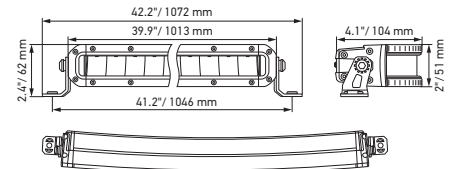

Black Magic 50" Slim Curved Light Bar

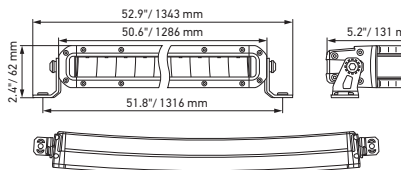

Black Magic 21.5" Double Row Curved Light Bar

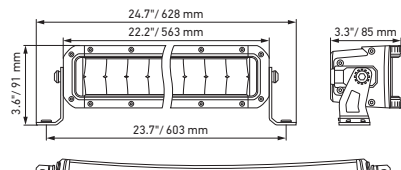

Black Magic 30" Double Row Curved Light Bar

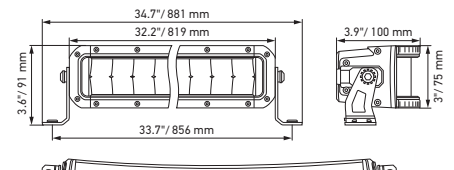

Black Magic 40" Double Row Curved Light Bar

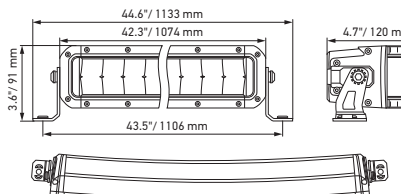

Black Magic 50" Double Row Curved Light Bar

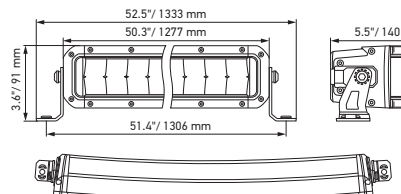

B

Black Magic 52" Double Row Curved Light Bar

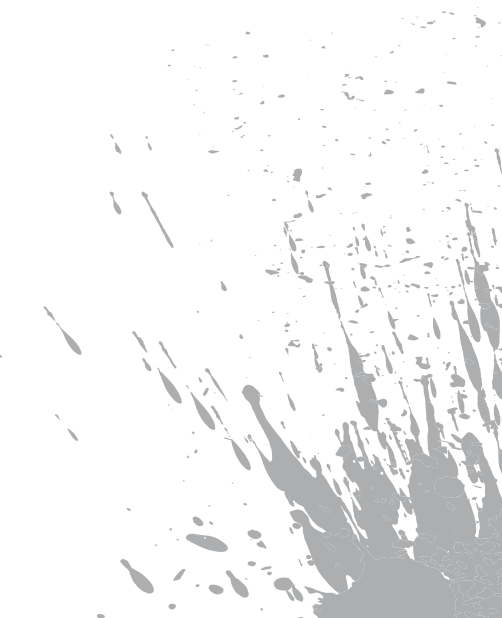
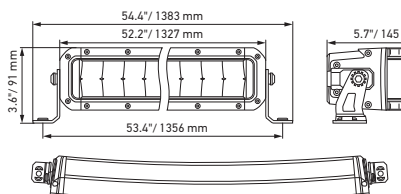

LIGHTS ON. GO GRAVEL TRACK. GO FOREST. GO MOUNTAIN. GO LAKE. GO FIELD PATH. GO GRASSLAND. GO ADVENTURE.

Crash through barriers, because anything is possible. No matter what the surface, no matter what kind of dirt track, with the 18 different light bars for off-road driving, you can equip your vehicle for any kind of demand. And at the same time you are spoiled for choice because the possible combinations are almost unlimited. The off-road light bars can also be combined with the ECE variants: choose the light bars you need – and every path will light up.

The right light for every road or path.
Even when there is no road or path there!



Black Magic 52" Double Row Light Bar
358197441

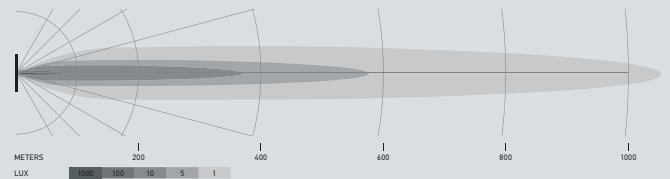

Black Magic 50" Double Row Curved Light Bar
358197631

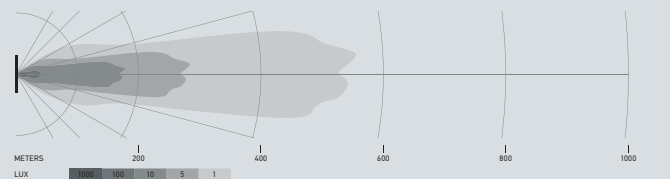



TECHNICAL DETAILS

NEW!

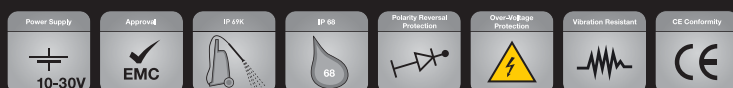
Technical Data	
Rated voltage	Multi-voltage
Operating voltage	10–30 V
Light function	High beam or combi beam (curved)
Light source	LED
Colour temperature	5,700 kelvin
Material	Aluminium, black stainless steel bracket
Degree of protection	IP 68, IP 69K
EMC protection	ECE-R10
Mounting	Upright / pendant
Connection	2 m cable with open ends
Mounting type	Screw attachment
Application	For all manner of off-road vehicles including pick-ups, trucks, buggies, quads













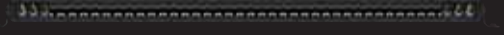
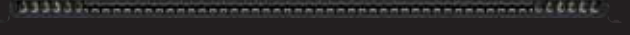

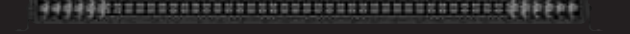
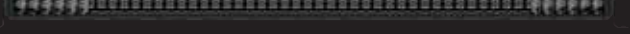

ACCESSORIES

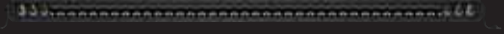
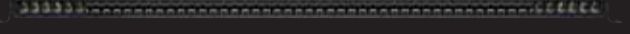
Product Image	Description	Part Number
	The bracket set for rear mounting is recommended as a mounting accessory for additional support of the LED light bars in the following lengths: 40", 50" and 52". The set includes two brackets and two sets of screws. The brackets are inserted into the headlamp's guide rail and securely fastened in the required position using the screws.	
	Bracket set for light bar variant "Slim Row"	358176371
	Bracket set for light bar variant "Double Row"	358176381

PROGRAM OVERVIEW

NEW!

Product Image	Description	Part Number	PU*
Black Magic Slim Light Bar			
	20" Slim Lightbar, TSS	358197301	1
	32" Slim Lightbar, TSS	358197311	1
	40" Slim Lightbar, TSS	358197321**	1
	50" Slim Lightbar, TSS	358197331**	1
Black Magic Double Row Light Bar			
	21,5" Double Row Lightbar, TSD	358197401	1
	30" Double Row Lightbar, TSD	358197411	1
	40" Double Row Lightbar, TSD	358197421**	1
	50" Double Row Lightbar, TSD	358197431**	1
	52" Double Row Lightbar, TSD	358197441**	1 A
Black Magic Slim Curved Light Bar			
	20" Slim Curved Lightbar, TCS	358197501	1
	32" Slim Curved Lightbar, TCS	358197511	1
	40" Slim Curved Lightbar, TCS	358197521**	1
	50" Slim Curved Lightbar, TCS	358197531**	1
Black Magic Double Row Curved Light Bar			
	21,5" Double Row Curved Lightbar, TCD	358197601	1
	30" Double Row Curved Lightbar, TCD	358197611	1
	40" Double Row Curved Lightbar, TCD	358197621**	1
	50" Double Row Curved Lightbar, TCD	358197631**	1 B
	52" Double Row Curved Lightbar, TCD	358197641**	1

* Packaging unit

** For sturdy four-point mounting of the light bar from 40" upwards, we recommend the accessory bracket set found on page 10.









BLACK MAGIC LED SERIES

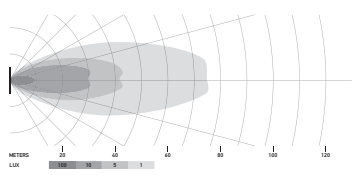

BLACK MAGIC LED - CUBES

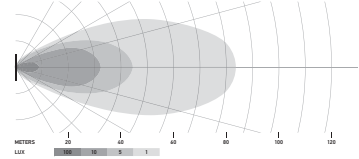
- Full blackout appearance including black brackets
- Sleek design eliminates dust and dirt from being lodged in edges
- Each kit includes the wiring harness with DT connector, switch, connector and relays (easy to install)
- Compact design for universal installation

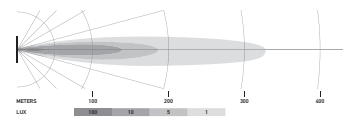

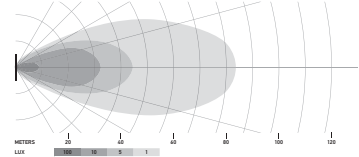
Product image / Dimensions	Light Distribution	Technical Specifications	Part Number
<p>LED CUBE KIT 2.7" SHORT RANGE</p> 	<p>LED</p> 	<ul style="list-style-type: none"> • Voltage: 10-30 VDC • Light output (measured): 1080 lumens • Beam Pattern: Driving • Power consumption: 20 Watt • Color temperature: 5700 Kelvin • Housing material: Aluminum, black stainless steel bracket • Lens material: PC • Mounting type: horizontal • Connection: lead wires • Approval: ECE-R10 • Protection: IP68, IP69K 	<p>358176801 Driving Beam</p> <p>Content: Includes: (2) LED Headlights, (1) Relay, (1) switch and mounting instructions, (1) wire harness with DT connector</p>
<p>LED CUBE KIT 3.2" SHORT RANGE</p> 	<p>LED</p> 	<ul style="list-style-type: none"> • Voltage: 10-30 VDC • Light output (measured): 2600 lumens • Beam Pattern: Driving • Power consumption: 40 Watt • Color temperature: 5700 Kelvin • Housing material: Aluminum, black stainless steel • Lens material: PC • Mounting type: horizontal • Connection: lead wires • Approval: ECE-R10 • Protection: IP68, IP69K 	<p>358176811 Driving Beam</p> <p>Content: Includes: (2) LED Headlights, (1) Relay, (1) switch and mounting instructions, (1) wire harness with DT connector</p>
<p>LED CUBE KIT 3.2" LONG RANGE</p> 	<p>LED</p> 	<ul style="list-style-type: none"> • Voltage: 10-30 VDC • Light output (measured): 2600 lumens • Light beam pattern: Long range • Power consumption: 40 Watt • Color temperature: 5700 Kelvin • Housing material: Aluminum, steel bracket black stainless • Lens material: PC • Mounting type: horizontal • Connection: lead wires • Approval: ECE-R10 • Protection: IP68, IP69K 	<p>358176821 Long range</p> <p>Content: Includes: (2) LED Headlights, (1) Relay, (1) switch and mounting instructions, (1) wire harness with DT connector</p>
<p>LED CUBE KIT 3.2" SHORT RANGE / FLUSH</p> 	<p>LED</p> 	<ul style="list-style-type: none"> • Voltage: 10-30 VDC • Light output (measured): 2600 lumens • Beam Pattern: Driving • Power consumption: 40 Watt • Color temperature: 5700 Kelvin • Housing material: Aluminum, steel bracket black stainless • Lens material: PC • Mounting type: horizontal • Connection: lead wires • Approval: ECE-R10 • Protection: IP68, IP69K 	<p>358176831 Driving Beam</p> <p>Content: Includes: (2) LED Headlights, (1) Relay, (1) switch and mounting instructions, (1) wire harness with DT connector</p>



BLACK MAGIC LED - LIGHT BARS

- Full blackout appearance including black brackets
- Sleek design
- Temperature Control System
- Intense light output



Product image / Dimensions	Light Distribution	Technical Specifications	Part Number
LED LIGHT BAR 20" 		<ul style="list-style-type: none"> • Voltage: 10-30 VDC • Light output (measured): 6000 lumens • Beam Pattern: Driving • Power consumption: 60 Watt • Color temperature: 5700 Kelvin • Housing material: Aluminum, black stainless steel bracket • Lens material: PC • Mounting type: horizontal • Connection: lead wires • Approval: ECE-R10 • Protection: IP68, IP69K 	358176301 Long range Content: (1) Light bar LED (1) assembly instructions, (1) wiring harness
LED LIGHT BAR 32" 		<ul style="list-style-type: none"> • Voltage: 10-30 VDC • Light output (measured): 9000 lumens • Beam Pattern: Driving • Power consumption: 100 Watt • Color temperature: 5700 Kelvin • Housing material: Aluminum, black stainless steel bracket • Lens material: PC • Mounting type: horizontal • Connection: lead wires • Approval: ECE-R10 • Protection: IP68, IP69K 	358176311 Long range Content: (1) Light bar LED (1) assembly instructions, (1) wiring harness
LED LIGHT BAR 40" 		<ul style="list-style-type: none"> • Voltage: 10-30 VDC • Light output (measured): 12,000 lumens • Beam Pattern: Driving • Power consumption: 125 Watt • Color temperature: 5700 Kelvin • Housing material: Aluminum, black stainless steel bracket • Lens material: PC • Mounting type: horizontal • Connection: lead wires • Approval: ECE-R10 • Protection: IP68, IP69K 	358176321 Long range Content: (1) Light bar LED, (1) assembly instructions, (1) wiring harness
LED LIGHT BAR 50" 		<ul style="list-style-type: none"> • Voltage: 10-30 VDC • Light output (measured): 15,000 lumens • Beam Pattern: Driving • Power consumption: 160 Watt • Color temperature: 5700 Kelvin • Housing material: Aluminum, black stainless steel bracket • Lens material: PC • Mounting type: horizontal • Connection: lead wires • Approval: ECE-R10 • Protection: IP68, IP69K 	358176331 Long range Content: (1) Light bar LED (1) assembly instructions, (1) wiring harness
LED DOUBLE LIGHT BAR 21.5" 		<ul style="list-style-type: none"> • Voltage: 10-30 VDC • Light output (measured): 15,000 lumens • Beam Pattern: Driving • Power consumption: 160 Watt • Color temperature: 5700 Kelvin • Housing material: Aluminum, black stainless steel bracket • Lens material: PC • Mounting type: horizontal • Connection: lead wires • Approval: ECE-R10 • Protection: IP68, IP69K 	358176401 Long range Content: (1) Light bar LED, (1) assembly instructions, (1) wiring harness

BLACK MAGIC LED - MINI LIGHT BARS

- Offers some of the toughest dust / water protection on the market
- Full blackout appearance including mounting hardware
- Sleek design



Product image / Dimensions	Light Distribution	Technical Specifications	Part Number
----------------------------	--------------------	--------------------------	-------------

LED MINI LIGHT BAR 6.2" SHORT RANGE

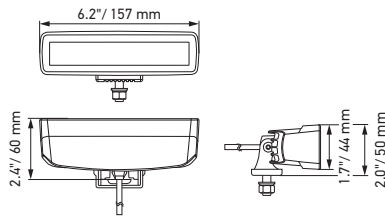
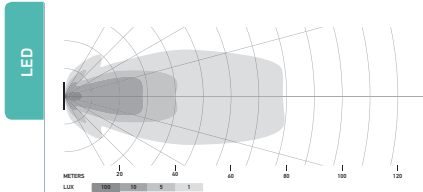

- Voltage: 10-30 VDC
- Light output (measured): 1600 lumens
- Beam Pattern: Driving
- Power consumption: 30 Watt
- Color temperature: 5700 Kelvin
- Housing material: Aluminum, black stainless steel bracket
- Lens material: PC
- Mounting type: horizontal
- Connection: lead wires
- Approval: ECE-R10
- Protection: IP68, IP69K

358176201 Short range

Content:
 (1) Light bar LED,
 (1) assembly instructions,
 (1) wiring harness

LED MINI LIGHT BAR 6.2" LONG RANGE

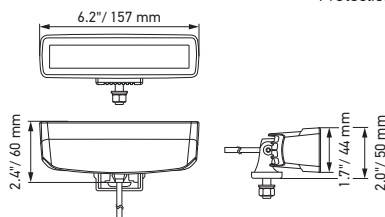
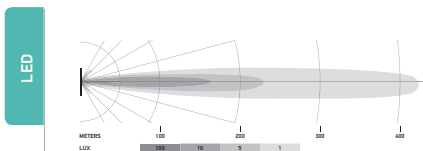

- Voltage: 10-30 VDC
- Light output (measured): 1600 lumens
- Beam Pattern: Driving
- Power consumption: 30 Watt
- Color temperature: 5700 Kelvin
- Housing material: Aluminum, black stainless steel bracket
- Lens material: PC
- Mounting type: horizontal
- Connection: lead wires
- Approval: ECE-R10
- Protection: IP68, IP69K

358176211 Long range

Content:
 (1) Light bar LED,
 (1) assembly instructions,
 (1) wiring harness

LED MINI LIGHT BAR 6.2" FLUSH

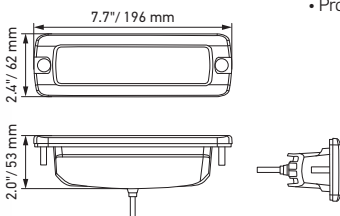
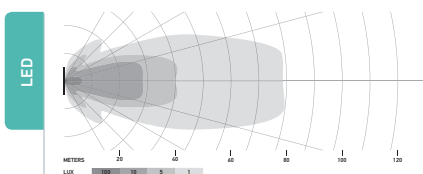

- Voltage: 10-30 VDC
- Light output (measured): 1600 lumens
- Beam Pattern: Driving
- Power consumption: 30 Watt
- Color temperature: 5700 Kelvin
- Housing material: Aluminum, black stainless steel bracket
- Lens material: PC
- Mounting type: horizontal
- Connection: lead wires
- Approval: ECE-R10
- Protection: IP68, IP69K

358176221 Short range

Content:
 (1) Light bar LED,
 (1) assembly instructions,
 (1) wiring harness



999942841

HELLA BLACK MAGIC LED DISPLAY

Counter displays are the best way to promote and display products to your customers. Mounted on a solid metal base, the display is equipped with switches and a power converter to demonstrate the tremendous light output of these new auxiliary lights. Check with our sales representative for more information.



HELLA LED LIGHT BAR SERIES



The Choice of the Professional Driver

Then look no further: HELLA has just the right equipment for professional and recreational drivers, introducing a range of award winning LED light bars that guarantee powerful illumination for ultra-durable applications: Meet the LED Light Bar 350 and its bigger brother, the LED Light Bar 470.

As a manufacturer of world leading state of the art light technology, HELLA's relentless dedication to continuously improve the latest designs is shown in the unique range of LED Light Bars that stand out due to their light weight, a revolutionary non corrosive housing and a flexible mounting system for numerous applications.



LED Light Bar 350
SEMA Global Media Awards Winner 2016



LED Light Bar 470

01 Outstanding Thermal Performance

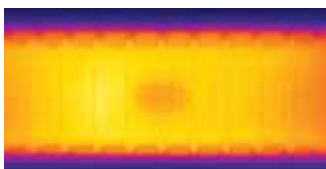

Revolutionary plastic ceramic materials, with outstanding thermal performance, open up a world of possibilities that was never thought to be achievable only a few years ago. The replacement of metal based housing heat-sinks with thermally conductive plastic not only opens a myriad of design options, but also means complete corrosion resistance. This is especially important in demanding environmental conditions where lights are constantly exposed to the elements and are sometimes temporarily submerged.

A lamp housing made from thermally conductive plastic works much the same as the previously used metal housing. The innovative ceramic based plastic transfers the heat generated by the LED's and drive electronics to the outside of the lamp body, thereby lowering the internal thermal stress on the component. This in turn ensures a long service life with minimal degradation of the LED's.

02 Intelligent Design Features

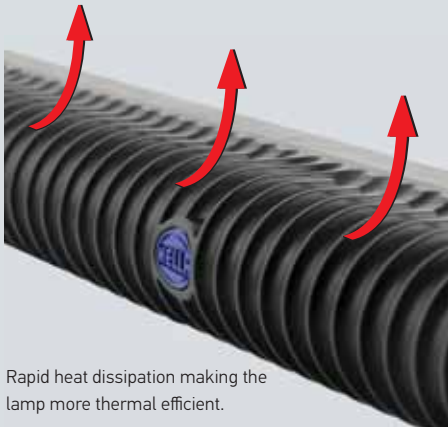

Rapid heat dissipation making the lamp more thermal efficient.

Expertly designed and precision manufactured for the toughest of outdoor conditions.

The LED Light Bar housing has been purposely designed with a wavy contour to optimize rapid heat dissipation, making the lamp more thermal efficient.

Off-roading can be a dirty business, the wavy contour is easy to clean as there are no cavities which can be clogged with dirt, unlike traditional light bars with a horizontal fin design.



Housing design incorporates an easy to clean profile.

03 Light Weight

Less metal also means less weight: Lamps with thermally conductive plastic are up to 60% lighter than comparable metal bodied lamps. The much lower mass significantly reduces the stress on mounting points in high vibration and shock applications.

When mounting the popular Driving Lights on ATV's and off-road vehicles, weight is an important factor. Compared to many heavier lights in the market, HELLA's Light Bars have little impact on the original vehicles all-important weight distribution.

Double bracket light bar for off-road use only



04 LEDs

Durable high performance automotive grade LEDs and precision optics give the light bar superior illumination on and off-road.



LED Light Bar 350 - 12 LEDs
LED Light Bar 470 - 16 LEDs



05 Dust and Waterproof

Built to stand all weather and off-road conditions the light bar is hermetically sealed making it dust and waterproof.

IP 6K7 (Protection against dust and temporary water immersion)

IP 6K9K (Protection against dust and highpressure/steam jet cleaning)

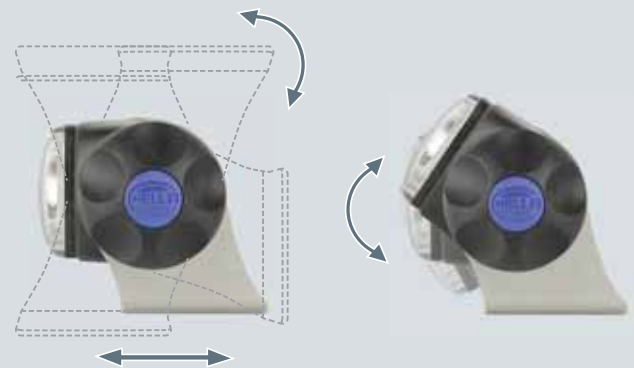

06 Low Profile Mounting System

The HELLA LED Light Bar has a much lower profile than traditional light bars, this allows more flexibility in where the lamp can be mounted. The aerodynamic design results in less disturbance to the air flow so that the vehicle's cooling and performance are not adversely affected if the lamp is mounted near a radiator grille.

The heavy duty bracket will suit most vehicle installations. Easy to mount and adjust and therefore ideal for numerous applications. Made of stainless steel, it is ultra durable and non corrosive.



HELLA LED LIGHT BAR 470

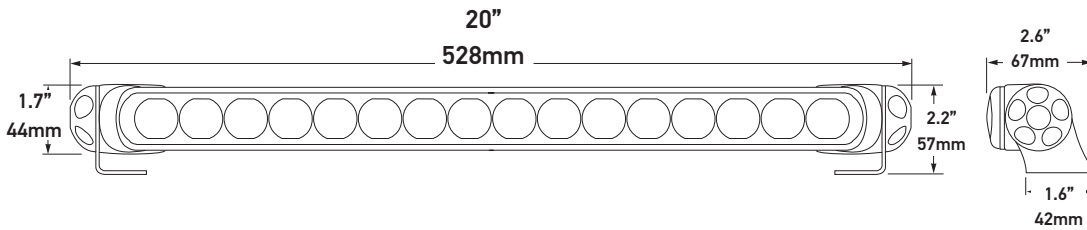

After the success of the HELLA LED Light Bar 350, HELLA is introducing the longer and brighter brother, the LED Light Bar 470. The new Light Bar features all the outstanding properties of the previous model plus an additional four high performance automotive LEDs and a maximum luminous intensity of 166,000 candela at a power consumption of only 35 watts. Weighing only 2lbs (950g) the Light Bar is particularly popular for roof mount applications on ATV's and Off-road vehicles.

Features:

- Lightweight at only 2lbs (950 g)
- 2800 measured lumens
- With 16 intensely bright high-power LEDs
- Reverse polarity and transient spike protection
- Connection: Wire leads
- 35 Watt, 9 - 33V (Multivolt)

Mounting:

- Horizontal mounting
- Pendant mounting

Applications:

- Long Range
- Off road use (Driving and Pencil beam versions ECE approved)
- Trucks / SUVs / ATVs / UTVs / Off-road vehicles

LIGHT DISTRIBUTION:

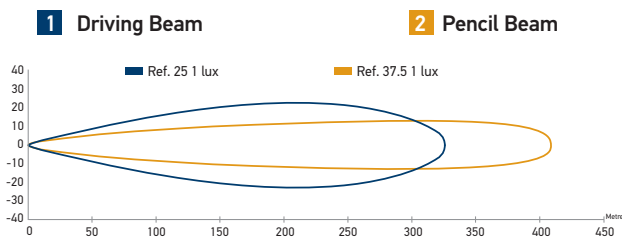

SPECIFICATIONS

Mounting	Upright or pendant.
Voltage	Multivolt™ for optimum brightness at input voltages from 9 to 33 volts.
Protection	Reverse polarity and transient spike protection. IP 6K7 (Protection against dust and temporary water immersion) IP 6K9K (Protection against dust and high-pressure/steam jet cleaning)
Cable Length	Pre-wired with 8ft (2.5m) of tinned multi-core cable.

CONTENTS

1 x LED Light Bar 470 2 x HD mounting brackets 1 x Mounting instructions



Part Number

LED light bar 470 - Driving Beam ECE approved	958130112
LED light bar 470 - Pencil Beam ECE approved	958130012

Accessories

Stainless Steel Dual Bracket compatible with 350 and 470 Light Bars	Part Number
Dual Bracket	958128811

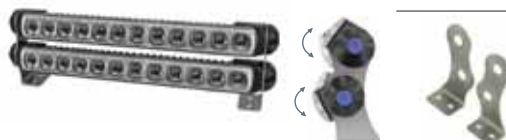

HELLA LED LIGHT BAR 350

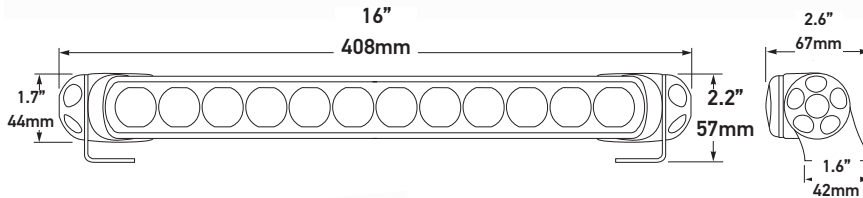

Features:

- Lightweight at only 1.7 lbs (790 g)
- Two intensity light settings for Wide and Narrow Beam versions
- 1500 Lumens for Driving and Pencil Beam versions
- 2200 Lumens for Wide and Narrow Beam versions (on 'High' setting)
- 220 Lumens for Wide and Narrow Beam versions (on 'Low' setting)
- With 12 intensely bright high-power LEDs
- Connection: Wire leads
- 25 Watt, 9 - 33V (Multivolt)

Mounting:

- Horizontal mounting
- Pendant mounting

Applications:

- Long Range
- Off road use (Driving and Pencil beam versions
ECE approved and street legal in Canada)
- Trucks / SUVs / ATVs / UTVs / Off-road vehicles

LIGHT DISTRIBUTION:

- 1** Driving Beam
- 2** Pencil Beam
- 3** Wide Beam
- 4** Narrow Beam

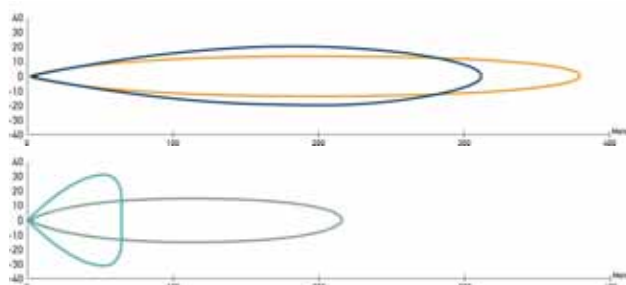

SPECIFICATIONS

Mounting	Upright or pendant.
Voltage	Multivolt™ for optimum brightness at input voltages from 9 to 33 volts.
Protection	Reverse polarity and transient spike protection. IP 6K7 (Protection against dust and temporary water immersion) IP 6K9K (Protection against dust and high-pressure/steam jet cleaning)
Cable Length	Pre-wired with 8ft (2.5m) of tinned multi-core cable.









CONTENTS

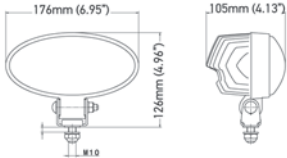
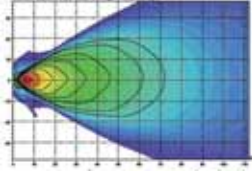

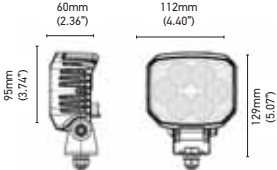
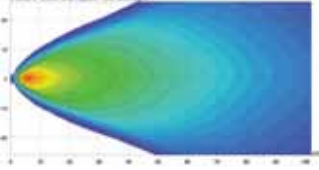
1 x LED Light Bar 350 2 x HD mounting brackets 1 x Mounting instructions

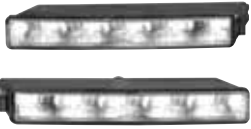
Part Number

LED light bar 350 - Driving Beam ECE approved	958040071
LED light bar 350 - Pencil Beam ECE approved	958040081
LED light bar 350 - Wide Beam with dimming function	958040521
LED light bar 350 - Narrow Beam with dimming function	958040641

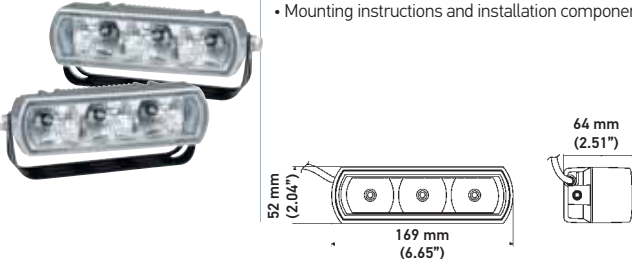

Product Image / Dimensions	Features	Technical specifications	Part Number
<p>FF300 LED</p> 	<p>LED</p> <ul style="list-style-type: none"> • 10 high performance LEDs • Low power consumption • Water and dust resistant • Protected against reverse polarity and over heating <p>Content:</p> <ul style="list-style-type: none"> • (1) LED headlight • Mounting instructions and installation components  	<ul style="list-style-type: none"> • Voltage: 9-33 VDC • Light output (measured): 2200 lumens • Light pattern: Driving beam • Power Consumption: 28 Watt • Color temperature: 6500 Kelvin • Housing material: Aluminum • Lens material: PMMA • Mounting: Stainless steel bracket • Mounting Type: Horizontal / Hanging • Connection: Wire leads 	<p>358116771 Single</p> 
<p>MICRO FF LED</p> 	<p>LED</p> <ul style="list-style-type: none"> • 6 high performance LEDs • Free form technology • Water and dust resistant • Protected against reverse polarity and over heating <p>Content:</p> <ul style="list-style-type: none"> • (1) LED headlight • Mounting instructions and installation components  	<ul style="list-style-type: none"> • Voltage: 9-33 VDC • Light output (measured): 1500 lumens • Light pattern: Driving beam • Power Consumption: 22 Watt • Color temperature: 6500 Kelvin • Housing material: Aluminum • Lens material: PMMA • Mounting: Stainless steel bracket • Mounting Type: Horizontal / Hanging • Connection: Wire leads (200 mm) with DT connector 	<p>358115981 Single</p> <p>Accessories:</p> <ul style="list-style-type: none"> • Wire harness (DT): H84985241 
<p>LEDAYLINE LED DAYTIME RUNNING LIGHTS</p> 	<p>LED</p> <ul style="list-style-type: none"> • 5 high performance LEDs • Attractive, transparent glass design that combines with any auxiliary headlights. • Aluminum housing • Compatible with SAE / DOT • Installation without problems through various options <p>Kit - Content:</p> <ul style="list-style-type: none"> • (2) LED headlights with brackets • (1) Control unit with wire harness • Mounting instructions and installation components 	<ul style="list-style-type: none"> • Voltage: 9-33 VDC • Light pattern: DRL position light • Power Consumption: 6 Watt • Color temperature: 6500 Kelvin • Housing material: PC • Lens material: Glass • Mounting Type: Flush • Connection: Wire harness with AMP connector • Approval: ECE / SAE 	<p>010043801 Kit</p>
<p>LEDAYLINE 15° Y 30° DAYTIME RUNNING LIGHTS</p> 	<p>LED</p> <ul style="list-style-type: none"> • 8 high performance LEDs (each) • Angled to fit the profile of the curved bumper • Hard UV resistant • Low energy consumption • Easy installation <p>Kit - Content:</p> <ul style="list-style-type: none"> • (2) lamps, (2) mounting brackets, (1) relay • Universal mounting hardware • Assembly instructions • (1) Control unit with wire harness • Mounting instructions and installation components 	<ul style="list-style-type: none"> • Voltage: 12 V • Light pattern: DRL position light • Power Consumption: 2 Watt • Color temperature: 6500 Kelvin • Housing material: PC • Lens material: PVC • Mounting Type: Flush • Connection: Wire harness with AMP connector • Approval: ECE / SAE 	<p>980850801 Kit - 30°</p> <p>980860801 Kit - 15°</p> 

Product Image / Dimensions	Features	Technical specifications	Part Number
<p>3 LED DAYTIME RUNNING LIGHTS</p> 	<p>LED</p> <ul style="list-style-type: none"> • 5 high performance LEDs • Attractive, transparent glass design that combines with any auxiliary headlight. • Installation without problems through various options <p>Kit - Content:</p> <ul style="list-style-type: none"> • (2) LED headlights with brackets • (1) Control unit with wire harness • Mounting instructions and installation components 	<ul style="list-style-type: none"> • Voltage: 9-33 VDC • Light pattern: DRL position light • Power Consumption: 5 Watt • Color temperature: 6500 Kelvin • Housing material: Aluminum • Lens material: Glass • Mounting Type: Vertical / Hanging • Connection: Wire harness with AMP connector • Approval: ECE / SAE 	<p>009496801 Kit</p> 

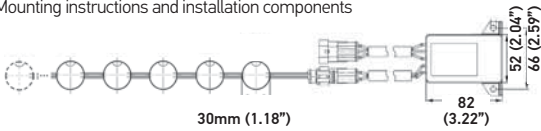
<p>LEDAY FLEX DAYTIME RUNNING LIGHTS</p> 	<p>LED</p> <ul style="list-style-type: none"> • LED daytime running lights set as position light • The set includes 2 modular chains with between 5 to 8 LED modules that can be configured in the vehicle front • Individual LED modules are circular and have a diameter of 1.1 "(30 mm) • Each module has a high power LED • The metal housing safely protects the lighting and electronics against waste way and also for heat dissipation • Connection through a 3-pole AMP system 	<ul style="list-style-type: none"> • Voltage: 9-33 VDC • Light pattern: DRL position light • Power Consumption: 15 Watt per modular chain • Color temperature: 6500 Kelvin • Housing material: Magnesium • Lens material: Glass • Mounting Type: Flush • Connection: Wire harness with AMP connector • Approval: ECE / SAE <p>Kit - Content:</p> <ul style="list-style-type: none"> • 2 LED Module Strings • 2 control units with wire harness • Mounting instructions and installation components 	<p>010458731 6 LEDs</p> 
--	--	---	--



Product Image / Dimensions	Features	Technical specifications	Part Number
----------------------------	----------	--------------------------	-------------

RALLYE 4000X LED
(REF. 37.5)

LED

- 2 high performance LED modules
- Dual reflector technology calculated by computer
- High quality metal housing
- Double reflector for a light beam pattern uniform that provides a excellent road lighting
- Low energy consumption
- Water and dust resistant

Content:
• (1) LED headlight, assembly instructions

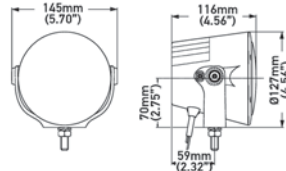

- Voltage: 10-32 VDC
- Light output (measured):: 1400 lumens
- Light pattern: Driving
- Power Consumption: 40 Watt
- Color temperature: 6000 Kelvin
- Housing material: Aluminum
- Lens material: PC
- Mounting Type: Horizontal
- Connection: 9.8 ft (3000mm) cable with open wires
- Approval: ECE

012206021

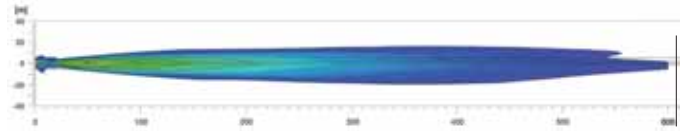

RALLYE 4000i COMPACT XENON
(REF. 37.5)

XENON

- Internal xenon reactance coil that facilitates the installation
- Compact design
- Powder paint: matt black
- Smooth lens with modern design
- Red ring

Content:
• (1) Headlight, (1) D1S xenon bulb
• Reactance coil: Integrated - Generation 4
• Cables, relay and components for installation (protective cover not included)

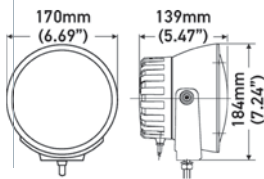

- Voltage: 12 VDC
- Light source: D1S xenon bulb
- Light pattern: Driving - Pencil beam
- Power Consumption: 35 Watt
- Housing material: Aluminum
- Lens material: Glass
- Mounting Type: Vertical / Driving
- Connection: Wire leads
- Approval: ECE - (N / A for Pencil beam)

009094331

Pencil beam

Replacement parts:

- Optical unit LA: 161825071
- Optical unit: 161825061







Accessories:

- White cover: 165048011
- Cable harness: H84994031

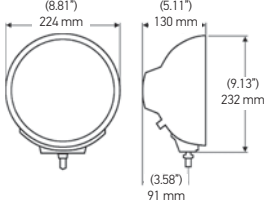
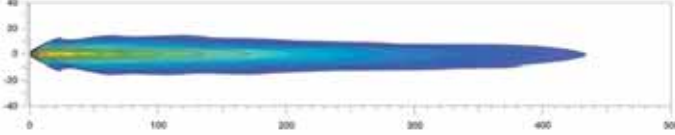

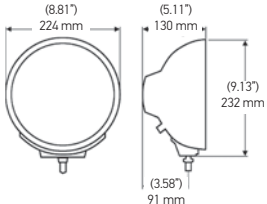
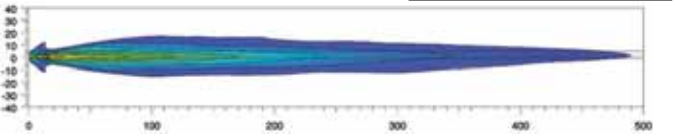

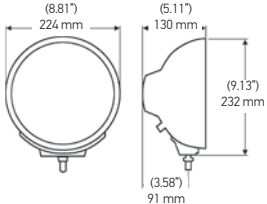
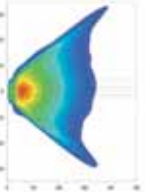
Pencil beam

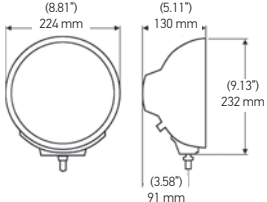
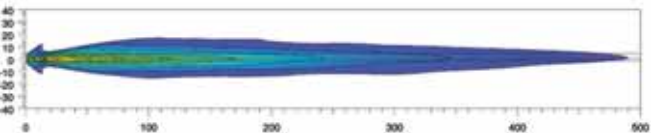

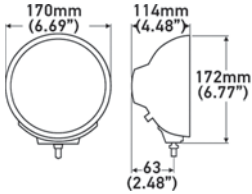
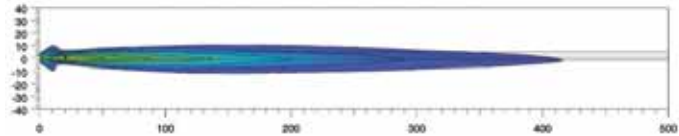

Product Image / Dimensions	Features	Technical specifications	Part Number
<p>RALLYE 4000 (REF. 37.5)</p> 	<p>HALOGEN</p> <ul style="list-style-type: none"> Tempered glass lens Cast zinc housing with matte black finish for the most extreme driving conditions Knurled buttons for quick adjustments of the light bulbs Change the appearance of any headlight with our protective covers Shieldz color <p>Content:</p> <ul style="list-style-type: none"> (1) headlight, (1) H1 12 V / 100 Watt bulb (1) Protective cover, (1) Connector Mounting instructions and installation components 	<ul style="list-style-type: none"> Voltage: 12 VDC Light source: H1 12 V / 100 Watt / T3-1 / 4 12 V / 5W Light pattern: Driving - Pencil - Curve light Driving with position light Power Consumption: 100 Watt Housing material: Zinc, Lens material: Glass Mounting type: Vertical Connection: Male connector, Approval: ECE (-031 only) <p>Color Shieldz Protective Foils:</p> <ul style="list-style-type: none"> Clear - H87988451, Yellow - H87988351 Blue - H87988341, Smoked - H87988361 	<p>007560931 Driving</p> <p>007560941 Driving + Position Light</p> <p>007560921 Light for curves</p> <p>007560951 Pencil beam</p> <p>Replacement parts:</p> <ul style="list-style-type: none"> White cover 147945001 H1 12 V/100W bulb: H1 100W <p>Accessories:</p> <ul style="list-style-type: none"> Clear cover H87988131 Protective grill 148995001 Harness cables 148541001
<p>RALLYE 4000 CHROME (REF. 37.5)</p> 	<p>HALOGEN</p> <ul style="list-style-type: none"> Glass lens with chromed metal housing high gloss Knurled knobs for quick adjustments of the light bulb Designed for driving conditions extreme <p>Content:</p> <ul style="list-style-type: none"> (1) Headlight, (1) H1 12V / 100W bulb + bulb for T3-1 / 4 12V / 5W (W5W) position light (1) Protective cover and Pigtail connector Mounting instructions and installation components 	<ul style="list-style-type: none"> Voltage: 12 VDC Light source: H1 12 V/100 Watt / T3-1 / 4 12 V/5W (W5W) Light pattern: Driving Power Consumption: 100 Watt Housing material: Zinc Lens material: Glass Mounting Type: Vertical Connection: Pigtail Connector Approval: ECE 	<p>007560911</p> <p>Replacement parts:</p> <ul style="list-style-type: none"> White cover: 147945001 H1 12 V/100W bulb: H1 100W T3-1/4 12 V/5W (W5W) Reflector Unit: 148131011 <p>Accessories:</p> <ul style="list-style-type: none"> White cover: H87988131 Protective grill: 148995001 Cable harness: 149147001 Harness 2 lamps: H84994031
<p>RALLYE 4000 FOG LIGHT</p> 	<p>HALOGEN</p> <ul style="list-style-type: none"> Tempered glass lens Cast zinc housing with matte black finish Knurled knobs for quick adjustments of the light bulb Designed for driving conditions more extreme <p>Content:</p> <ul style="list-style-type: none"> (1) Headlight, (1) H3 12V / 55W halogen bulb (1) Protective cover and Pigtail connector Mounting instructions and installation components 	<ul style="list-style-type: none"> Voltage: 12 VDC Light source: H3 12 V / 55W Light pattern: Fog Power Consumption: 55 Watt Housing material: Zinc Lens material: Glass Mounting Type: Vertical Connection: Pigtail Connector Approval: ECE / SAE 	<p>007560901</p> <p>Replacement parts:</p> <ul style="list-style-type: none"> White cover: 147945001 H3 12 V/55W bulb: H3 Reflector unit: 148131011 <p>Accessories:</p> <ul style="list-style-type: none"> Clear cover: H87988131 Protective grill: 148995001 Cable harness: 149147001 Harness 2 lamps: H84994031 <p>Color Shieldz Protective Foils:</p> <ul style="list-style-type: none"> Clear H87988451 Blue H87988351 Smoked H87988361
<p>RALLYE 4000 FF (REF. 37.5)</p> 	<p>HALOGEN</p> <ul style="list-style-type: none"> Free form glass lens Cast zinc housing with matte black finish Knurled knobs for quick adjustments of the light bulb Designed for driving conditions more extreme <p>Content:</p> <ul style="list-style-type: none"> (1) Headlight, (1) H1 Bulb 12 V / 55 Watt + bulb for T3-1 / 4 12V / 5W (W5W) position light (1) Protective cover and Pigtail connector Mounting instructions and installation components 	<ul style="list-style-type: none"> Voltage: 12 VDC Light source: H1 12 V/55 Watt / T3-1/4 12 V / 5W (W5W) Light pattern: Driving Power Consumption: 55 Watt Housing material: Zinc Lens material: Glass Mounting Type: Vertical Connection: Male connector Approval: ECE 	<p>007560361</p> <p>Replacement parts:</p> <ul style="list-style-type: none"> White cover: 147945001 H1 12 V/55W bulb: H1 T3-1/4 12 V/5W (W5W) Reflector unit: 148131011 <p>Accessories:</p> <ul style="list-style-type: none"> Clear cover: H87988131 Protective grill: 148995001 Cable harness: 148541001

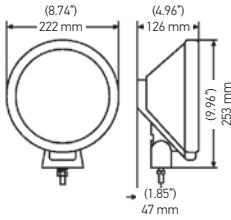
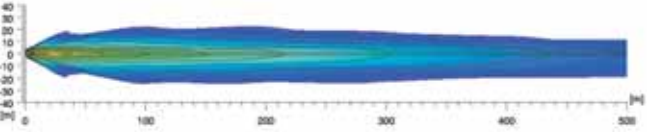

Product Image / Dimensions	Features	Technical specifications	Part Number
RALLYE 4000 COMPACT (REF. 37.5) 	HALOGEN <ul style="list-style-type: none"> Optimized free form reflector Transparent glass design 24% smaller than the Rally 4000 CELIS LED circular position light (009094191) <p>Content:</p> <ul style="list-style-type: none"> (1) Headlight, (1) H1 12 V / 55 Watt bulb (not included in -101) (1) Protective cover (not included in -101) Mounting instructions and installation components * Cable harness sold separately 	<ul style="list-style-type: none"> Voltage: 12 VDC Light source: H1 12 V / 55 Watt Light pattern: Driving - Long range Power Consumption: 55 Watt Housing material: Cast zinc housing with matte black finish Lens material: Glass Mounting Type: Vertical Connection: Wire leads Approval: ECE (-081 only) 	009094101 Long range 009094181 Driving
			<p>Replacement parts:</p> <ul style="list-style-type: none"> White cover: 165048001 H1 12 V/55W bulb: H1 Reflector unit ECE: 161825031 Reflector unit ECE/SAE: 161825011 <p>Accessories:</p> <ul style="list-style-type: none"> Clear cover: H87988221 Cable harness: H84994031 

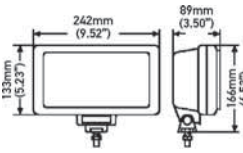
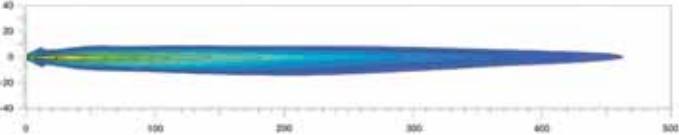
RALLYE 3000 BLUE (REF. 37.5) 	HALOGEN <ul style="list-style-type: none"> Blue glass lens - the light beam looks white when it lights Optimized free form reflector Black ABS housing with silver ring with design blue stripes <p>Content:</p> <ul style="list-style-type: none"> (1) Headlight (1) Pigtail Connector Mounting instructions and installation components 	<ul style="list-style-type: none"> Voltage: 12 VDC Light pattern: Driving Light source: H1 12 V/55 Watt - T3-1/4 12 V/5W (W5W) Power Consumption: 55 Watt Housing material: ABS (housing) Lens material: Glass Mounting: Zinc coated steel bracket Mounting Type: Vertical Connection: Pigtail Approval: ECE 	006800901
			<p>Replacement parts:</p> <ul style="list-style-type: none"> T3-1/4 12V/5W 2825 Reflector unit ECE: 157042011 Pigtail: H84994031 <p>Accessories:</p> <ul style="list-style-type: none"> Bombillo H1 12/55W H1 White cover: 142700001 Cable harness: H84994031 

JUMBO 220 (REF. 37.5) 	HALOGEN <ul style="list-style-type: none"> Classic design Black impact resistant housing and ring retention Glass lens Traditional design, the ideal complement to trucks and SUVs <p>Content:</p> <ul style="list-style-type: none"> (1) headlight, (1) H3 12 V / 55 Watt bulb (1) protective cover Mounting instructions and installation components 	<ul style="list-style-type: none"> Voltage: 12 VDC Light source: H3 12 V / 55 Watt Light pattern: Driving Power Consumption: 55 Watt Housing material: ABS (housing) Lens material: Glass Mounting: Zinc coated steel bracket Mounting Type: Vertical / Hanging Connection: Without cables Approval: ECE / SAE 	006300921 Driving
			<p>Replacement parts:</p> <ul style="list-style-type: none"> H3 12 V/55W bulb: H3 <p>Accessories:</p> <ul style="list-style-type: none"> White cover: 138127001 Cable harness: H84994031 

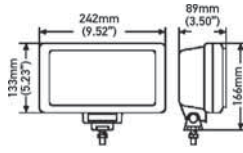
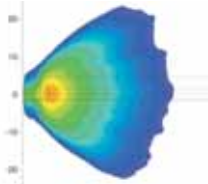
JUMBO 220 FOG LIGHT 	HALOGEN <ul style="list-style-type: none"> Classic design for fog conditions Black impact resistant housing and ring retention Glass lens Traditional design, the ideal complement to trucks and SUVs <p>Content:</p> <ul style="list-style-type: none"> (1) headlight, (1) H3 12 V / 55 Watt bulb (1) protective cover Mounting instructions and installation components 	<ul style="list-style-type: none"> Voltage: 12 VDC Light source: H3 12 V / 55 Watt Light pattern: Fog Power Consumption: 55 Watt Housing material: ABS (housing) Lens material: Glass Mounting: Zinc coated steel bracket Mounting Type: Vertical / Hanging Connection: Without cables Approval: ECE / SAE 	006300911
			<p>Replacement parts:</p> <ul style="list-style-type: none"> H3 12 V/55W bulb: H3 <p>Accessories:</p> <ul style="list-style-type: none"> White cover: 138127001 Cable harness: H84994031 

HELLA 500 SERIES



The art of lighting with an innovative reflector with free form technology

The HELLA 500, 500FF 700FF halogen auxiliary lamp series can easily be installed on the roof or on the front apron of the vehicles. They are perfectly equipped to withstand extreme driving situations. That not only sounds good, it also looks good: Compact design and black housing with matte finish.







In terms of lighting technology, these auxiliary lamps offer the following features a classic 500 and 700 series lamp design: A homogeneous illumination that, with the help of the computer-optimized free-form reflector, provides excellent visibility and active safety in extreme weather and driving conditions.



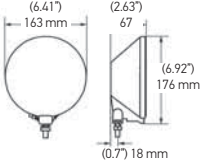
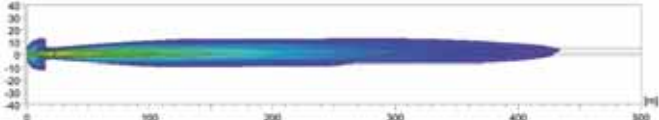

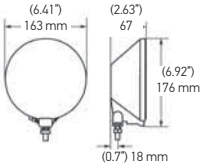
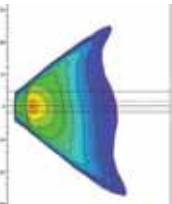

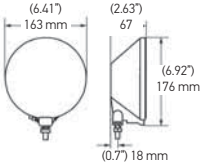
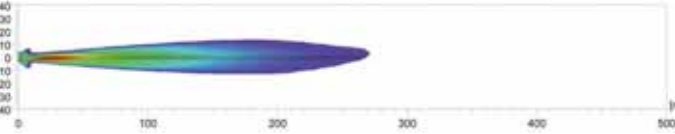
All HELLA 500, 500FF and 700FF series auxiliary lamps include:

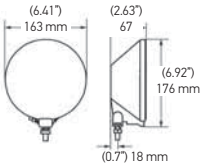
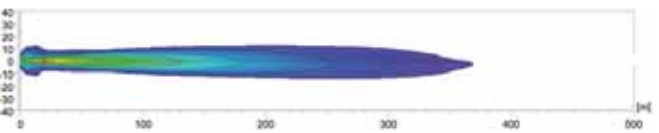
- 2 Halogen driving lights
- 2 Bulbs of 12 V / 55 Watt.
- 2 protective covers.
- 1 Relay 12 V, 1 Switch
- Wire harness, mounting brackets and assembly instructions.

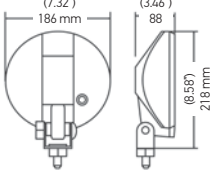
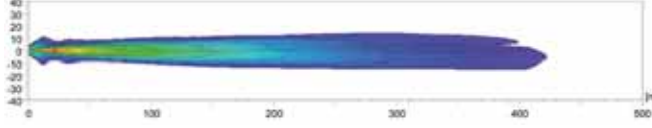

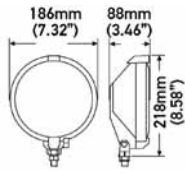

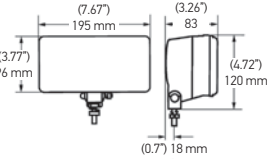

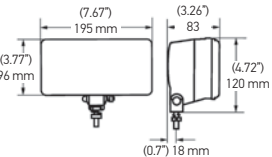
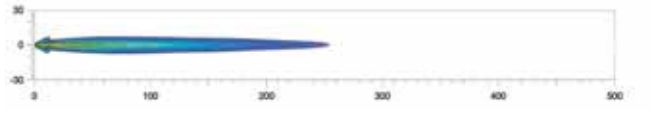

Product Image / Dimensions	Features	Technical specifications	Part Number
<p>HELLA 500 (REF. 37.5)</p> 	<p>HALOGEN</p> <ul style="list-style-type: none"> Lightweight design Impact resistant ABS housing Aluminum vapor coated reflector Glass lens <p>Single - Content:</p> <ul style="list-style-type: none"> (1) Headlight, (1) H3 12 V / 55 Watt bulb (1) protective cover Mounting instructions and installation components <p>Kit - Content:</p> <ul style="list-style-type: none"> (2) Headlights, (2) H3 12V / 55W bulbs, (1) wire harness (2) Protective covers, (1) switch, (1) relay Mounting instructions and installation material 	<ul style="list-style-type: none"> Voltage: 12 VDC Light source: H3 12 V / 55 Watt Light pattern: Driving Power Consumption: 55 Watt Housing material: ABS (housing) Lens material: Glass Mounting: Zinc coated steel braket Mounting Type: Vertical / Hanging Connection: Wire leads Approval: ECE <p>Change the appearance of any headlight in the series HELLA 500 with Shield protective films available in: yellow, smoky and blue tones</p> 	<p>005750411 Single</p> <p>005750952 Kit</p> <p>005750512 Single - amber</p> <p>Replacement parts:</p> <ul style="list-style-type: none"> H3 12/55W bulb: H3 Relay 12 V/15A: 003530001 LED switch (green): H61923001 <p>Accessories:</p> <ul style="list-style-type: none"> White cover: 135236021 Black cover: H73146011 Clear cover: H87988081 Protective grill: 165530801 Cable harness: H84994031
<p>HELLA 500 FOG LIGHT (REF. 12.5)</p> 	<p>HALOGEN</p> <ul style="list-style-type: none"> Lightweight design Impact resistant ABS housing Aluminum vapor coated reflector Change the appearance of any headlight in the HELLA 500 with Shield protective films available in yellow, smoky, or blue tones Glass lens <p>Kit - contains:</p> <ul style="list-style-type: none"> (2) Headlights, (2) H3 12V / 55W bulbs, (1) wire harness (2) Protective covers, (1) switch, (1) relay Mounting instructions and installation material 	<ul style="list-style-type: none"> Voltage: 12 VDC Light source: H3 12 V / 55 Watt Light pattern: Fog Power Consumption: 55 Watt Housing material: ABS (housing) Lens material: Glass Mounting: Zinc coated steel brake Mounting Type: Vertical Connection: Wire leads Approval: ECE / SAE 	<p>005750971 Kit</p> <p>Replacement parts:</p> <ul style="list-style-type: none"> H3 12/55W bulb: H3 Relay 12 V/15A: 003530001 LED switch (green): H61923001 <p>Accessories:</p> <ul style="list-style-type: none"> White cover: 135236021 Black cover: H73146011 Clear cover: H87988081 Protective grill: 165530801 Cable harness: H84994031
<p>HELLA 500 BLACK MAGIC</p> 	<p>HALOGEN</p> <ul style="list-style-type: none"> Lightweight design Impact resistant ABS housing Aluminum vapor coated reflector The innovative black optics technology creates a only appearance when off. Glass lens <p>Kit - Content:</p> <ul style="list-style-type: none"> (2) Headlights, (2) H3 12V / 55W bulbs, (1) wire harness (2) Protective covers, (1) switch, (1) relay Mounting instructions and installation material 	<ul style="list-style-type: none"> Voltage: 12 VDC Light source: H3 12 V / 55 Watt Light pattern: Driving Power Consumption: 55 Watt Housing material: ABS (housing) Lens material: Glass Mounting: Zinc coated steel with black finish braket Mounting Type: Vertical Connection: Wire leads Approval: SAE 	<p>005750991 Kit</p> <p>Replacement parts:</p> <ul style="list-style-type: none"> H3 12/55W bulb: H3 Relay 12 V/15A: 003530001 LED switch (green): H61923001 <p>Accessories:</p> <ul style="list-style-type: none"> Black cover: H73146011 Clear cover: H87988081 Protective grill: 165530801 Cable harness: H84994031
<p>HELLA 500FF (REF. 37.5)</p> 	<p>HALOGEN</p> <ul style="list-style-type: none"> Lightweight design Impact resistant ABS housing Aluminum vapor coated reflector with free form technology with glass lens <p>Single - Content:</p> <ul style="list-style-type: none"> (1) headlight, (1) H3 12 V / 55W bulb (1) protective cover Mounting instructions and installation components <p>Kit - Content:</p> <ul style="list-style-type: none"> (2) Headlights, (2) H3 12V / 55W bulbs, (1) wire harness (2) Protective covers, (1) switch, (1) relay Mounting instructions and installation material 	<ul style="list-style-type: none"> Voltage: 12 VDC Light source: H3 12 V / 55 Watt Light pattern: Driving Power Consumption: 55 Watt Housing material: ABS (housing) Lens material: Glass Mounting: Zinc coated steel braket Mounting Type: Vertical Connection: Wire leads Approval: ECE 	<p>005750401 Single</p> <p>005750941 Kit</p> <p>Replacement parts:</p> <ul style="list-style-type: none"> H3 12/55W bulb: H3 Relay 12 V/15A: 003530001 LED switch (green): H61923001 <p>Accessories:</p> <ul style="list-style-type: none"> Black Cover: H73146011 Clear cover: H87988081 Protective grill: 165530801 Cable harness: H84994031

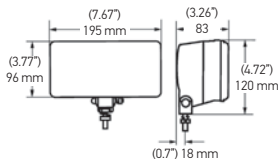
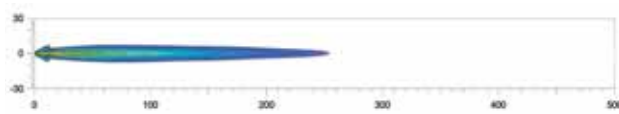
Product Image / Dimensions	Features	Technical specifications	Part Number
<p>HELLA 700FF (REF. 37.5)</p> 	<p>HALOGEN</p> <ul style="list-style-type: none"> • Lightweight design • Impact resistant ABS housing • Aluminum vapor coated reflector with free form technology with glass lens <p>Single - Content:</p> <ul style="list-style-type: none"> • (1) headlight, (1) bulb H3 12 V / 55 Watt • (1) protective cover • Mounting instructions and installation components <p>Kit - Content:</p> <ul style="list-style-type: none"> • (2) Headlights, (2) H3 12V / 55W bulbs, • (1) wire harness • (2) Protective covers, (1) switch, (1) relay • Mounting instructions and installation material 	<ul style="list-style-type: none"> • Voltage: 12 VDC • Light source: H3 12 V / 55 Watt • Light pattern: Driving • Power Consumption: 55 Watt • Housing material: ABS (housing) • Lens material: Glass • Mounting: Zinc coated steel bracket • Mounting Type: Vertical • Connection: Wire leads • Approval: ECE 	<p>010032001 Single</p> <p>Replacement parts:</p> <ul style="list-style-type: none"> • H3 12/55W bulb: H3 • Relay 12 V/15A: H84994031 • LED switch (green): H61923001 <p>Accessories:</p> <ul style="list-style-type: none"> • White cover: 173147001 • Cable harness: H84994031 
<p>HELLA 1000 BLACK MAGIC (REF. 17.5)</p> 	<p>HALOGEN</p> <ul style="list-style-type: none"> • Super thin design • Impact resistant ABS housing • Aluminum vapor coated reflector • The innovative black optics technology creates a only appearance when off <p>Single - Content:</p> <ul style="list-style-type: none"> • (1) headlight, (1) H2 bulb • (1) Protective cover and Mounting instructions <p>Kit - Content:</p> <ul style="list-style-type: none"> • (2) Headlights, (2) H2 12 V / 55 Watt bulbs, • (1) wire harness, (2) Protective covers, (1) switch, (1) relay, mounting instructions and components 	<ul style="list-style-type: none"> • Voltage: 12 VDC • Light source: H2 12 V / 55 Watt • Light pattern: Driving • Power Consumption: 55 Watt • Housing material: ABS (housing) • Lens material: Glass • Mounting: Zinc coated steel bracket • Mounting Type: Vertical • Connection: Wire leads • Approval: ECE 	<p>004700431 Single</p> <p>004700771 Kit</p> <p>Replacement parts:</p> <ul style="list-style-type: none"> • H2 12/55W bulb: H2 • Relay 12 V/15A: 003530001 <p>Accessories:</p> <ul style="list-style-type: none"> • White cover: 130331001 • Clear cover: H87988121 • Cable harness: H84994031
<p>HELLA 550 (REF. 17.5)</p> 	<p>HALOGEN</p> <ul style="list-style-type: none"> • Lightweight design • Impact resistant ABS housing • Aluminum vapor coated reflector and glass lens <p>Single - Content:</p> <ul style="list-style-type: none"> • (1) headlight, 1 bulb H3 12 V / 55 Watt • (1) Protective cover and Mounting instructions <p>Kit - Content:</p> <ul style="list-style-type: none"> • (2) Headlights, (2) H2 12 V / 55 Watt bulbs, • (1) wire harness • (2) Protective covers, (1) switch, (1) relay • Mounting instructions and installation components 	<ul style="list-style-type: none"> • Voltage: 12 VDC • Light source: H3 12 V / 55 Watt • Light pattern: Driving • Power Consumption: 55 Watt • Housing material: ABS (housing) • Lens material: Glass • Mounting: Zinc coated steel bracket • Mounting Type: Vertical / Hanging • Connection: Without cables • Approval: ECE / SAE 	<p>005700471 Single</p> <p>005700891 Kit</p> <p>Replacement parts:</p> <ul style="list-style-type: none"> • H3 12/55W bulb: H3 • LED switch (green): H61923001 <p>Accessories:</p> <ul style="list-style-type: none"> • White cover: H87037001 • Clear cover: H87988111 • Cable harness: H84994031
<p>HELLA 550 FOG LIGHT</p> 	<p>HALOGEN</p> <ul style="list-style-type: none"> • Lightweight design • Impact resistant ABS housing • Aluminum vapor coated reflector • Glass lens <p>Single - Content:</p> <ul style="list-style-type: none"> • (1) Headlight, 1 H3 12 V / 55 Watt bulb • (1) Protective cover and Mounting instructions <p>Kit - Content:</p> <ul style="list-style-type: none"> • (2) Headlights, (2) H2 12 V / 55 Watt bulbs, • (1) wire harness • (2) Protective covers, (1) switch, (1) relay • Mounting instructions and installation components 	<ul style="list-style-type: none"> • Voltage: 12 VDC • Light source: H3 12 V / 55 Watt • Light pattern: Fog • Power Consumption: 55 Watt • Housing material: ABS (housing) • Lens material: Glass • Mounting: Zinc coated steel bracket • Weight: 1200 g • Mounting Type: Vertical / Hanging • Connection: Without cables • Approval: ECE / SAE 	<p>005700441 Single</p> <p>Replacement parts:</p> <ul style="list-style-type: none"> • H3 12/55W bulb: H3 • LED switch (green): H61923001 <p>Accessories:</p> <ul style="list-style-type: none"> • White cover: H87037001 • Clear cover: H87988111 • Cable harness: H84994031 







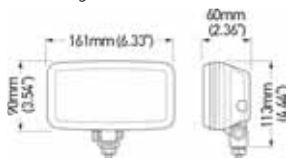
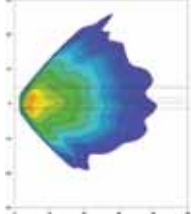

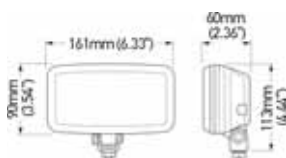
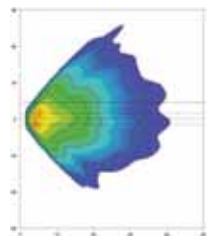

Product Image / Dimensions	Features	Technical specifications	Part Number
<p>HELLA 550 FOG LIGHT / AMBER</p> 	<p>HALOGEN</p> <ul style="list-style-type: none"> Lightweight design Impact resistant ABS housing Aluminum vapor coated reflector Classic design <p>Single - Content:</p> <ul style="list-style-type: none"> (1) headlight, (1) H3 12 V / 55W bulb (1) Protective cover and Mounting instructions <p>Kit - Content:</p> <ul style="list-style-type: none"> (2) Headlights, (2) H3 12V / 55W bulbs, (1) wire harness (2) Protective covers, (1) switch, (1) relay Mounting instructions and installation components 	<ul style="list-style-type: none"> Voltage: 12 VDC Light source: H3 12 V / 55W Light pattern: Fog Power Consumption: 55 Watt Housing material: ABS (housing) Lens material: Glass Mounting: Zinc coated steel bracket Mounting Type: Vertical / Hanging Connection: Without cables Approval: ECE / SAE 	<p>005700421 Single</p> <p>Replacement parts:</p> <ul style="list-style-type: none"> H3 12/55W bulb: H3 LED switch (green): H61923001 <p>Accessories:</p> <ul style="list-style-type: none"> White cover: H87037001 Clear cover: H87988111 Cable harness: H84994031

<p>HELLA 450 (Ref. 17.5)</p> 	<p>HALOGEN</p> <ul style="list-style-type: none"> Impact resistant ABS housing Aluminum vapor coated reflector Classic design <p>Single - Content:</p> <ul style="list-style-type: none"> (1) headlight, (1) bulb H3 12 V / 55W (1) Protective cover and Mounting instructions <p>Kit - Content:</p> <ul style="list-style-type: none"> (2) Headlights, (2) H3 12V / 55W bulbs, (1) wire harness (2) Protective covers, (1) switch, (1) relay Mounting instructions and installation material 	<ul style="list-style-type: none"> Voltage: 12 VDC Light source: H3 12 V / 55 Watt Light pattern: Driving Power Consumption: 55 Watt Housing material: ABS (housing) Lens material: Glass Mounting: Zinc coated steel bracket Mounting Type: Vertical / Hanging Connection: Wire leads Approval: ECE / SAE 	<p>005860231 Single</p> <p>Replacement parts:</p> <ul style="list-style-type: none"> H3 12/55W bulbs: H3 <p>Accessories:</p> <ul style="list-style-type: none"> White cover: 131000011 Clear cover: H87988071 Cable harness: H84994031
--	--	--	---

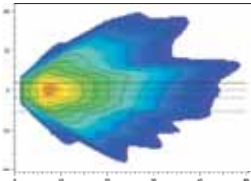
<p>HELLA 450 FOG LIGHT</p> 	<p>HALOGEN</p> <ul style="list-style-type: none"> Impact resistant ABS housing Aluminum vapor coated reflector with free form technology Glass lens <p>Single - Content:</p> <ul style="list-style-type: none"> (1) headlight, (1) H3 12 V / 55 Watt bulb (1) Protective cover and Mounting instructions <p>Kit - Content:</p> <ul style="list-style-type: none"> (2) Headlights, (2) H3 12V / 55W bulbs, (1) wire harness, (2) Protective covers, (1) switch, (1) relay Mounting instructions and installation components 	<ul style="list-style-type: none"> Voltage: 12 VDC Light source: H3 12 V / 55 Watt Light pattern: Fog Power Consumption: 55 Watt Housing material: ABS (housing) Lens material: Glass Mounting: Stainless steel bracket Mounting Type: Vertical Connection: Wire leads Approval: ECE / SAE 	<p>005860201 Single</p> <p>005860601 Kit</p> <p>Replacement parts:</p> <ul style="list-style-type: none"> H3 12/55W bulb: H3 Reflector unit: 137001021 <p>Accessories:</p> <ul style="list-style-type: none"> White cover: 131000011 Clear cover: H87988071 Cable harness: H84994031
---	--	--	---

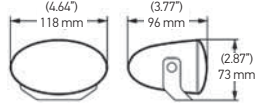
<p>HELLA 450 FOG LIGHT - AMBER</p> 	<p>HALOGEN</p> <ul style="list-style-type: none"> Lightweight design Impact resistant ABS housing Aluminum vapor coated reflector Glass lens <p>Single - Content:</p> <ul style="list-style-type: none"> (1) Headlight (1) H3 12V / 55W bulb (1) Protective cover Mounting instructions and installation components 	<ul style="list-style-type: none"> Voltage: 12 VDC Light source: H3 12 V / 55 Watt Light pattern: Fog Power Consumption: 55 Watt Housing material: ABS (housing) Lens material: Glass Mounting: Stainless steel bracket Mounting Type: Vertical / Hanging Connection: Wire leads Approval: ECE 	<p>005860221 Single</p> <p>Replacement parts:</p> <ul style="list-style-type: none"> H3 12/55W bulb: H3 <p>Accessories:</p> <ul style="list-style-type: none"> White cover: 137000011 Clear cover: H87988071 Cable harness: H84994031
--	---	--	--

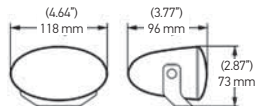
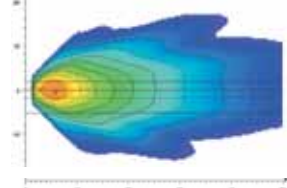
Product Image / Dimensions	Features	Technical specifications	Part Number
<p>FF 75 (REF. 12.5)</p> 	<p>HALOGEN</p> <ul style="list-style-type: none"> • Compact, long and flat design - convenient for tight spaces • Transparent glass lens / blue glass lens • Free form magnesium reflector for output optimal light • Magnesium offers a high thermal resistance that prevents deformation <p>Single - contains:</p> <ul style="list-style-type: none"> • (1) lamp, (1) H7 12 V / 55 Watt bulb • Mounting instructions and installation components <p>Kit - contains:</p> <ul style="list-style-type: none"> • (2) lamps, (2) H7 12 V / 55 Watt bulbs • (1) wire harness, (1) relay, (1) switch • Mounting instructions and installation components 	<ul style="list-style-type: none"> • Voltage: 12 VDC • Light source: H7 12 V / 55 Watt • Light pattern: Driving • Power Consumption: 55 Watt • Housing material: PVC • Lens material: Glass • Mounting: Stainless steel bracket • Mounting Type: Vertical / Hanging • Connection: Bulb connector • Approval: ECE / SAE 	<p>008284011 Single</p> <p>008284811 Kit</p> <p>Replacement parts:</p> <ul style="list-style-type: none"> • H7 12V / 55W bulb: H7 <p>Accessories:</p> <ul style="list-style-type: none"> • White cover: H87236051 • Clear cover: H87988011 • Cable harness: H84994031
<p>FF 75 FOG LIGHT</p> 	<p>HALOGEN</p> <ul style="list-style-type: none"> • Compact, long and flat design - convenient for tight spaces • Transparent glass lens • Free form magnesium reflector for output optimal light • Magnesium offers a high thermal resistance that prevents deformation <p>Single - contains:</p> <ul style="list-style-type: none"> • (1) lamp, (1) H7 12 V / 55 Watt bulb • Mounting instructions and installation components <p>Kit - contains:</p> <ul style="list-style-type: none"> • (2) lamps, (2) H7 12 V / 55 Watt bulbs • (1) wire harness, (1) relay, (1) switch • Mounting instructions and installation components 	<ul style="list-style-type: none"> • Voltage: 12 VDC • Light source: H7 12 V / 55 Watt • Light pattern: Fog • Power Consumption: 55 Watt • Housing material: PVC • Lens material: Glass • Mounting: Stainless steel bracket • Mounting Type: Vertical / Hanging • Connection: Bulb connector • Approval: ECE / SAE 	<p>008284001 Single</p> <p>008284801 Kit</p> <p>Replacement parts:</p> <ul style="list-style-type: none"> • H7 12/55W bulb: H7 <p>Accessories:</p> <ul style="list-style-type: none"> • White cover: H87236051 • Clear cover: H87988011 • Cable harness: H84994031
<p>FF 50 (REF. 12.5)</p> 	<p>HALOGEN</p> <ul style="list-style-type: none"> • Compact, long and flat design - convenient for tight spaces • Transparent glass lens / blue glass lens • Free form magnesium reflector for output optimal light • Magnesium offers a high thermal resistance that prevents deformation <p>Single - contains:</p> <ul style="list-style-type: none"> • (1) lamp, (1) H7 12 V / 55W bulb • Mounting instructions and installation components <p>Kit - contains:</p> <ul style="list-style-type: none"> • (2) lamps, (2) H7 12 V / 55W bulbs • (1) wire harness, (1) relay, (1) switch • Mounting instructions and installation components 	<ul style="list-style-type: none"> • Voltage: 12 VDC • Light source: H7 12 V / 55 Watt • Light pattern: Driving • Power Consumption: 55 Watt • Housing material: PVC • Lens material: Glass • Mounting: Stainless steel bracket • Mounting Type: Vertical / Hanging • Connection: Bulb connector • Approval: ECE / SAE 	<p>008283011 Single</p> <p>008283811 Kit</p> <p>Replacement parts:</p> <ul style="list-style-type: none"> • H7 12/55W bulb: H7 <p>Accessories:</p> <ul style="list-style-type: none"> • Clear cover: H87988001 • Cable harness: H84994031
<p>FF 50 FOG LIGHT</p> 	<p>HALOGEN</p> <ul style="list-style-type: none"> • Compact, long and flat design - convenient for tight spaces • Transparent glass lens / blue glass lens • Free form magnesium reflector for optimal light output. Magnesium offers a high thermal resistance that prevents deformation <p>Single - contains:</p> <ul style="list-style-type: none"> • (1) lamp, (1) H7 12 V / 55W bulb, manual installation instructions and components <p>Kit - contains:</p> <ul style="list-style-type: none"> • (2) lamps, (2) H7 12 V / 55W bulbs • (1) wire harness, (1) relay, (1) switch • Mounting instructions and installation components 	<ul style="list-style-type: none"> • Voltage: 12 VDC • Light source: H7 12 V / 55 Watt • Light pattern: Fog • Power Consumption: 55 Watt • Housing material: PVC • Lens material: Glass • Mounting: Stainless steel bracket • Mounting Type: Vertical / Hanging • Connection: Bulb connector • Approval: ECE / SAE 	<p>008283801 Kit</p> <p>Replacement parts:</p> <ul style="list-style-type: none"> • H7 12/55W bulb: H7 <p>Accessories:</p> <ul style="list-style-type: none"> • Clear cover: H87988001 • Cable harness: H84994031

90 MM LED MODULES

The new L4060 LED series is the new addition to the range of 90 millimeter LED modules. This makes HELLA the only supplier in the market to provide a replacement concept for all 90 millimeter halogen modules using LED technology. The design of the new module is very compact and allows three light functions in one module without additional electronics. The resistant cover plate of polycarbonate and the cast aluminum housing are extremely robust and can withstand even tougher loads. The new L4060 LED series give you more illumination and safety with innovative LED technology.

90 MM CONFIGURATOR

This tool shows you the options for equipping or upgrading a vehicle with 90 mm LED modules. See images from Europe's biggest light testing facility and compare the light distribution of halogen and LED modules, in order to help you make the right choice for your application.



www.hella.com/90mm-modules

90MM MODULES

Program Overview

- For the most diverse applications and for the most demanding needs
- Maximum technological and design freedom thanks to its modular system
- Increased lighting and safety thanks to innovative LED technology

	LED	Halogen (conventional lighting technology)
Main light functions	<ul style="list-style-type: none"> → Low beam and high beam (bi-modules) → Low beam → Low beam with daytime running light and position light → High beam → High beam with daytime running light and position light → High beam and direction indicator light 	<ul style="list-style-type: none"> → Low beam and high beam (bi-modules) → Low beam → High beam → High beam and position light
Auxiliary light functions	<ul style="list-style-type: none"> → Fog light → Fog light and cornering light → Fog light, daytime running light and position light → Daytime running light → Daytime running light and position light → Direction indicator light, daytime running light and position light 	<ul style="list-style-type: none"> → Fog light → Fog light and cornering light → Fog light and daytime running light → Daytime running light and position light → Position light → Direction indicator light and position light → Direction indicator light

90 mm modules

Configurator

Powerful, cost-efficient and modular. Put together your customised front lighting from our wide range of 90 mm modules.

www.hella.com/headlamp-modules



90 MM LED MODULES



Product Image / Dimensions	Features	Additional Information	Part Number
----------------------------	----------	------------------------	-------------

**L4060 LED
BI-LED GEN II
HIGH / LOW BEAM**

LED

- Headlight module
- Polycarbonate lens
- Cast aluminum housing
- Black finish cover
- Dipped beam: 20 Watt
- Voltage: 9 - 33 V
- Connection: DT connector
- Approval: SAE / ECE

Mounting:
• Flush



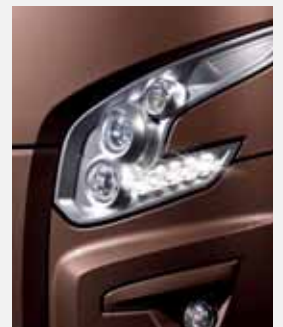
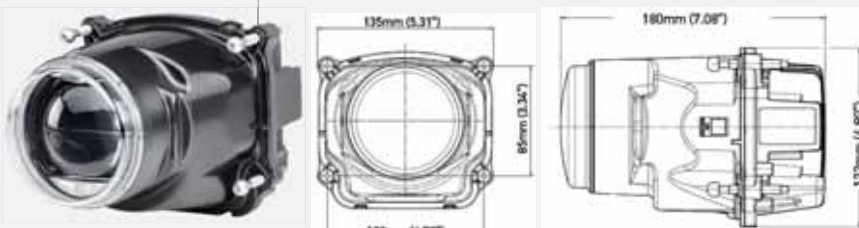

Applications:
• Universal application
• Headlight update

Content:
• 1 Headlights, Mounting instructions and installation components

012758121 Homologation SAE

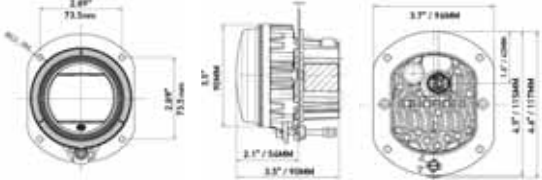



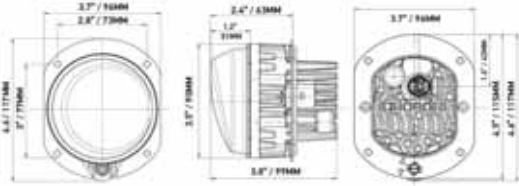

Product Image / Dimensions	Features	Additional Information	Part Number
<p>L4060 LED LED HIGH BEAM WITH DAYTIME RUNNING/ POSITION LIGHT</p>  <p>Pre-mounted carrier frame</p>	<p>LED</p> <ul style="list-style-type: none"> • Headlamp module with low beam, position and daylight (DRL) • Polycarbonate lens • Cast aluminum housing • Silver design cover • Black finish cover on request • Voltage: 9 - 32 VDC • Power Consumption: 20 Watt • Integrated 4-pin DT connector • Approval: ECE / SAE 	<p>Mounting:</p> <ul style="list-style-type: none"> • Flush <p>Applications:</p> <ul style="list-style-type: none"> • Universal application • Headlight update <p>Content:</p> <ul style="list-style-type: none"> • 1 Headlight, Mounting instructions and installation components 	<p>011988031 Pre-mounted carrier frame</p> <p>011988131 Performance mount</p> <p>202117001 DT conversion connector</p> 
<p>L4060 LED LED HIGH BEAM</p>  <p>Pre-mounted carrier frame</p>	<p>LED</p> <ul style="list-style-type: none"> • Headlight module • Polycarbonate lens • Cast aluminum housing • Silver design cover • Black finish cover on request • Voltage: 9 - 32 VDC • Power Consumption: 20 Watt • Integrated 4-pin FEP connector (Power connector DT conversion available - sold separately) • Approval: ECE / SAE 	<p>Mounting:</p> <ul style="list-style-type: none"> • Flush <p>Applications:</p> <ul style="list-style-type: none"> • Universal application • Headlight update <p>Content:</p> <ul style="list-style-type: none"> • 1 Headlight, Mounting instructions and installation components 	<p>011988021 Pre-mounted carrier frame</p> <p>011988121 Performance mount</p> <p>202117001 DT conversion connector</p> 
<p>L4060 LED LED HIGH BEAM WITH TURN SIGNAL</p> 	<p>LED</p> <ul style="list-style-type: none"> • Headlight module • Polycarbonate lens • Cast aluminum housing • Silver design cover • Black finish cover on request • Only for vehicles below 80" in width • Voltage: 9 - 32VDC • Power Consumption: 20 Watt • Integrated 4-pin FEP connector (Power connector DT conversion available - sold separately) • Approval: ECE / SAE 	<p>Mounting:</p> <ul style="list-style-type: none"> • Flush <p>Applications:</p> <ul style="list-style-type: none"> • Universal application • Headlight update <p>Content:</p> <ul style="list-style-type: none"> • 1 Headlight, Mounting instructions and installation components 	<p>011988071 With carrier frame without pulse generator</p> <p>011988171 Performance mount without pulse generator</p> <p>202117001 DT conversion connector</p> 
<p>L4060 LED FOG LIGHT WITH CURVE LIGHT</p> 	<p>LED</p> <ul style="list-style-type: none"> • Headlight module • Polycarbonate lens • Cast aluminum housing • Silver design cover • Black finish cover on request • Voltage: 9 - 32VDC • Power Consumption: 20 Watt • Integrated 4-pin FEP connector (Power connector DT conversion available - sold separately) • Approval: ECE / SAE 	<p>Mounting:</p> <ul style="list-style-type: none"> • Flush <p>Applications:</p> <ul style="list-style-type: none"> • Universal application • Headlight update <p>Content:</p> <ul style="list-style-type: none"> • 1 Headlight, Mounting instructions and installation components 	<p>011988051 Light Left Hand</p> <p>011988061 Light Right Hand</p> 

Product Image / Dimensions	Features	Additional Information	Part Number
L4060 LED LED FOG LIGHT 	LED <ul style="list-style-type: none"> • Headlight module • Polycarbonate lens • Cast aluminum housing • Silver design cover • Black finish cover on request • Voltage: 9 - 32 VDC • Power Consumption: 20 Watt • Integrated 4-pin FEP connector (Power connector DT conversion available - sold separately) • Approval: SAE 	Mounting: <ul style="list-style-type: none"> • Flush Applications: <ul style="list-style-type: none"> • Universal application • Headlight update Content: <ul style="list-style-type: none"> • (1) Headlight, Mounting instructions and installation components 	011988001 Pre-mounted carrier frame
			202117001 DT conversion connector

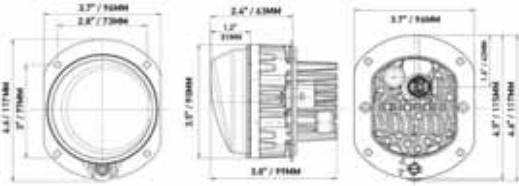

L4060 LED LED FOG LIGHT WITH DAYTIME RUNNING/ POSITION LIGHT 	LED <ul style="list-style-type: none"> • Headlight module • Polycarbonate lens • Cast aluminum housing • Silver design cover • Black finish cover on request • Voltage: 9 - 32 VDC • Power Consumption: 20 Watt • Integrated 4-pin FEP connector (Power connector DT conversion available - sold separately) • Approval: SAE 	Mounting: <ul style="list-style-type: none"> • Flush Applications: <ul style="list-style-type: none"> • Universal application • Headlight update Content: <ul style="list-style-type: none"> • (1) Headlight, Mounting instructions and installation components 	011988011 Pre-mounted carrier frame
			202117001 DT conversion connector

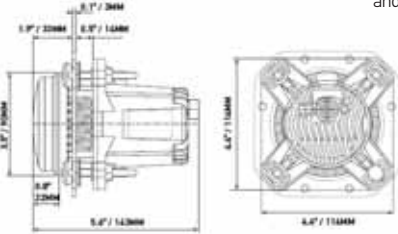

L4060 LED LED LOW BEAM 	LED <ul style="list-style-type: none"> • Headlight module • Polycarbonate lens • Cast aluminum housing • Silver design cover • Voltage: 9 - 32 VDC • Power Consumption: 20 Watt • Integrated DT connector • Approval: SAE / ECE 	Mounting: <ul style="list-style-type: none"> • Flush Applications: <ul style="list-style-type: none"> • Universal application • Headlight update Content: <ul style="list-style-type: none"> • (1) Headlight, Mounting instructions and installation components 	012488101
			012488121 With Daytime Running /Position Light



90 MM LED - ACCESSORIES AND SPARE PARTS

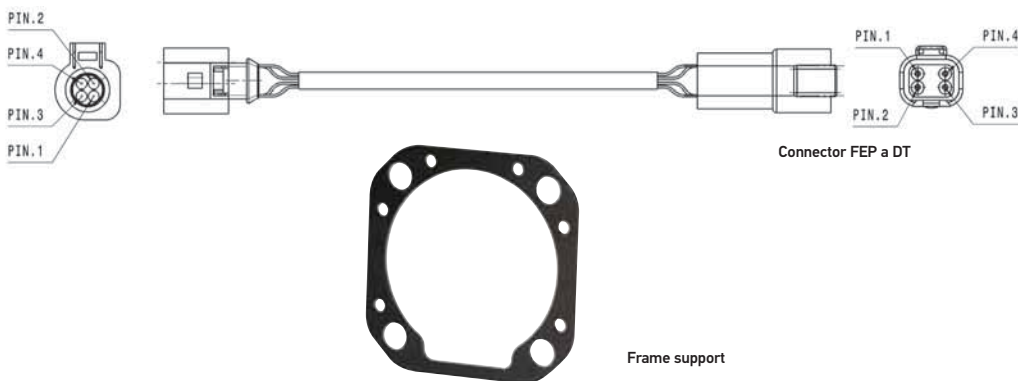

169580011	Frame support
202117001	FEP to DT connector

R 80 LED

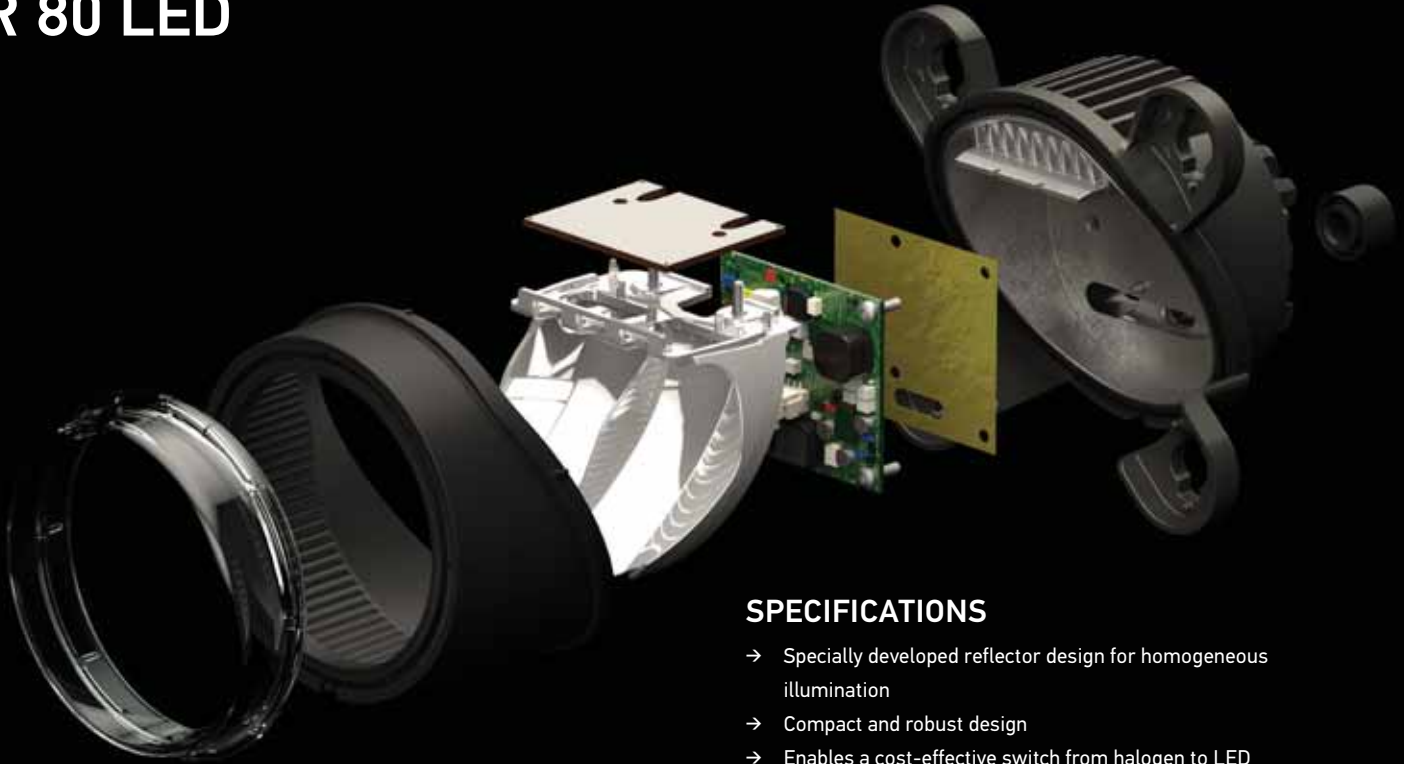

SPECIFICATIONS

- Specially developed reflector design for homogeneous illumination
- Compact and robust design
- Enables a cost-effective switch from halogen to LED
- Optional FEP or DEUTSCH connector

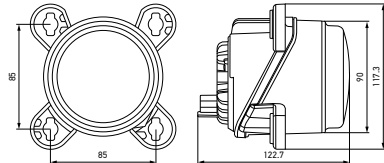
Product image / Dimensions	Features	Additional information	Part Number
R 80 LED HIGH BEAM LED 	LED <ul style="list-style-type: none"> • High beam headlight module • Polycarbonate lens • Plastic housing • Silver design cover • Black finish cover • Voltage: 9 - 32 VDC • Power consumption: 20 Watt • Integrated 4-pin DT connector • Approval: ECE / SAE • Protection: IP X9K, IP X4K, IP 5KX 	Mounting: • Recessed Applications: • Universal application • Headlight upgrade Contents: • 1 headlight, assembly instructions and installation components	015050001* ECE, connector DT
			015050011* ECE, connector DT
			015050031* SAE, connector DT
			015050151** SAE, connector DT
			015050101* ECE, connector FEP
			015050111* ECE, connector FEP
			015050131* SAE, connector FEP
* Mounting kit 25416300 not included in delivery. ** Mounting kit 25416300 included in delivery.			

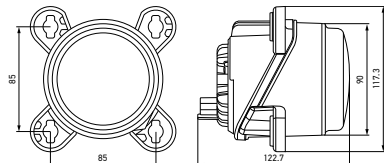
R 80 LED LOW BEAM LED 	LED <ul style="list-style-type: none"> • Low beam headlight module • Polycarbonate lens • Plastic shell • Silver design cover • Black finish cover • Voltage: 9 - 32 VDC • Power consumption: 20 Watt • Integrated 4-pin DT connector • Approval: ECE / SAE • Protection: IP X9K, IP X4K, IP 5KX 	Mounting: • Recessed Applications: • Universal application • Headlight upgrade Contents: • 1 headlight, assembly instructions and installation components	015050021* ECE, SAE, connector DT
			015050141** ECE, SAE, connector DT
			015050121** ECE, SAE, connector
			FEP

A SOPHISTICATED SOLUTION: the smart module selector

Find the right headlamp module in just a few clicks:

Our smart module selector will make your search easier. Simply use the filter to select the required criteria, such as the lighting function or homologation, and you will see suitable products right away.

www.hella.com/headlamp-modules



+ Simple menu structure and use

Our module selector is easy to use and makes it simple for original equipment manufacturers and end customers to find the right module – just like its predecessor, which has already proved its worth in practice. We have built on this and added further module types to the configurator.

+ Illumination comparison

Compare the lighting technology for selected main light functions: Spot the difference between halogen and LED with realistic images from Europe's largest light testing facility! Compare the light distribution and choose the one that suits your application.

+ Upgrade to modern LED technology

Existing halogen versions can be easily converted to LED modules. More detailed information is found in the assembly instructions supplied with the LED modules.

+ It is easy to order parts

Use the selector to easily create your order list and send it to HELLA.

+ Precise comparison

All key technical details for each module can be found in the detailed overview – including optional accessories!

CONVERSION HEADLAMPS

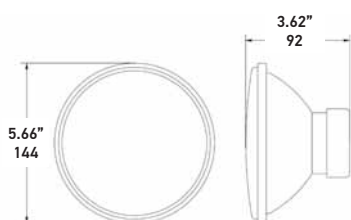

5 1/4" Sealed Beam Conversion Headlamps

Ideal For
Retrofitting
Replaces old sealed beam lighting technology

Features
Produces 50% more powerful beam on low beam
Produces 25% more powerful beam on high beam
Single lamp fits left or right
ECE versions for off-road use only in USA
Dust boots included

Part Number	Description
002850811	High/Low Beam (ECE), Kit, 2 H4 12 V 60/55W Bulbs, 2 Wiring Adapter Harnesses
002850871	High/Low Beam (ECE), 1 H4 12 V 60/55W Bulb, 1 Wiring Adapter Harness
002425811	High Beam (ECE), Kit, 2 H1 12 V 55W Bulbs, 4 Adapter Wires
002425901	High Beam (ECE), 1 H1 12 V 55W Bulb, 2 Adapter Wires

Product image /
Dimensions

Features

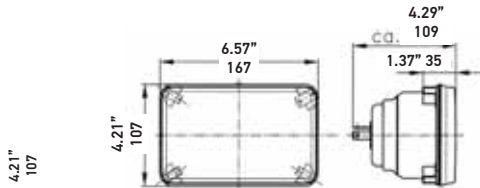

4" x 6" Rectangular Conversion Headlamps

Ideal For

 Retrofitting
Replaces old sealed beam lighting technology

Features

 Produces 50% more powerful beam on low beam
 Produces 25% more powerful beam on high beam
 Single lamp fits left or right
 ECE versions for off-road use only in USA
 Dust boots included

Part Number
003177801

High/Low Beam (ECE), Kit, 2 H4 12 V 60/55W Bulbs, 2 Wiring Adapter Harnesses

003177862

High/Low Beam (ECE), 1 H4 12 V 60/55W Bulb, 1 Wiring Adapter Harness

003177821

High Beam (ECE), Kit, 2 H1 12 V 55W Bulbs, 4 Adapter Wires

003177871

High Beam (ECE), 1 H1 12 V 55W Bulb, 2 Adapter Wires

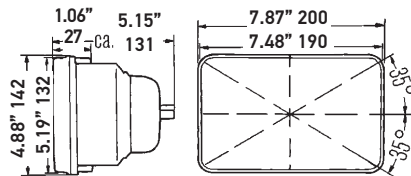

Vision Plus 6" x 7" Rectangular Conversion Headlamps

Ideal For

 Retrofitting
Replaces old sealed beam lighting technology

Features

 Based on European headlamp technology
 Brighter than a standard halogen due to improved optics without increased glare
 Produces 50% more powerful beam on low beam
 Produces 25% more powerful beam on high beam
 Single lamp fits left or right
 Replaces standard sealed beam 6052, 6053, H6052, H6054
 Direct fit – no modification
 Dust boots included
 ECE versions for off-road use only in the USA

Part Number
003427811 High/Low Beam (ECE), Kit, 2 H4 12 V 60/55W Bulbs

003427291 High/Low Beam (SAE/DOT), 1 HB2/9003 12 V 60/55W Bulb

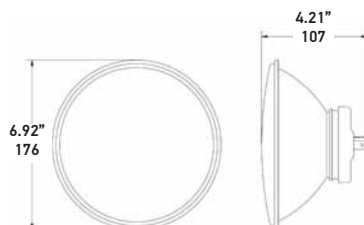
003427861 High/Low Beam (ECE), 1 H4 12 V 60/55W Bulb

Vision Plus 7" Round Conversion Headlamps

Ideal For

Retrofitting older sealed beam lamps to newer halogen replaceable bulbs

Features

 Based on European headlamp technology
 Brighter than a standard halogen due to improved optics without increased glare
 Produces 50% more powerful beam on low beam
 Produces 25% more powerful beam on high beam
 Single lamp fits left or right
 Replaces 6012, 6014, 6015, 6016, 6017, H6024, H6014, H6017, H6026
 Direct replacement for older sealed beam bulbs – no modifications
 Direct fit – no modification
 Dust boots included

Part Number
002395801 High/Low Beam (ECE), Kit, 2 H4 12 V 60/55W Bulbs

002395301 High/Low Beam (SAE/DOT), 1 HB2/9003 12 V 60/55W Bulb

002395991 High/Low Beam (ECE), 1 H4 12 V 60/55W Bulb



HELLA AUXILIARY LIGHTING

DIGITAL TOOLS

PRODUCT DETAILS

www.myhellalights.com

HELLA has adopted new communication technologies and provides a series of supporting information pages through the Internet. As a dynamic media, these pages are updated continuously and the websites grow online according to the needs of the customers.

Under www.myhellalights.com you will find photographs and 360° views of many of the products such as auxiliary lamps, as well as light bulbs, windshield wiper blades, speakers, the OPTILUX product range and much more.



www.myhellalights.com



ELIVER - Light simulations

Our online tool, Eliver, allows you to directly compare different lamps. All modules can be tested in a realistic 3D environment. Eliver also offers you the possibility to download the technical data sheets of the selected lamps.

All information, all lamps in just one click.

www.hella.com/MicroSite/eliver_US-Version



www.hella.com/MicroSite/eliver_US-Version



HELLA ADDLIGHT

**Search, select and virtually install auxiliary lamps
HELLA in your vehicle**

The new HELLA application allows you to virtually install your favorite auxiliary lights directly on a photo of your vehicle.

It is easy:

1. Install the application on your smartphone using the QR code.
2. Download the free HELLA application to your Smartphone or Tablet using the QR code of www.hella.com/apps or directly from iTunes and Google Play (Apple iOS or Android) and you're ready.



www.hella.com/apps



ORIGINAL PARTS

Functional safety, a perfect fit and product durability



NIGHTDRIVE - Learn the latest in lighting innovations with features in a 3D environment, available on Apple Store and Google Play

VEHICLES SPECIFIC LIGHTING

HELLA offers three guarantees with its wide range of lighting products for specific vehicles: better functionality, perfect fit and lasting customer satisfaction. All spare parts are manufactured to the same specifications and quality standards as the parts HELLA manufactures for its customers of original equipment worldwide. Through our technological innovations it allows us to continually develop our range of products such as lamps, taillights and interior lights.

HELLA is a world leader in automotive lighting technology and is a provider of many OE brands. HELLA has helped transform halogen lighting systems to xenon AFS and now to LED matrix systems that make lighting our exclusive technology.

UPDATED!

Find lighting parts for specific vehicles at:



<https://hella.mypartfinder.com/>



NEW!
LED BULBS



HELLA BULBS: In combination with the lamps, taillights and other lighting components, the bulbs play a key role in providing good road lighting and optimal visibility to the vehicle.

This means that they are a crucial safety factor. Enough reason to choose the best quality when selecting the right bulb. So trust HELLA: our products cover a wide range of applications, for example: passenger cars, commercial vehicles and agricultural vehicles. Always enjoy optimal visibility, with HELLA!



www.myhellalights.com

SHAPELINE

DESIGN YOUR LIGHT

www.hella.com/shapeline



Configuration examples

INDIVIDUAL LIGHTING SIGNATURE!

The variety and range of shapes and the various combination options paired with a technically optimized product design make the new Shapeline series a true innovation in vehicle lighting.

Whether the front, side or rear of a vehicle, whatever size or series, being it small or large. Shapeline offers a unique and, above all, consistent look using a customized configuration and arrangement of lamps. This allows us to meet the demands of vehicle manufacturers with lower numbers of manufactured vehicles. Along with innovative variety of shapes of Shapeline lamps provide you with nearly infinite design freedom.

Tech or Style: The HELLA Shapeline series provides design freedom for nearly any application and vehicle, achieves a consistent light signature for your vehicle at the same time.

Design your light – with HELLA Shapeline!

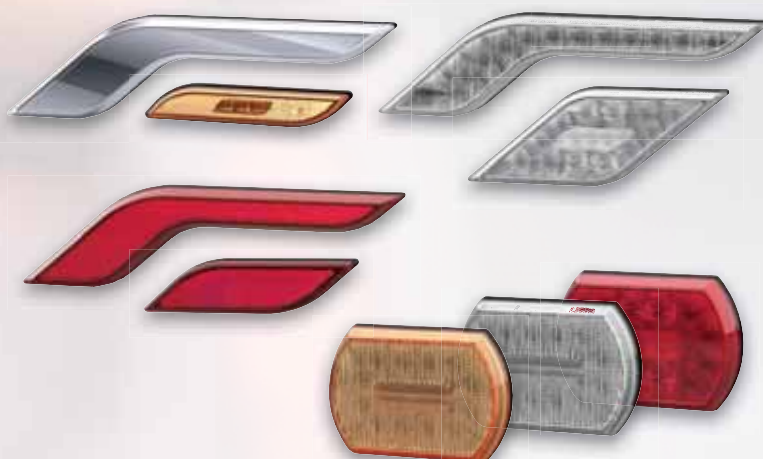

DESIGN WITH EASE

www.hella.com/shapeline

- Premium Design
- Customizable
- ECE and SAE
- Multivolt
- Robust
- Simple



HELLA *VALUEFIT*



HELLA VALUEFIT

Products for the toughest working conditions



HELLA VALUEFIT offers entry-level access to LED technology and represents a good solution for converting from halogen to LED. Compared to halogen work lights, LED work lights offer considerably better light output. The substantially higher color temperature of 6,000 Kelvin is very similar to natural daylight. This makes it easier to distinguish between different colors in the dark and, in turn, prevents the eyes from tiring quickly during work at night. VALUEFIT LED work lights are completely maintenance-free and offer a much longer service life than the bulb of a halogen headlamp.

HELLA products are measured in our inhouse state of the art light laboratory. HELLA is proud to be one of a few, who actually just advertise the **real measured lumen** for our light output. Be aware that a lot of competitors advertise their products with a theoretical raw or calculated light output, which can be far off the actual light output you get. With HELLA you can be sure, that the lights will meet your expectations and do provide the right amount of light for every application.



MICROSITE: Find more information about HELLA VALUEFIT work lights at:



www.hellahd.com





The products in this section can expose you to chemicals including Di(2-ethylhexyl) phthalate (DEHP), which is known to the State of California to cause cancer and birth defects or other reproductive harm. For more information go to [www. P65Warnings.ca.gov](http://www.P65Warnings.ca.gov)

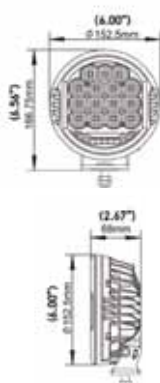

HELLA VALUEFIT AUXILIARY LIGHTS

Perfect replacement of your traditional Halogen Auxiliary lights. Equal in size and shape, but much higher light performance combined with a modern design and longer durability.

Product image / Dimensions	Features																						
<p>500 LED DRIVING LAMP</p>  <p>2100 lm</p>	<p>LED</p>  <p>Round LED Auxiliary light with high performance LEDs and stylish PO light. The 500 LED comes with a black stone shield cover. 2100 measured lumen and IP67 protection Off-road use only. Amber cover converts the 500 LED to a Fog lamp for dusty or foggy environments. Kit contains: (2) LED driving lights, stone shields, mounting brackets and hardware, (1) relay, switch and wiring harness</p> <table border="1"> <tr><td>Voltage</td><td>10-30 VDC</td></tr> <tr><td>Light pattern:</td><td>Driving Beam</td></tr> <tr><td>Light source:</td><td>LED</td></tr> <tr><td>Power consumption:</td><td>22.5 Watt</td></tr> <tr><td>Color temperature:</td><td>6000 Kelvin</td></tr> <tr><td>Housing material:</td><td>Aluminum</td></tr> <tr><td>Connection:</td><td>Wire leads (Single) / DT connector (Kit)</td></tr> <tr><td>Mounting:</td><td>Stainless steel bracket</td></tr> <tr><td>Dimensions:</td><td>6.0" x 6.6" x 2.7" / 153 x 167 x 68 mm (WxHxD)</td></tr> <tr><td>Approvals:</td><td>CE, ECE-R10, ECE-R112, IP67</td></tr> <tr><td>Part Number</td><td>358117161 Single 358117171 Kit 358116991 Amber stone shield</td></tr> </table>	Voltage	10-30 VDC	Light pattern:	Driving Beam	Light source:	LED	Power consumption:	22.5 Watt	Color temperature:	6000 Kelvin	Housing material:	Aluminum	Connection:	Wire leads (Single) / DT connector (Kit)	Mounting:	Stainless steel bracket	Dimensions:	6.0" x 6.6" x 2.7" / 153 x 167 x 68 mm (WxHxD)	Approvals:	CE, ECE-R10, ECE-R112, IP67	Part Number	358117161 Single 358117171 Kit 358116991 Amber stone shield
Voltage	10-30 VDC																						
Light pattern:	Driving Beam																						
Light source:	LED																						
Power consumption:	22.5 Watt																						
Color temperature:	6000 Kelvin																						
Housing material:	Aluminum																						
Connection:	Wire leads (Single) / DT connector (Kit)																						
Mounting:	Stainless steel bracket																						
Dimensions:	6.0" x 6.6" x 2.7" / 153 x 167 x 68 mm (WxHxD)																						
Approvals:	CE, ECE-R10, ECE-R112, IP67																						
Part Number	358117161 Single 358117171 Kit 358116991 Amber stone shield																						

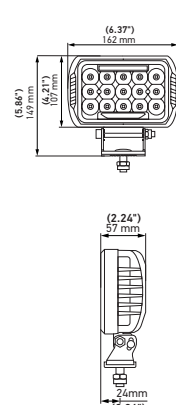
<p>450 LED DRIVING LAMP</p>  <p>3000 lm</p>	<p>LED</p>  <p>Rectangular LED Auxiliary light with high performance LEDs and stylish PO light. The 450 LED comes with a black stone shield cover. 3000 measured lumen and IP67 protection. Off-road use only. Kit contains: (2) LED driving lights, stone shields, mounting brackets and hardware, (1) relay, switch and wiring harness.</p> <table border="1"> <tr><td>Voltage</td><td>10-30 VDC</td></tr> <tr><td>Light pattern:</td><td>Driving Beam</td></tr> <tr><td>Light source:</td><td>LED</td></tr> <tr><td>Power consumption:</td><td>75 Watt</td></tr> <tr><td>Color temperature:</td><td>6000 Kelvin</td></tr> <tr><td>Housing material:</td><td>Aluminum</td></tr> <tr><td>Connection:</td><td>Wire leads</td></tr> <tr><td>Mounting:</td><td>Stainless steel bracket</td></tr> <tr><td>Dimensions:</td><td>6.4" x 5.9" x 2.2" / 162 x 149 x 57 mm (WxHxD)</td></tr> <tr><td>Approvals:</td><td>CE, ECE-R10, ECE-R112, IP67</td></tr> <tr><td>Part Number</td><td>358154041 Single 358154051 Kit 358154061 Amber stone shield</td></tr> </table>	Voltage	10-30 VDC	Light pattern:	Driving Beam	Light source:	LED	Power consumption:	75 Watt	Color temperature:	6000 Kelvin	Housing material:	Aluminum	Connection:	Wire leads	Mounting:	Stainless steel bracket	Dimensions:	6.4" x 5.9" x 2.2" / 162 x 149 x 57 mm (WxHxD)	Approvals:	CE, ECE-R10, ECE-R112, IP67	Part Number	358154041 Single 358154051 Kit 358154061 Amber stone shield
Voltage	10-30 VDC																						
Light pattern:	Driving Beam																						
Light source:	LED																						
Power consumption:	75 Watt																						
Color temperature:	6000 Kelvin																						
Housing material:	Aluminum																						
Connection:	Wire leads																						
Mounting:	Stainless steel bracket																						
Dimensions:	6.4" x 5.9" x 2.2" / 162 x 149 x 57 mm (WxHxD)																						
Approvals:	CE, ECE-R10, ECE-R112, IP67																						
Part Number	358154041 Single 358154051 Kit 358154061 Amber stone shield																						

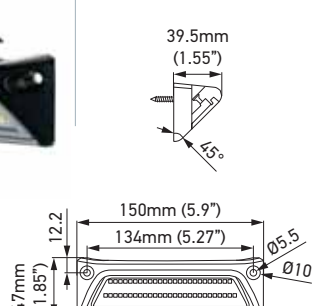
<p>SM2000</p> <p>NEW</p> 	<p>LED</p>  <p>The SMS2000 LED work lamp is recommended whenever effective uniform ground illumination by a vertically mounted work lamp is required. This function is particularly appreciated by campers, trucks, lorry drivers and service vehicles. With dual light function White: Work lamp / Amber: Ambient light Slender compact design. Perfect design for a wide range of applications. Homogeneous and wide-area light distribution</p> <table border="1"> <tr><td>Voltage</td><td>12 / 24 VDC</td></tr> <tr><td>Light pattern:</td><td>Extra wide illumination</td></tr> <tr><td>Light source:</td><td>LED</td></tr> <tr><td>Power consumption:</td><td>19 Watt (white)/ 10 W (white/amber)</td></tr> <tr><td>Color temperature:</td><td>6000 Kelvin</td></tr> <tr><td>Housing material:</td><td>Die-cast aluminium</td></tr> <tr><td>Connection:</td><td>Cable length: 500 mm, open cable ends</td></tr> <tr><td>Mounting:</td><td>Stainless steel bracket</td></tr> <tr><td>Dimensions:</td><td>5.9" x 1.85" x 1.55" / 150 x 47 x 39.5 mm (WxHxD)</td></tr> <tr><td>Approvals:</td><td>ECE-R10, UKCA, RCM, IP 6K9K, IP 6K8</td></tr> <tr><td>Part Number</td><td>357098001 Single light, white 357098011 Dual function white / amber (switchable)</td></tr> </table>	Voltage	12 / 24 VDC	Light pattern:	Extra wide illumination	Light source:	LED	Power consumption:	19 Watt (white)/ 10 W (white/amber)	Color temperature:	6000 Kelvin	Housing material:	Die-cast aluminium	Connection:	Cable length: 500 mm, open cable ends	Mounting:	Stainless steel bracket	Dimensions:	5.9" x 1.85" x 1.55" / 150 x 47 x 39.5 mm (WxHxD)	Approvals:	ECE-R10, UKCA, RCM, IP 6K9K, IP 6K8	Part Number	357098001 Single light, white 357098011 Dual function white / amber (switchable)
Voltage	12 / 24 VDC																						
Light pattern:	Extra wide illumination																						
Light source:	LED																						
Power consumption:	19 Watt (white)/ 10 W (white/amber)																						
Color temperature:	6000 Kelvin																						
Housing material:	Die-cast aluminium																						
Connection:	Cable length: 500 mm, open cable ends																						
Mounting:	Stainless steel bracket																						
Dimensions:	5.9" x 1.85" x 1.55" / 150 x 47 x 39.5 mm (WxHxD)																						
Approvals:	ECE-R10, UKCA, RCM, IP 6K9K, IP 6K8																						
Part Number	357098001 Single light, white 357098011 Dual function white / amber (switchable)																						

Product image / Dimensions	Features
----------------------------	----------

4LED CUBE

LED

600 lm

Flood Beam

690 lm

Spot Beam

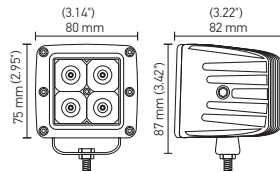

Compact LED cubes with great light distribution, both in flood and spot beam pattern. The wide 90 degree spread flood beams provide perfect light conditions around your vehicle. The far reaching spot beams provide additional light in front of your vehicle. 1 year warranty.

Kit contains: (2) LED lights, mounting brackets and hardware, (1) relay, switch and wiring harness with DT connector

Voltage:	10-30 VDC
Light pattern:	Spot Beam / Flood Beam
Light source:	LED
Power consumption:	12 Watt / 24 Watt (Kit)
Color temperature:	6000 Kelvin
Housing material:	Aluminum
Connection:	Wire leads (Single) / DT connector (Kit)
Mounting:	Stainless steel bracket
Dimensions:	3.1" x 3.4" x 3.2" / 80 x 75 x 82 mm (WxHxD)
Approvals:	IP67

Part Number

- 357204821** Kit, Spot Beam, Black housing
- 357204031** Flood Beam, Black housing
- 357204041** Flood Beam, White housing
- 357204831** Kit, Flood Beam, Black housing

6LED CUBE

LED

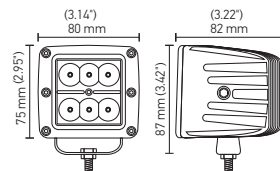
600 lm

The compact square design combined with 6 powerful LEDs are the perfect combination for you. Available as surface bracket mount or with a special flush mount cover to install it direct into the bumper. 1 year warranty

Voltage:	10-30 VDC
Light pattern:	Flood Beam
Light source:	LED
Power consumption:	18 Watt
Color temperature:	6000 Kelvin
Housing material:	Aluminum
Connection:	Wire leads
Mounting:	Stainless steel bracket
Dimensions:	3.1" x 3.4" x 3.2" / 80 x 75 x 82 mm (WxHxD)
Approvals:	IP67

Part Number

- 357204051** Flood Beam

6LED CUBE

LED

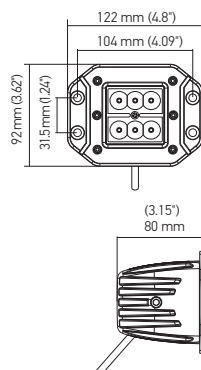



1000 lm

6LED Cube Flush Mount

The compact square design combined with 6 powerful LEDs are the perfect combination for you. Available as surface bracket mount or with a special flush mount cover to install it direct into the bumper. 1 year warranty

Voltage:	10-30 VDC
Light pattern:	Flood Beam
Light source:	LED
Power consumption:	18 Watt
Color temperature:	6000 Kelvin
Housing material:	Aluminum
Connection:	Wire leads
Mounting:	Stainless steel bracket
Dimensions:	4.8" x 3.6" x 3.1" / 122 x 92 x 80 mm (WxHxD)
Approvals:	IP67

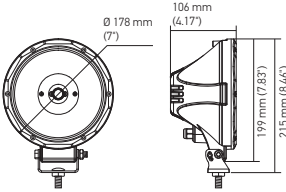
Part Number

- 357204021** Flood Beam

Product image / Dimensions	Features																				
<p>7" ROUND</p> <p>LED</p>  <p>1080 lm Driving Beam</p>  <p>3000 lm Spot Beam</p> 	<p>Classic 7" round Aux lights reflector design combined with modern LED technology. Powerful spot beam provides a bright and narrow light beam for good sight and safe maneuvering on and off the road. 1 year warranty</p> <table border="1"> <tr><td>Voltage</td><td>10-30 VDC</td></tr> <tr><td>Light pattern:</td><td>Driving Beam</td></tr> <tr><td>Light source:</td><td>LED</td></tr> <tr><td>Power consumption:</td><td>20 Watt</td></tr> <tr><td>Color temperature:</td><td>6000 Kelvin</td></tr> <tr><td>Housing material:</td><td>Aluminum</td></tr> <tr><td>Connection:</td><td>Wire leads</td></tr> <tr><td>Mounting:</td><td>Stainless steel bracket</td></tr> <tr><td>Dimensions:</td><td>7.0" x 8.5" x 4.2" / 178 x 178 x 106 mm (WxHxD)</td></tr> <tr><td>Approvals:</td><td>IP67 / SAE, ECE (Driving Beam)</td></tr> </table> <p>Part Number 35720001 Driving Beam 35720011 Spot Beam</p>	Voltage	10-30 VDC	Light pattern:	Driving Beam	Light source:	LED	Power consumption:	20 Watt	Color temperature:	6000 Kelvin	Housing material:	Aluminum	Connection:	Wire leads	Mounting:	Stainless steel bracket	Dimensions:	7.0" x 8.5" x 4.2" / 178 x 178 x 106 mm (WxHxD)	Approvals:	IP67 / SAE, ECE (Driving Beam)
Voltage	10-30 VDC																				
Light pattern:	Driving Beam																				
Light source:	LED																				
Power consumption:	20 Watt																				
Color temperature:	6000 Kelvin																				
Housing material:	Aluminum																				
Connection:	Wire leads																				
Mounting:	Stainless steel bracket																				
Dimensions:	7.0" x 8.5" x 4.2" / 178 x 178 x 106 mm (WxHxD)																				
Approvals:	IP67 / SAE, ECE (Driving Beam)																				

90MM SPOT LIGHT

LED

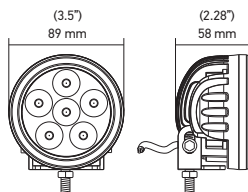
**1000 lm**

The compact round design combined with 6 powerful LEDs are the perfect combination for you. Available as surface bracket mount or with a special flush mount cover to install it direct into the bumper. 1 year warranty

Voltage	10-30 VDC
Light pattern:	Spot Beam
Light source:	LED
Power consumption:	18 Watt
Color temperature:	6000 Kelvin
Housing material:	Aluminum
Connection:	Wire leads
Mounting:	Stainless steel bracket
Dimensions	3.5" x 3.5" x 2.3" / 89 x 89 x 58 mm (WxHxD)
Approvals:	IP67
Part Number	357201001 Spot Beam

90MM SPOT LIGHT FLUSH MOUNT

LED

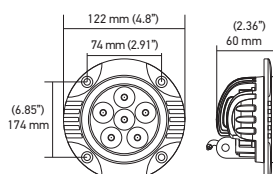
**1000 lm**

The compact round design combined with 6 powerful LEDs are the perfect combination for you. Available as surface bracket mount or with a special flush mount cover to install it direct into the bumper. 1 year warranty

Voltage	10-30 VDC
Light pattern:	Spot Beam
Light source:	LED
Power consumption:	18 Watt
Color temperature:	6000 Kelvin
Housing material:	Aluminum
Connection:	Wire leads
Mounting:	Stainless steel bracket
Dimensions	4.8" x 4.8" x 2.4" / 122 x 122 x 60 mm (WxHxD)
Approvals:	IP67
Part Number	357201011 Spot Beam

Product image / Dimensions	Features
----------------------------	----------

6LED MINN LIGHTBAR

LED



1000 lm

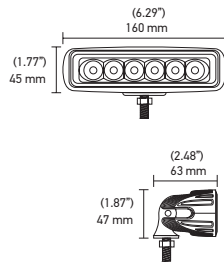

Thanks to its 6 high power LEDs, it is a top seller in this range. The low profile shape and the adjustable mounting bracket make this lamp a desired addition to any vehicle. 1 year warranty

Voltage	10-30 VDC
Light pattern:	Flood Beam
Light source:	LED
Power consumption:	18 Watt
Color temperature:	6000 Kelvin
Housing material:	Aluminum
Connection:	Wire leads
Mounting:	Stainless steel bracket
Dimensions	6.3" x 1.8" x 2.5" / 160 x 45 x 63 mm (WxHxD)
Approvals:	IP67
Part Number	357203001 Flood, Black housing 357203051 Flood, White housing

6LED MINI LIGHTBAR

LED



1000 lm

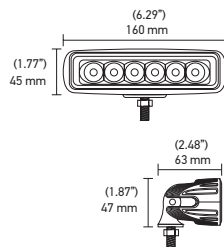

Thanks to its 6 high power LEDs, it is a top seller in this range. The low profile shape and the adjustable mounting bracket make this lamp a desired addition to any vehicle. 1 year warranty

Voltage	10-30 VDC
Light pattern:	Flood Beam
Light source:	LED
Power consumption:	18 Watt
Color temperature:	6000 Kelvin
Housing material:	Aluminum
Connection:	Wire leads
Mounting:	Stainless steel bracket
Dimensions	6.3" x 1.8" x 2.5" / 160 x 45 x 63 mm (WxHxD)
Approvals:	IP67
Part Number	357203011 Spot, Black housing

6LED MINI LIGHTBAR FLUSH MOUNT

LED



1000 lm

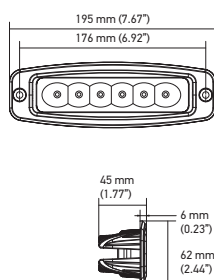

Thanks to its 6 high power LEDs, it is a top seller in this range. The low profile shape and the adjustable mounting bracket make this lamp a desired addition to any vehicle. The flush mount housing works perfect for the install direct into the bumper. 1 year warranty

Voltage	10-30 VDC
Light pattern:	Flood Beam
Light source:	LED
Power consumption:	18 Watt
Color temperature:	6000 Kelvin
Housing material:	Aluminum
Connection:	Wire leads
Mounting:	Stainless steel bracket
Dimensions	7.7" x 2.4" x 1.8" / 195 x 62 x 45 mm (WxHxD)
Approvals:	IP67
Part Number	357203031 Flood, Black Housing

Product image / Dimensions	Features
----------------------------	----------

HELLA VALUEFIT LBE 160

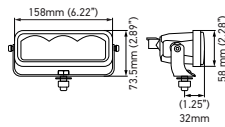
2000 lm

Innovative lens design for a stealthy look. The low mounting position offers exceptional surface illumination. Frameless design prevents dust deposits from settling on the edges 1 year warranty.

Voltage	10-48 VDC
Light pattern:	Driving beam
Light source:	LEDs
Energy consumption:	22 Watt
color temperature:	6500 Kelvin
Shell material:	Aluminum
Connection:	Integrated DT connector + 7ft (2000mm) adapter cable with open leads
Mounting:	stainless steel bracket
Dimensions:	6.22" x 2.89" x 2.28" / 158 x 74 x 72mm (WxHxD)
Approvals:	ECE R10, ECE R112, IP67
Part number	358154011 Driving beam

HELLA VALUEFIT LBE 320

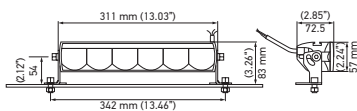
3500 lm
With LED Position Light

Innovative lens design for a stealthy look. The low mounting position offers exceptional surface illumination. Frameless design prevents dust deposits from settling on the edges 1 year warranty.

Voltage	10-48 VDC
Light pattern:	Driving beam
Light source:	LEDs
Energy consumption:	48 Watt
color temperature:	6500 Kelvin
Shell material:	Aluminum
Connection:	Integrated DT connector + 7ft (2000mm) adapter cable with open leads
Mounting:	stainless steel bracket
Dimensions	13.03" x 3.26" x 2.85" / 311 x 83 x 72mm (WxHxD)
Approvals:	ECE R10, ECE R112, IP67
Part number:	358154011 Driving beam

HELLA VALUEFIT LBE 480

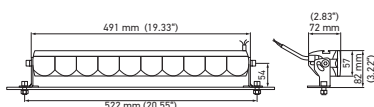
6200 lm
With LED Position Light

Innovative lens design for a stealthy look. The low mounting position offers exceptional surface illumination. Frameless design prevents dust deposits from settling on the edges 1 year warranty.

Voltage	10-48 VDC
Light pattern:	Long-range
Light source:	LEDs
Energy consumption:	53 Watt
color temperature:	6500 Kelvin
Shell material:	Aluminum
Connection:	Integrated DT connector + 7ft (2000mm) adapter cable with open leads
Mounting:	stainless steel bracket
Dimensions	19.33" x 3.22" x 2.85" / 491 x 83 x 72mm (WxHxD)
Approvals:	ECE R10, ECE R112, IP67
Part number:	358154021 Long Range

HELLA VALUEFIT LBX SERIES

- 1 Combo Beam.** A combination of a spot beam and flood beam for the LBX-540 & LBX-720
- 2 Diecast Aluminum Housing** able to withstand the elements.
- 3 Aluminum Alloy Brackets** for sturdy upright mounting. A perfect fit for roof, grille and bumper mounting.
- 4** An all around professional LED light bar, a perfect fit for your next race to out shine the competition!



Color Temperature

→ Color temperature is close to natural daylight.
Drivers operating in such lighting conditions stay alert longer.

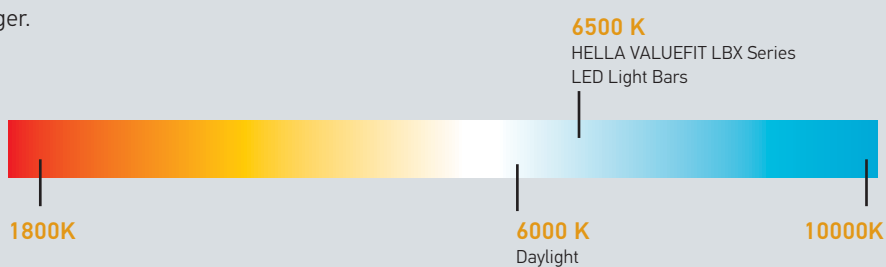

Product image / Dimensions	Features
----------------------------	----------

LBX 220 LED - 8"

8.2" (209 mm) 3.1" (80 mm)

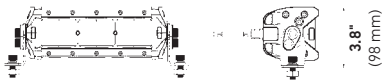
1000 lm

Innovative lens design for stealth look. Low mounting position offers exceptional ground illumination. 1 year warranty

Voltage	9-30 VDC
Light pattern:	Flood Beam
Light source:	LED
Power consumption:	22 Watt
Color temperature:	6500 Kelvin
Housing material:	Aluminum
Connection:	Integrated DT connector + 7ft (2000mm) adapter cable with open wires
Mounting:	Stainless steel bracket
Dimensions	8.2" x 3.8" x 3.1" / 209 x 98 x 80 mm (WxHxD)
Approvals:	CE, ECE-R10, IP67
Part Number	36000002 Close Range

LBX 380 LED - 14"

14" (374 mm) 3.1" (80 mm)

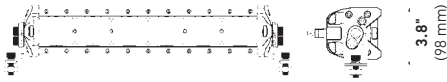
2000 lm

Innovative lens design for stealth look. Low mounting position offers exceptional ground illumination. 1 year warranty

Voltage	9-30 VDC
Light pattern:	Flood Beam
Light source:	LED
Power consumption:	44 Watt
Color temperature:	6500 Kelvin
Housing material:	Aluminum
Connection:	Integrated DT connector + 7ft (2000mm) adapter cable with open wires
Mounting:	Stainless steel bracket
Dimensions	14.0" x 3.8" x 3.1" / 374 x 98 x 80 mm (WxHxD)
Approvals:	CE, ECE-R10, IP67
Part Number	36001002 Combo Beam

LBX 540 LED - 21"

21" (539 mm) 3.1" (80 mm)

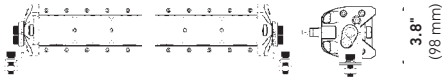
SAE APPROVED
3500 lm

Innovative lens design for stealth look. Low mounting position offers exceptional ground illumination. The combination of Flood and Spot reflectors creates a far and wide illumination for maximum visibility at night. 1 year warranty

Voltage	9-30 VDC
Light pattern:	Combo Beam
Light source:	LED
Power consumption:	66 Watt
Color temperature:	6500 Kelvin
Housing material:	Aluminum
Connection:	Integrated DT connector + 7ft (2000mm) adapter cable with open wires
Mounting:	Stainless steel bracket
Dimensions	21" x 3.8" x 3.1" / 539 x 98 x 80 mm (WxHxD)
Approvals:	CE, ECE-R10, ECE-R112, SAE approved, IP67
Part Number	36002002 Combo Beam

LBX 720 LED - 27"

27" (704 mm) 3.1" (80 mm)

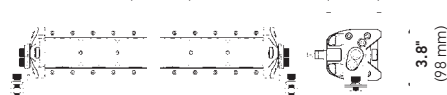
5500 lm

Innovative lens design for stealth look. Low mounting position offers exceptional ground illumination. The combination of Flood and Spot reflectors creates a far and wide illumination for maximum visibility at night. 1 year warranty

Voltage	9-30 VDC
Light pattern:	Combo Beam
Light source:	LED
Power consumption:	88 Watt
Color temperature:	6500 Kelvin
Housing material:	Aluminum
Connection:	Integrated DT connector + 7ft (2000mm) adapter cable with open wires
Mounting:	Stainless steel bracket
Dimensions	27" x 3.8" x 3.1" / 704 x 98 x 80 mm (WxHxD)
Approvals:	CE, ECE-R10, ECE-R112, IP67
Part Number	36003002

HELLA VALUEFIT SPORT SERIES

- 1 Combo Beam.** A combination of a spot beam and flood beam.
- 2 Diecast Aluminum Housing** able to withstand the elements.
- 3 Aluminum Alloy Brackets** for sturdy upright mounting. A perfect fit for roof, grille and bumper mounting.
- 4** Get that off-road look whether you're on the street or blazing the trails!



Color Temperature

→ Color temperature is close to natural daylight.
Drivers operating in such lighting conditions
stay alert longer.

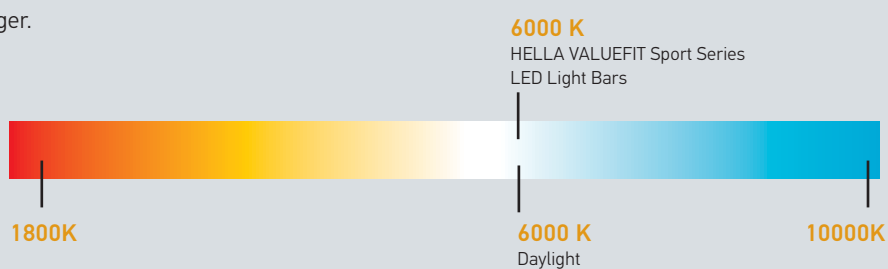

Product image / Dimensions	Features
----------------------------	----------

12 LED SPORT SERIES - 8"

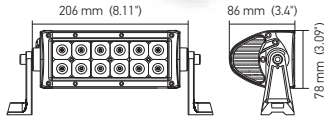
1200 lm

The double row reflector gives this SPORT SERIES its modern look and great light performance. 1 year warranty

Voltage	10-30 VDC
Light pattern:	Flood Beam
Light source:	LED
Power consumption:	36 Watt
Color temperature:	6000 Kelvin
Housing material:	Aluminum
Connection:	Wire leads
Mounting:	Stainless steel bracket
Dimensions	8.1" x 3.0" x 3.4" / 206 x 78 x 86 mm (WxHxD)
Approvals:	IP67
Part Number	357208001 Black housing 357208011 White housing

40 LED SPORT SERIES - 22"

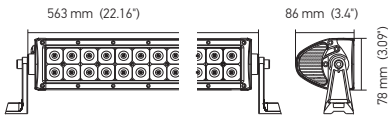
4300 lm

The double row reflector gives this SPORT SERIES its modern look and great light performance. The combination of Flood and Spot reflectors creates a far and wide illumination for maximum visibility at night. 1 year warranty

Voltage	10-30 VDC
Light pattern:	Combo Beam
Light source:	LED
Power consumption:	120 Watt
Color temperature:	6000 Kelvin
Housing material:	Aluminum
Connection:	Wire leads
Mounting:	Stainless steel bracket
Dimensions	22.1" x 3.1" x 3.4" / 558 x 78 x 86 mm (WxHxD)
Approvals:	IP67
Part Number	357208101 Combo beam

Product image / Dimensions	Features
----------------------------	----------

6 LED DESIGN SERIES - 11"

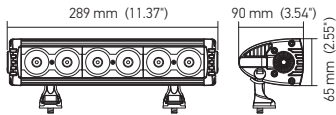
3000 lm

The round reflectors give the DESIGN SERIES the unique appearance. The combination of Flood and Spot reflectors creates a far and wide illumination for maximum visibility at night. 1 year warranty

Voltage	10-30 VDC
Light pattern:	Combo Beam
Light source:	LED
Power consumption:	60 Watt
Color temperature:	6000 Kelvin
Housing material:	Aluminum
Connection:	Wire leads
Mounting:	Stainless steel bracket
Dimensions	11.4" x 2.6" x 3.5" / 289 x 65 x 90 mm (WxHxD)
Approvals:	IP67
Part Number	357209001 Combo beam

12 LED DESIGN SERIES - 21"

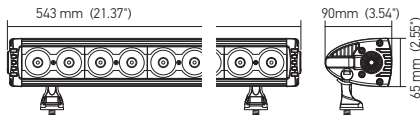
5500 lm

The round reflectors give the DESIGN SERIES the unique appearance. The combination of Flood and Spot reflectors creates a far and wide illumination for maximum visibility at night. 1 year warranty

Voltage	10-30 VDC
Light pattern:	Combo Beam
Light source:	LED
Power consumption:	180 Watt
Color temperature:	6000 Kelvin
Housing material:	Aluminum
Connection:	Wire leads
Mounting:	Stainless steel bracket
Dimensions	21.4" x 2.6" x 3.5" / 543 x 65 x 90 mm (WxHxD)
Approvals:	IP67
Part Number	357209101

18 LED DESIGN SERIES - 31"

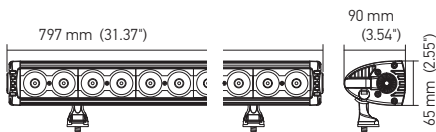
8500 lm

The round reflectors give the DESIGN SERIES the unique appearance. The combination of Flood and Spot reflectors creates a far and wide illumination for maximum visibility at night. 1 year warranty

Voltage	10-30 VDC
Light pattern:	Combo Beam
Light source:	LED
Power consumption:	180 Watt
Color temperature:	6000 Kelvin
Housing material:	Aluminum
Connection:	Wire leads
Mounting:	Stainless steel bracket
Dimensions	31.4" x 2.6" x 3.5" / 797 x 65 x 90 mm (WxHxD)
Approvals:	IP67
Part Number	357209201

30 LED DESIGN SERIES - 51"

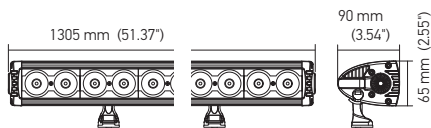
14500 lm

The round reflectors give the DESIGN SERIES the unique appearance. The combination of Flood and Spot reflectors creates a far and wide illumination for maximum visibility at night. 1 year warranty

Voltage	10-30 VDC
Light pattern:	Combo Beam
Light source:	LED
Power consumption:	300 Watt
Color temperature:	6000 Kelvin
Housing material:	Aluminum
Connection:	Wire leads
Mounting:	Stainless steel bracket
Dimensions	51.4" x 2.6" x 3.5" / 1305 x 65 x 90 mm (WxHxD)
Approvals:	IP67
Part Number	357209301

Product image / Dimensions	Features
----------------------------	----------

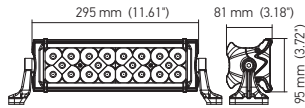
20 LED PRO SERIES - 12"

3100 lm

The powerful PRO SERIES comes with a double row reflector and state-of-the-art LED technology. Powerful LEDs provide perfect visibility at night. 1 year warranty

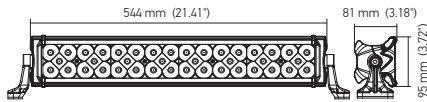
Voltage	10-30 VDC
Light pattern:	Spot Beam
Light source:	LED
Power consumption:	60 Watt
Color temperature:	5500 Kelvin
Housing material:	Aluminum
Connection:	Wire leads
Mounting:	Stainless steel bracket
Dimensions	11.6" x 3.7" x 3.2" / 285 x 96 x 81 mm (WxHxD)
Approvals:	IP67
Part Number	357210001

40 LED PRO SERIES - 21"

5500 lm

The powerful PRO SERIES comes with a double row reflector and state-of-the-art LED technology. The combination of Flood and Spot reflectors creates a far and wide illumination for maximum visibility at night. 1 year warranty







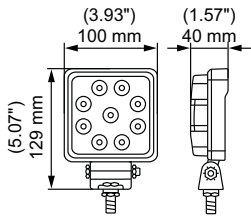

Voltage	10-30 VDC
Light pattern:	Combo Beam
Light source:	LED
Power consumption:	120 Watt
Color temperature:	5500 Kelvin
Housing material:	Aluminum
Connection:	Wire leads
Mounting:	Stainless steel bracket
Dimensions	21.4" x 3.7" x 3.2" / 544 x 96 x 81 mm (WxHxD)
Approvals:	IP67
Part Number	357210101

HELLA VALUEFIT WORKLIGHTS

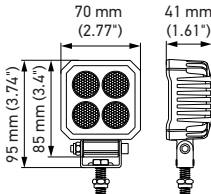
3rd Generation

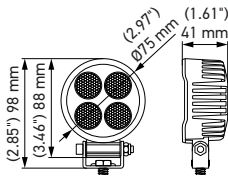
Check out our new high performance worklights with unique features, innovative technology and very powerful light output.

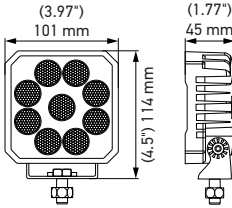

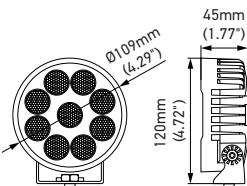
Product image / Dimensions	Features																		
<p>PS1000 LED</p>  <p>1000 lm</p>	<p style="text-align: center;">LED</p> <p>Latest LED technology. Thin plastic housing for 100% corrosion resistance. Lightweight - high vibration resistance. Black stainless steel mounting hardware. 2 year warranty.</p>  <table border="1"> <tr><td>Voltage</td><td>10 – 30 VDC</td></tr> <tr><td>Light output (measured):</td><td>1,000 Lumen</td></tr> <tr><td>Power consumption:</td><td>9 Watt</td></tr> <tr><td>Color temperature:</td><td>6,500 Kelvin</td></tr> <tr><td>Housing material:</td><td>Thermoplastic</td></tr> <tr><td>Connection:</td><td>30" (800mm) cable with open wires</td></tr> <tr><td>Mounting:</td><td>Black stainless steel bracket</td></tr> <tr><td>Approvals:</td><td>CE, ECE-R10, IP67, IP6K9K (withstands high pressure cleaning)</td></tr> <tr><td>Part Number</td><td>357114002 Close Range</td></tr> </table>	Voltage	10 – 30 VDC	Light output (measured):	1,000 Lumen	Power consumption:	9 Watt	Color temperature:	6,500 Kelvin	Housing material:	Thermoplastic	Connection:	30" (800mm) cable with open wires	Mounting:	Black stainless steel bracket	Approvals:	CE, ECE-R10, IP67, IP6K9K (withstands high pressure cleaning)	Part Number	357114002 Close Range
Voltage	10 – 30 VDC																		
Light output (measured):	1,000 Lumen																		
Power consumption:	9 Watt																		
Color temperature:	6,500 Kelvin																		
Housing material:	Thermoplastic																		
Connection:	30" (800mm) cable with open wires																		
Mounting:	Black stainless steel bracket																		
Approvals:	CE, ECE-R10, IP67, IP6K9K (withstands high pressure cleaning)																		
Part Number	357114002 Close Range																		
<p>TS1700 LED</p>  <p>1700 lm</p>	<p style="text-align: center;">LED</p> <p>Most powerful LED worklight in this size. Active Thermo Management to prevent overheating and ensures a long lifetime. Under cold working conditions the light output increases for an even better performance. Super compact size - just 3x3". Black stainless steel mounting hardware. 2 year warranty.</p>  <table border="1"> <tr><td>Voltage</td><td>10 – 30 VDC</td></tr> <tr><td>Light output (measured):</td><td>1,700 Lumen</td></tr> <tr><td>Power consumption:</td><td>24 Watt</td></tr> <tr><td>Color temperature:</td><td>5,700 Kelvin</td></tr> <tr><td>Housing material:</td><td>Aluminum</td></tr> <tr><td>Connection:</td><td>30" (800mm) cable with open wires</td></tr> <tr><td>Mounting:</td><td>Black stainless steel bracket</td></tr> <tr><td>Approvals:</td><td>CE, ECE-R10, IP67, IP6K9K (withstands high pressure cleaning)</td></tr> <tr><td>Part Number</td><td>357110002 Close Range</td></tr> </table>	Voltage	10 – 30 VDC	Light output (measured):	1,700 Lumen	Power consumption:	24 Watt	Color temperature:	5,700 Kelvin	Housing material:	Aluminum	Connection:	30" (800mm) cable with open wires	Mounting:	Black stainless steel bracket	Approvals:	CE, ECE-R10, IP67, IP6K9K (withstands high pressure cleaning)	Part Number	357110002 Close Range
Voltage	10 – 30 VDC																		
Light output (measured):	1,700 Lumen																		
Power consumption:	24 Watt																		
Color temperature:	5,700 Kelvin																		
Housing material:	Aluminum																		
Connection:	30" (800mm) cable with open wires																		
Mounting:	Black stainless steel bracket																		
Approvals:	CE, ECE-R10, IP67, IP6K9K (withstands high pressure cleaning)																		
Part Number	357110002 Close Range																		
<p>TR1700 LED</p>  <p>1700 lm</p>	<p style="text-align: center;">LED</p> <p>Most powerful LED worklight in this size. Active Thermo Management to prevent overheating and ensures a long lifetime. Under cold working conditions the light output increases for an even better performance. Super compact size - just 3x3". Black stainless steel mounting hardware. 2 year warranty.</p>  <table border="1"> <tr><td>Voltage</td><td>10 – 30 VDC</td></tr> <tr><td>Light output (measured):</td><td>1,700 Lumen</td></tr> <tr><td>Power consumption:</td><td>24 Watt</td></tr> <tr><td>Color temperature:</td><td>5,700 Kelvin</td></tr> <tr><td>Housing material:</td><td>Aluminum</td></tr> <tr><td>Connection:</td><td>30" (800mm) cable with open wires</td></tr> <tr><td>Mounting:</td><td>Black stainless steel bracket</td></tr> <tr><td>Approvals:</td><td>CE, ECE-R10, IP67, IP6K9K (withstands high pressure cleaning)</td></tr> <tr><td>Part Number</td><td>357111002 Close Range</td></tr> </table>	Voltage	10 – 30 VDC	Light output (measured):	1,700 Lumen	Power consumption:	24 Watt	Color temperature:	5,700 Kelvin	Housing material:	Aluminum	Connection:	30" (800mm) cable with open wires	Mounting:	Black stainless steel bracket	Approvals:	CE, ECE-R10, IP67, IP6K9K (withstands high pressure cleaning)	Part Number	357111002 Close Range
Voltage	10 – 30 VDC																		
Light output (measured):	1,700 Lumen																		
Power consumption:	24 Watt																		
Color temperature:	5,700 Kelvin																		
Housing material:	Aluminum																		
Connection:	30" (800mm) cable with open wires																		
Mounting:	Black stainless steel bracket																		
Approvals:	CE, ECE-R10, IP67, IP6K9K (withstands high pressure cleaning)																		
Part Number	357111002 Close Range																		
<p>TS3000 LED</p>  <p>3000 lm</p>	<p style="text-align: center;">LED</p> <p>Most powerful HELLA ValueFit worklight. Active Thermo Management to prevent overheating. Under cold working conditions the light output increases for an even better performance (up to 4,000 lm). Heavy Duty bracket for high impact resistance. Black stainless steel mounting hardware. 2 year warranty.</p>  <table border="1"> <tr><td>Voltage</td><td>10 – 30 VDC</td></tr> <tr><td>Light output (measured):</td><td>3,000 Lumen</td></tr> <tr><td>Power consumption:</td><td>31 Watt</td></tr> <tr><td>Color temperature:</td><td>5,700 Kelvin</td></tr> <tr><td>Housing material:</td><td>Aluminum</td></tr> <tr><td>Connection:</td><td>30" (800mm) cable with open wires</td></tr> <tr><td>Mounting:</td><td>Black stainless steel bracket</td></tr> <tr><td>Approvals:</td><td>CE, ECE-R10, IP67, IP6K9K (withstands high pressure cleaning)</td></tr> <tr><td>Part Number</td><td>357112002 Close Range</td></tr> </table>	Voltage	10 – 30 VDC	Light output (measured):	3,000 Lumen	Power consumption:	31 Watt	Color temperature:	5,700 Kelvin	Housing material:	Aluminum	Connection:	30" (800mm) cable with open wires	Mounting:	Black stainless steel bracket	Approvals:	CE, ECE-R10, IP67, IP6K9K (withstands high pressure cleaning)	Part Number	357112002 Close Range
Voltage	10 – 30 VDC																		
Light output (measured):	3,000 Lumen																		
Power consumption:	31 Watt																		
Color temperature:	5,700 Kelvin																		
Housing material:	Aluminum																		
Connection:	30" (800mm) cable with open wires																		
Mounting:	Black stainless steel bracket																		
Approvals:	CE, ECE-R10, IP67, IP6K9K (withstands high pressure cleaning)																		
Part Number	357112002 Close Range																		
<p>TR3000 LED</p>  <p>3000 lm</p>	<p style="text-align: center;">LED</p> <p>Most powerful HELLA ValueFit worklight. Active Thermo Management to prevent overheating. Under cold working conditions the light output increases for an even better performance (up to 4,000 lm). Heavy Duty bracket for high impact resistance. Black stainless steel mounting hardware. 2 year warranty.</p>  <table border="1"> <tr><td>Voltage</td><td>10 – 30 VDC</td></tr> <tr><td>Light output (measured):</td><td>3,000 Lumen</td></tr> <tr><td>Power consumption:</td><td>31 Watt</td></tr> <tr><td>Color temperature:</td><td>5,700 Kelvin</td></tr> <tr><td>Housing material:</td><td>Aluminum with black stainless steel mounting bracket</td></tr> <tr><td>Connection:</td><td>30" (800mm) cable with open wire leads</td></tr> <tr><td>Approvals:</td><td>CE, ECE-R10, IP67, IP6K9K (withstands high pressure cleaning)</td></tr> <tr><td>Part Number</td><td>357113002 Close Range</td></tr> </table>	Voltage	10 – 30 VDC	Light output (measured):	3,000 Lumen	Power consumption:	31 Watt	Color temperature:	5,700 Kelvin	Housing material:	Aluminum with black stainless steel mounting bracket	Connection:	30" (800mm) cable with open wire leads	Approvals:	CE, ECE-R10, IP67, IP6K9K (withstands high pressure cleaning)	Part Number	357113002 Close Range		
Voltage	10 – 30 VDC																		
Light output (measured):	3,000 Lumen																		
Power consumption:	31 Watt																		
Color temperature:	5,700 Kelvin																		
Housing material:	Aluminum with black stainless steel mounting bracket																		
Connection:	30" (800mm) cable with open wire leads																		
Approvals:	CE, ECE-R10, IP67, IP6K9K (withstands high pressure cleaning)																		
Part Number	357113002 Close Range																		



Product image / Dimensions	Features
----------------------------	----------

S3000 LED

LED



3000 lm

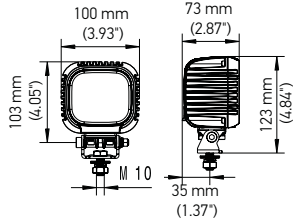

Perfect close range illumination to generate daylight working conditions at night. Designed for applications at the highest lighting requirements. Powerful compact LED worklight - 1 light can replace up to 3 halogen worklights. Integrated DT connector for safe and perfectly sealed electrical connection. 2 year warranty.

Voltage	10 – 52 VDC
Light output (measured):	3,000 Lumen
Power consumption:	31 Watt
Color temperature:	6000 Kelvin / 2500 Kelvin amber version
Housing material:	Aluminum
Connection:	Integrated DT Connector + 30" (800mm) adapter cable with open wire leads
Mounting:	Stainless steel bracket
Approvals:	CE, ECE-R10, RoHS, IP67, IP6K9K (withstands high pressure cleaning)
Part Number	357109002 Close Range 357109022 Close Range, amber

MASTER 1400 LED

NEW

LED



1350 lm

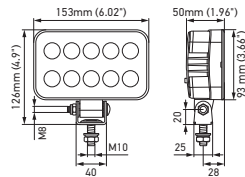

The new technological generation of the popular, rectangular master work lamp series for converting to LED with corrosion-free plastic housing in slim design without edges. Available in two different bracket versions. Straight-forward and convenient mounting thanks to square hole in bracket. Robust and vibration-reducing mounting. Integrated DT connector for safe and perfectly sealed electrical connection. 2 year warranty.

Voltage	12 VDC / 24 VDC
Light output (measured):	1,350 Lumen
Power consumption:	18 Watt
Color temperature:	6500 Kelvin
Housing material:	Corrosion-free plastic housing
Connection:	500 mm cable with open end
Mounting:	Stainless steel bracket
Approvals:	ECE-R10, UKCA, ADR / GGVSEB, IP 6K7, IP 6K9K (withstands high pressure cleaning)
Part Number	357877001 Close Range, with short mounting bracket

5RD LED 2.0

LED



2000 lm

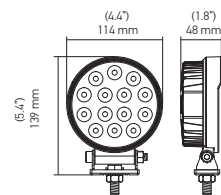

Powerful LED worklight. Flat and compact design. Also available in amber for winter or foggy environments. Stainless steel mounting hardware. 1 year warranty.

Voltage	10 - 30 VDC
Light output (measured):	2000 Lumen / 1700 Lumen amber version
Power consumption:	24 Watt
Color temperature:	6000 Kelvin / 2500 Kelvin amber version
Housing material:	Aluminum
Connection:	20" (500mm) cable with open wires
Mounting:	Stainless steel bracket
Approvals:	CE, ECE-R10, IP67, IP6K9K (withstands high pressure cleaning)
Part Number	357105002 Close Range 357105012 Long Range 358115371 (357106012AMB) Close Range, amber

5RD LED 1.0

LED



1000 lm

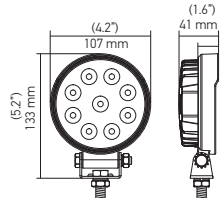

Favorite LED worklight in size and shape. Flat and round design (4" diameter). Stainless steel mounting hardware. 1 year warranty.

Voltage	10 - 30 VDC
Light output (measured):	1000 Lumen
Power consumption:	15 Watt
Color temperature:	6000 Kelvin
Housing material:	Aluminum
Connection:	20" (500mm) cable with open wires
Mounting:	Stainless steel bracket
Approvals:	CE, ECE-R10, IP67, IP6K9K (withstands high pressure cleaning)
Part Number	357101002 Close Range 357100002 Long Range

Product image / Dimensions	Features
----------------------------	----------

5RD LED

LED



700 lm

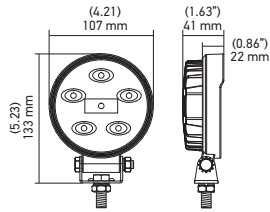

Perfect entry level worklight for a switch from halogen to LED. Flat and square design (4x4), Stainless steel mounting hardware. 1 year warranty.

Voltage	10 - 30 VDC
Light output (measured):	700 Lumen
Power consumption:	9 Watt
Color temperature:	6000 Kelvin
Housing material:	Aluminum
Connection:	20" (500mm) cable with open wires
Mounting:	Stainless steel bracket
Approvals:	CE, ECE-R10, IP67, IP6K9K (withstands high pressure cleaning)
Part Number	357108001 Close Range

4SQ LED 2.0

LED



2000 lm

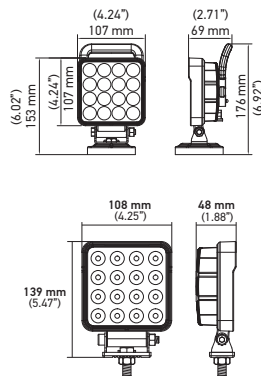

Powerful LED worklight in suitable size. Also available with a magnet, switch and handle. Stainless steel mounting hardware. 1 year warranty.

Voltage	10 - 30 VDC
Light output (measured):	2000 Lumen
Power consumption:	24 Watt
Color temperature:	6000 Kelvin
Housing material:	Aluminum
Connection:	20" (500mm) cable with open wires
Mounting:	Stainless steel bracket
Approvals:	CE, ECE-R10, IP67, IP6K9K (withstands high pressure cleaning)
Part Number	357106002 Close Range 357106012 Long Range 357103061 Close Range, Handle + Switch, Magnet

4SQ LED 1.0

LED



1000 lm

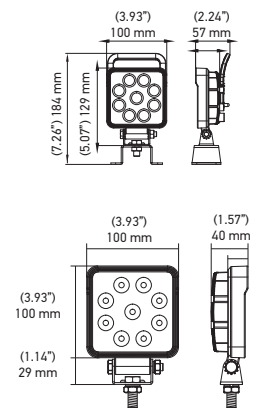

Favorite LED worklight in size and shape. Flat and square design (4x4). Also available with a handle and switch. Stainless steel mounting hardware. 1 year warranty.

Voltage	10 - 30 VDC
Light output (measured):	1000 Lumen
Power consumption:	15 Watt
Color temperature:	6000 Kelvin
Housing material:	Aluminum
Connection:	20" (500mm) cable with open wires
Mounting:	Stainless steel bracket
Approvals:	CE, ECE-R10, IP67, IP6K9K (withstands high pressure cleaning)
Part Number	357103002 Close Range 357102002 Long Range 357103041 Close Range, Handle + Switch, DT connector 357103051 Long Range, Handle + Switch, DT connector

4SQ LED

LED



700 lm

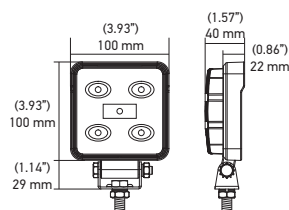

Perfect entry level worklight for a switch from halogen to LED. Flat and square design (4x4). Stainless steel mounting hardware. 1 year warranty.

Voltage	10 - 30 VDC
Light output (measured):	700 Lumen
Power consumption:	9 Watt
Color temperature:	6000 Kelvin
Housing material:	Aluminum
Connection:	20" (500mm) cable with open wires
Mounting:	Stainless steel bracket
Approvals:	CE, ECE-R10, IP67, IP6K9K (withstands high pressure cleaning)
Part Number	357107001 Close Range



Product image / Dimensions	Features
----------------------------	----------

RC 360 GEN. 2

LED



3250 lm

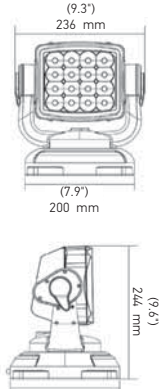

Remote controlled LED searchlight
 Vertical rotation: 110 degree, horizontal rotation: 360 degree
 Flash function: SOS Distress Signal (3 long flash - 2 short flash)
 Remote control and batteries included
 1 year warranty

Voltage	10 - 30 VDC
Light output (measured):	3250 Lumen
Power consumption:	80 Watt
Color temperature:	6500 Kelvin
Housing material:	Aluminum
Connection:	15 ft cable with cigarette lighter plug
Mounting:	Magnet or fixed mounting (upright only)
Approvals:	IP67

Part Number	357104041 Spot light, Black housing
	357104051 Spot light, White housing

2 LED BLUE

LED



300 lm



Great optical warning effect to increase work safety. Provides visual blue warning signal for pedestrians. 2 LEDs project the blue light beam spot within 3-5 meters in front of the vehicle. Designed for forklifts. 1 year warranty.

Voltage	10 - 80 VDC
Light output (measured):	300 Lumen
Power consumption:	6 Watt
Color temperature:	9000 Kelvin
Housing material:	Aluminum
Connection:	20" (500mm) cable with open wires
Mounting:	Stainless steel bracket
Approvals:	CE, ECE-R10, IP67, IP6K9K (withstands high pressure cleaning)

Part Number	530040329 (H71030181) Warning Spot, Blue
--------------------	---

SL60 LED

LED



- Super compact LED warning stripe to improve the safety at work
- Projection: Blue or red stripe-shaped warning line to the ground
- Powerful light output for visibility even under daylight conditions
- Compact design is well-suited when little installation space is available
- 2 year warranty

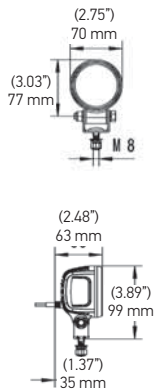

- Voltage: 10-80 VDC
- Power Consumption: max. 7 Watt
- Colors: Blue, Red
- Housing Material: Aluminum
- Connection: 20" cable with open wires
- Mounting: Stainless Steel Bracket
- Approvals: CE, ECE-R10, IP6K9K (withstands high pressure cleaning)

996210001 Blue

996210011 Red

- Contains:**
- 1 LED Light
 - Mounting instructions and installation components



Product image / Dimensions	Features
----------------------------	----------

WIRE HARNESS FOR SINGLE LIGHT



Perfect for HELLA ValueFit auxiliary lights and lightbars
For single light - up to 300W of power
Relay, switch and fuse included

Voltage:	12 VDC
Power:	Up to 300 W
Connection:	ATP Connector
Contains:	1 x 10 ft cable, 1 x 18" fuse cable, 1 x 6.4 ft switch cable
Part Number	357211001

WIRE HARNESS FOR TWO LIGHTS



Wire Harness for Two Lights

Perfect for HELLA ValueFit auxiliary lights and lightbars
For two lights - up to 300 W of power
Relay, switch and fuse included

Voltage:	12 VDC
Power:	Up to 300 W
Connection:	DT Connectors
Contains:	2 x 10 ft cable, 1 x 18" fuse cable, 1 x 6.4 ft switch cable
Part Number	357211011

DISPLAYS:

Product displays are the number one sales tool to highlight new products and get the immediate attention of the customers. Having a well designed product displays helps to explain the products and will have a positive effect on the sales success. Our displays are fully assembled, completely wired, using high quality On/Off switches and a 110 V power supply.

HELLA VALUEFIT AUXILIARY LIGHT DISPLAY



Products	(1) HELLA VALUEFIT 450 LED (1) HELLA VALUEFIT 500 LED and amber stone shield
Dimensions	20" x 4" x 5.9" / 510 x 102 x 150 mm (WxHxD)
Part Number	358117201

HELLA VALUEFIT WORKLIGHT DISPLAY



Content	(1) HELLA VALUEFIT PS1000 (1) HELLA VALUEFIT TR1700 (1) HELLA VALUEFIT TS3000
Dimensions	17.7" x 4.7" x 6.3" / 450 x 120 x 160 mm (WxHxD)
N° de Parte	999942107

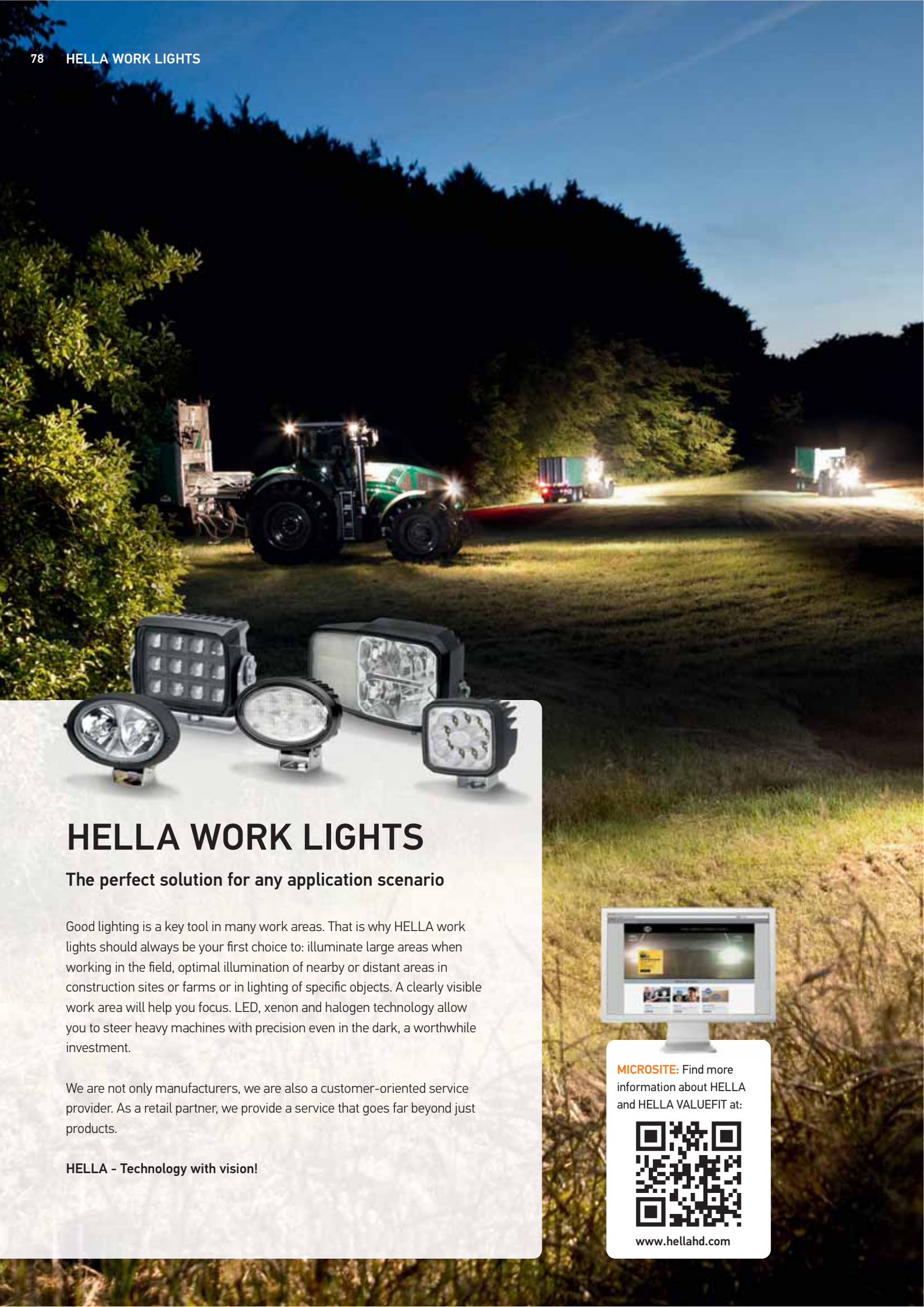

HELLA WORK LIGHTS

The perfect solution for any application scenario

Good lighting is a key tool in many work areas. That is why HELLA work lights should always be your first choice to: illuminate large areas when working in the field, optimal illumination of nearby or distant areas in construction sites or farms or in lighting of specific objects. A clearly visible work area will help you focus. LED, xenon and halogen technology allow you to steer heavy machines with precision even in the dark, a worthwhile investment.

We are not only manufacturers, we are also a customer-oriented service provider. As a retail partner, we provide a service that goes far beyond just products.

HELLA - Technology with vision!



MICROSITE: Find more information about HELLA and HELLA VALUEFIT at:



www.hellahd.com



HELLA solutions for more safety and comfort in your everyday working life

Vehicle lighting plays an important role in safety and workplace convenience. There are many situations where there is still room for improvement, especially when it comes to occupational safety. For example, it is important that hazard zones can be optically marked or demarcated at any time so that everyone in the affected area can be warned and protected in good time. Previously, this had to be done by the driver or by other workers, who would manually mark off the areas concerned. This meant that it was not possible to demarcate individual areas as required in a simple, swift and safe action. With the VISIOTECH projection technology, HELLA has brought products onto the market that are designed to help in these exact situations. However, oncoming traffic should not just be warned or alerted. It is also important that it is dazzled as little as possible in order to avoid accidents caused by glare and poor visibility. That is why HELLA has developed ZEROGLARE glare-free illumination that does not dazzle oncoming vehicles.



Compare traditional illumination (left) with ZEROGLARE illumination (right)



Glare-free ZEROGLARE illumination



Video clip – ZEROGLARE
Scan, watch and find out more.

ZEROGLARE technology for glare-free illumination

In order to transfer the same safety and convenience seen in the automotive sector to other target groups, HELLA has developed a new optical system for work lights. The ZEROGLARE system ensures that drivers in oncoming vehicles are not dazzled. Unlike the usual LED work lights, the cut-off line is very sharp and the light of the ZEROGLARE headlamp is directed specifically at the area in front of the vehicle. Several series are already available with this technology.

VISIOTECH technology – Communicating with light

With the new VISIOTECH projection technology, HELLA allows you to communicate using light by projecting various symbols and illuminations onto the ground.

This warns other vehicles or pedestrians of an oncoming vehicle. The lines projected in front of the vehicle can also be used for easier vehicle navigation. Projecting symbols can also easily and safely mark work areas. This results in increased safety and convenience during the daily work routine.

Using products with VISIOTECH technology is permitted for applications outside the StVZO (German Road Traffic Regulations). Special approvals are required for special applications on the road.



VISIOTECH technology application examples

Designed for the toughest working conditions!

Thanks to modern technologies developed using our OE know-how, HELLA work lights can withstand the most challenging environmental conditions. The headlamps' sophisticated thermal management and corrosion resistance in particular ensure a very long service life. After all, high-power illumination performance can only go unhindered if the heat can be optimally dissipated from the high-power LED headlamps. A long service life is guaranteed thanks to corrosion-resistant headlamps with special coatings or plastic housings. Go for the best quality and increase your working efficiency.



CoroSafe coating for work lights with an aluminium housing



NanoSafe coating for work lights with an aluminium housing for particularly tough applications such as mines

CoroSafe/NanoSafe

New process to combat corrosion in aluminium housings
With its new coating processes against corrosion, HELLA is once again setting standards in the durability and toughness of work lights with aluminium housings. Two additionally implemented layers in the surface coating of the work lights greatly improve their durability. The sophisticated combination of different coating methods ensures a high level of corrosion resistance and improved protection against work light damage. This means that the housing is well-protected and ideal for use in environments with large amounts of salt and water. CoroSafe is used primarily with HELLA LED reversing lights. When using the NanoSafe coating for special applications, such as mines, an additional coating is applied. This protects against corrosion in particularly tough applications.



Videoclip - CoroSafe and Thermo Pro
Scan, watch now and find out more.



Innovative heat-conducting plastic housing to combat corrosion

Compact series

Corrosion-free and lighter plastic housing
The innovative plastic housing of the Compact series boasts similar thermal conductivity properties to aluminium. This allows the LEDs to operate using the full power supply even at high ambient temperatures. Thanks to the housing's innovative plastic material, corrosion is averted and a long service life is guaranteed. In addition, the Compact scores points with its considerably reduced weight and improved vibration characteristics.

IP protection classes

Features and descriptions

What does IP protection class mean?

IP stands for International Protection. The IP protection classes are determined according to DIN 40 050, Part 9. The purpose of the norm is to provide an exact definition of the electrical equipment of vehicles against the ingress of solid foreign objects including dust, and against the ingress of water. The varying degrees of protection important for signalling systems are explained in more detail below.

Protection class IP 5K4K

Dust may only penetrate to such an extent that the function and safety are not impaired. Water that is sprayed against the housing from every direction at increased pressure must not have any damaging effect.: the water pressure is approx. 4 bar.

Protection class IP 9K

Water that is directed from high-pressure/steam-cleaning equipment onto the housing must not have any damaging effect: the water pressure is approx. 80-100 bar.

Protection class IP 6K7/IP 6K8

Dust must not penetrate. Even during temporary (IP 6K7) or permanent (IP 6K8) submersion, no water is allowed to penetrate. HELLA products meet the highest requirements and are optimally protected against all weather conditions.



Product image / Dimensions	Features
----------------------------	----------

HYPALUME

LED

- Developed specifically for mining and lighting tower applications
- Highly efficient light distribution
- Powerful LEDs illuminate the surrounding area for daylight working conditions
- Close Range, long range and extra wide illumination options
- Different versions from 24 VDC up to 240 VAC available
- Thermal management
- 5 year warranty



Features

- Light output (measured): 28,000 lumen
- Power requirement: 300 Watt
- Color temperature: 5,700 Kelvin
- Housing Material: Aluminum
- Protection: Reverse polarity, transient spike circuit protection
- > 60 VDC over-voltage protection
- Connection: 4 pin DT connector
- Mounting: Heavy Duty Stainless Steel Bracket
- Approvals: RCM, FCC, CE, IP6K7, IP 6K9K (withstands high pressure cleaning)
- Soft Start at PIN3
- 5 Dimming levels at PIN 4
- Non-stick and easy to clean surface coating
- High impact Grilamid nylon lens,
- 50 G Heavy Duty stainless steel bracket
- Mounting standing / hanging.

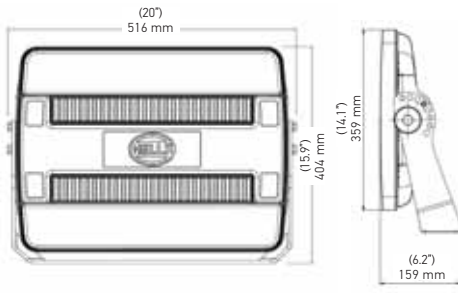

48 V	HypaLUME 48V RFCommSafe	
	Close Range	011872221
	Long Range	011872231*
	Extra Wide	011872241*

24-48 V	HypaLUME Multi-voltage 24 - 48 VCD	
	Close Range	011872501
	Long Range	011872511*
	Extra Wide	011872521*

Accessories

AC/DC Converter 320 W 24 V	358116681
AC/DC Converter 320 W 48 V	358116171
AC/DC Converter 300 W 480 VAC - 24 VCD	358116701

100-240 V AC	HypaLUME 100-240 V AC	
	Close Range	958334011
	Long Range	958334021*
	Extra Wide	958334031*

*Special order item

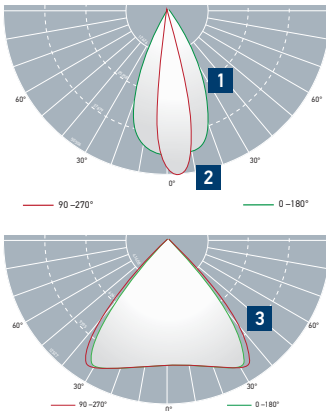

- 1** CR: Close Range
- 2** LR: Long Range
- 3** XW: Extra Wide Flood



ZEROGLARE

Bringing Onroad Safety to Mining

HELLA Mining has developed the **ZEROGLARE** optical system to bring the safety and comfort of highway driving to mining operations! The **ZEROGLARE** optical system ensures no light from oncoming traffic will be directed into the eyes of oncoming drivers eliminating the occurrence of discomfort or disability glare. The innovative optical system has a sharp horizontal cut off to control the light onto the ground in front of the vehicle and not into oncoming operators field of vision.



The **ZEROGLARE** optical system ensures all emitted light is directed below the horizontal plane



With **ZEROGLARE**

Scan for Video on ZEROGLARE



Product image / Dimensions	Features	Technical Specifications	Part Number
----------------------------	----------	--------------------------	-------------

RokLUME 380

LED



8000 lm

- Most powerful LED worklight in the HELLA range
- Designed for the roughest mining conditions
- Heavy Duty bracket for extra strong resistance to vibration
- Aluminum housing is protected with a special NanoSafe (non-sticky and easy to clean surface) coating
- ZEROGLARE option for non-glare illumination
- DT counterpart included
- 5 year warranty

Contains:

- 1 LED Light, mounting instructions and installation components

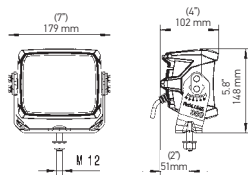

- Voltage: 20-32 VDC
- Light Output (measured): 8,000 lm
- Power Consumption: 84 Watt
- Color Temperature: 5,000 Kelvin
- Housing Material: Aluminum
- Lens Material: Hardcoated PC lens
- Connection: DT connector
- Mounting: Heavy Duty bracket
- Approvals: IP6K8, IP6K9K (withstands high pressure cleaning)

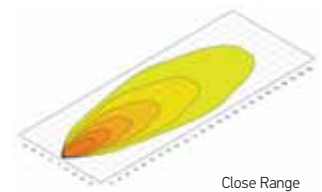
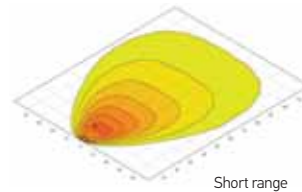

996197001	ZEROGLARE 24 V
996197011	Close Range 24 V
996197021	Longe range 24 V
996197041	Pencil beam 24 V

RokLUME 280

LED



4400 lm

- Powerful LED worklight designed for the roughest mining conditions
- Heavy Duty bracket for extra strong resistance to vibration
- Aluminum housing is protected with a special NanoSafe (non-sticky and easy to clean surface) coating
- ZEROGLARE option for non-glare illumination
- DT counterpart included
- 5 year warranty

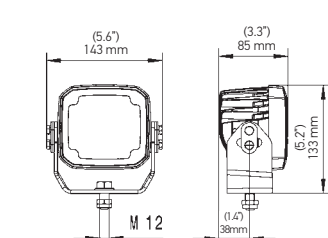

- Voltage: 9-33 VDC
- Light Output (measured): 4,400 lm
- Power Consumption: 55 Watt
- Color Temperature: 5,000 Kelvin
- Housing Material: Aluminum
- Lens Material: Hardcoated PC lens
- Connection: DT connector
- Mounting: Heavy Duty bracket
- Approvals: IP6K8, IP6K9K (withstands high pressure cleaning)

Contains:

- 1 LED Light
- Mounting instructions and installation components

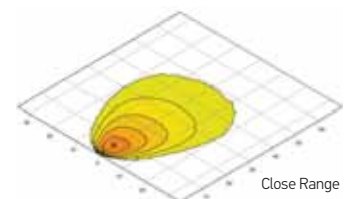

995606541	ZEROGLARE
995606501	Close Range
995606521	Pencil beam



Product image / Dimensions	Features	Technical Specifications	Part Number
----------------------------	----------	--------------------------	-------------

ULTRA BEAM LED GEN II

LED

- High performance LED worklight for various applications
- The Ultra Beam LED Gen.2 provides twice as much light as Gen. 1
- Available with standard U-bracket or the Heavy Duty surrounding bracket
- Thermo Management to secure the perfect LED temperature at all times
- 2 year warranty

- Voltage: 9-33 VDC
- Light Output (measured): 4,000 lm
- Power Consumption: 55 Watt
- Color Temperature: 6,500 Kelvin
- Housing Material: Aluminum
- Lens Material: PC
- Connection: DT connector
- Mounting: Stainless steel U-bracket / Heavy Duty bracket
- Approvals: IP6K8, IP6K9K (withstands high pressure cleaning)

- 995606001** Close Range
- 995606011** Long Range
- 995606071** Close Range HD bracket
- 995606081** Long Range HD bracket

- Contains:**
- 1 LED Light
 - Mounting instructions and installation components

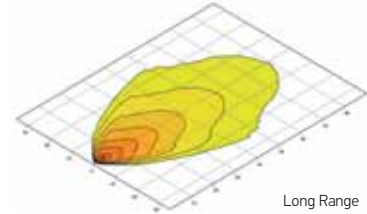
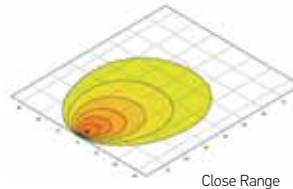
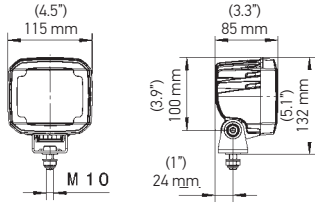

4000 lm

POWER BEAM 1500 LED

LED

- Compact and robust LED worklight
- Heavy Duty bracket for strong vibration resistance and 180 degree mounting
- Plastic cover on the back functions as handle for easy angle adjustments
- Thermo Management to secure the perfect LED temperature at all times
- 2 year warranty

- Voltage: 9-33 VDC
- Light Output (measured): 1,350 lm
- Power Consumption: 22 Watt
- Color Temperature: 6,500 Kelvin
- Housing Material: Aluminum
- Lens Material: PC
- Connection: DT connector
- Mounting: Heavy Duty bracket
- Approvals: IP6K8, IP6K9K (withstands high pressure cleaning)

- 996288021** Long Range
- 996288031** Close Range

- Contains:**
- 1 LED Light
 - Mounting instructions and installation components

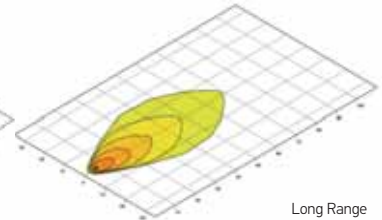
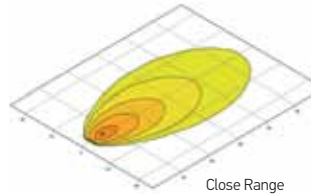
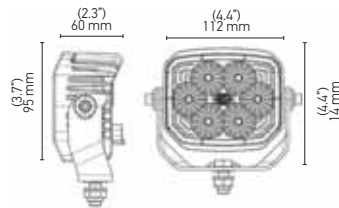

1350 lm

ROKLUME 190 TP

LED

- Thermo-conductive plastic housing for 100% corrosion resistance
- Reinforced fiber-glass plastic U-bracket withstands even the hardest impacts
- Thermo Management to secure the perfect LED temperature at all times
- Ideal for service pick-up trucks on mine-sites, tow trucks and construction vehicles
- 2 year warranty

- Voltage: 10.5-32 VDC
- Light Output (measured): 1,850 lm
- Power Consumption: 26 Watt
- Color Temperature: 5,000 Kelvin
- Housing Material: Thermo Plastic
- Lens Material: PC
- Connection: DT connector
- Mounting: Reinforced fibre-glass bracket
- Approvals: IP6K8, IP6K9K (withstands high pressure cleaning)

- 996488501** Close Range
- 996488511** Long Range

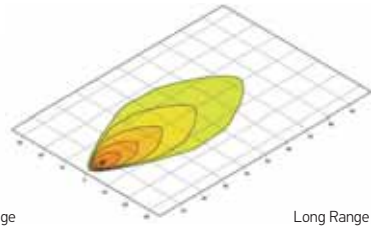
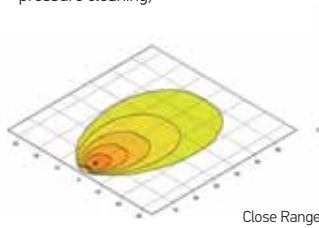
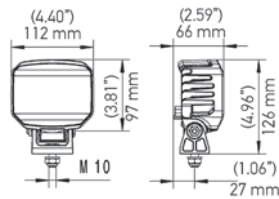

1850 lm

ROKLUME 155 TP

LED

- Compact thermo-conductive plastic housing for 100% corrosion resistance
- Reinforced fiber-glass plastic U-bracket withstands even the hardest impacts
- Thermo Management to secure the perfect LED temperature at all times
- Ideal for service pick-up trucks on mine-sites, tow trucks and construction vehicles
- 2 year warranty

- Voltage: 9-33 V
- Light Output (measured): 1,200 lm
- Power Consumption: 15 Watt
- Color Temperature: 5,000 Kelvin
- Housing Material: Thermo Plastic
- Lens Material: PC
- Connection: 12" cable with DT connector
- Mounting: Reinforced fibre-glass bracket
- Approvals: IP6K8, IP6K9K (withstands high pressure cleaning)

- 996284051** Close Range
- 996284061** Long Range

- Contains:**
- 1 LED Light
 - Mounting instructions

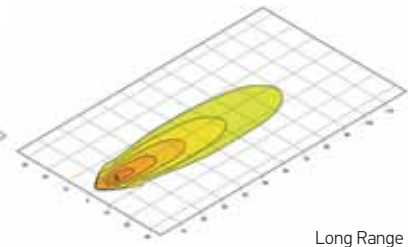
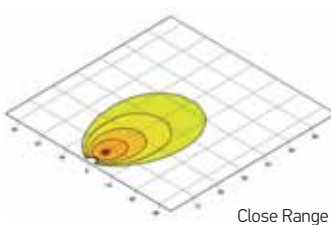
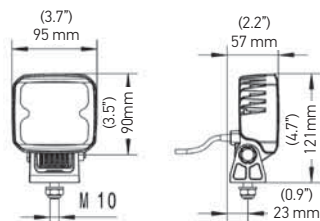

1200 lm

Product image / Dimensions	Features	Technical Specifications	Part Number
----------------------------	----------	--------------------------	-------------

MODULE 70 LED GEN 4

2500 lm
LED

- Most powerful HELLA LED worklight in this round size
- 3 Powerful multichip LEDs generate a widespread homogenous light distribution
- Thermo Management to secure the perfect LED temperature at all times
- LED searchlight comes with handle, switch and spiral cable with lighter plug
- 2 year warranty

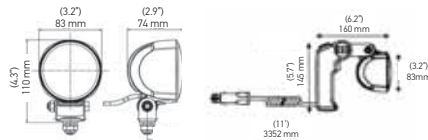

- Voltage: 9 -33 VDC
- Light Output (measured): 2,500 lm
- Power Consumption: 30 Watt
- Color Temperature: 6,500 Kelvin
- Housing Material: Aluminum
- Lens material: Glass
- Connection: 6.5ft cable with open wires / Searchlight: 11ft spiral cable with lighter plug
- Mounting: Stainless steel / handle with switch
- Approvals: IP6K8, IP6K9K (withstands high pressure cleaning)

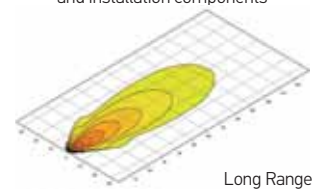
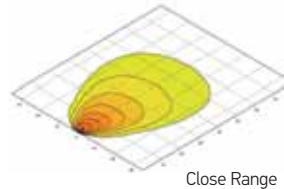
996476001 Close Range

996476011 Long Range

996476501* Spot Light Searchlight

996476511* Close Range Searchlight

*Special order item

Contains:

- 1 LED Light, mounting instructions and installation components

MODUL 70 LED GEN 3.2

1800 lm
LED

- The new Generation 3.2 provides 2x the light than the old Module 70 LED Gen. 3
- Compact size perfect for various applications
- Homogenous light distribution generates perfect working conditions around your vehicle
- Thermo Management to secure the perfect LED temperature at all times
- 2 year warranty

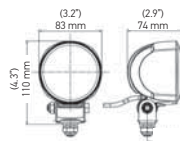

- Voltage: 9-33 VDC
- Light Output (measured): 1,800 lm
- Power Consumption: 20 Watt
- Color Temperature: 6,500 Kelvin
- Housing Material: Aluminum
- Lens Material: Glass
- Connection: 6.5ft cable with open wire leads
- Mounting: Stainless steel bracket
- Approvals: IP6K8, IP6K9K (withstands high pressure cleaning)

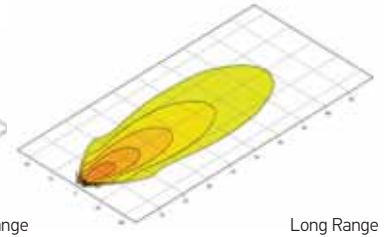
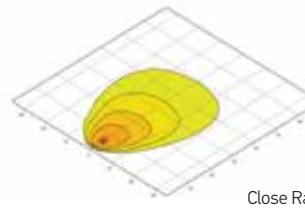
996576031 Close Range

996576001 Long Range

Contains:

- 1 LED Light
- Mounting instructions and installation components

OVAL 90 LED GEN 2

5000 lm
LED

- High performance LED worklight for various applications
- The Oval 90 LED Gen.2 provides 2x as much light as Gen. 1
- Curved lens provides an extra wide spread illumination to the outer areas
- Thermo Management to secure the perfect LED temperature at all times
- 2 year warranty

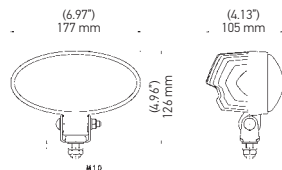

- Voltage: 9-33 VDC
- Light Output (measured): 5,000 lm
- Power Consumption: 60 Watt
- Color Temperature: 6,500 Kelvin
- Housing Material: Aluminum
- Lens Material: PC
- Connection: DT connector
- Mounting: Stainless steel bracket
- Approvals: IP6K8, IP6K9K (withstands high pressure cleaning)

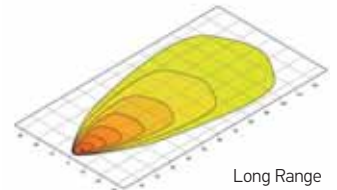
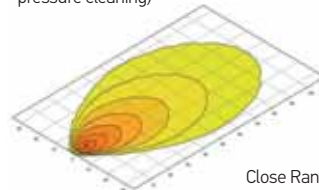
996486001 Close Range

996486011 Long Range

Contains:

- 1 LED Light
- Mounting instructions and installation components

OVAL 100 LED GEN 2

4400 lm
LED

- High performance LED worklight for various applications
- The Oval 100 LED Gen.2 provides 2x as much light as Gen. 1
- Oval design gives the light a very modern look
- Thermo Management to secure the perfect LED temperature at all times
- 2 year warranty

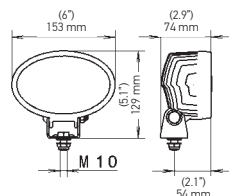

- Voltage: 9-33 VDC
- Light Output (measured): 4,400 lm
- Power Consumption: 56 Watt
- Color Temperature: 6,500 Kelvin
- Housing Material: Aluminum
- Lens Material: PC
- Connection: DT connector
- Mounting: Stainless steel bracket
- Approvals: IP6K8, IP6K9K (withstands high pressure cleaning)

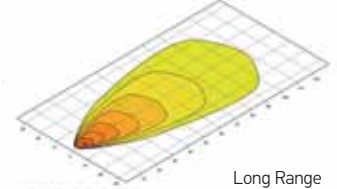
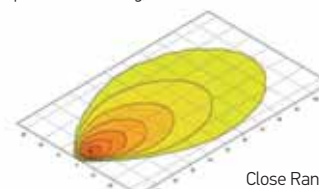
996761001 Close Range

996761011 Long Range

Contains:

- 1 LED Light
- Mounting instructions and installation components



Product image / Dimensions	Features	Technical Specifications	Part Number
----------------------------	----------	--------------------------	-------------

OVAL 100 H3



HALOGEN

- Classic oval halogen worklight
- HELLA Free-Form reflector optimizes light distribution
- H3 bulb included
- 2 year warranty

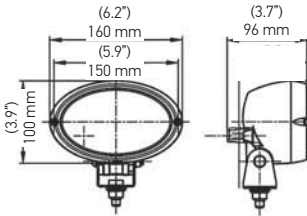

- Voltage: 12 VDC
- Light Output (measured): 1,150 lm / 2,300 lm
- Power Consumption: 55 / 110 Watt
- Color Temperature: 2,500 Kelvin
- Housing Material: HD Plastic
- Lens Material: Glass
- Connection: 6 " cable with open wire leads
- Mounting: Stainless Steel bracket
- Protection: IP5K9K (pressure cleaner proof)

996361271

Close Range

358115061 (H15161031)

Long Range
2 X H3

Contains:

- 1 Halogen Light
- Mounting instructions and installation components

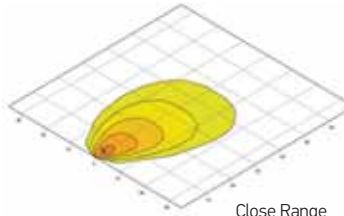

Close Range

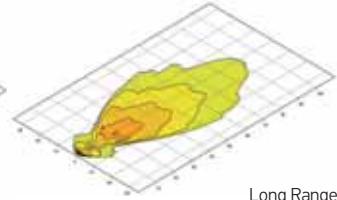

Long Range

1150 lm

ULTRA BEAM H3



HALOGEN

- The classic halogen worklight
- HELLA Free-Form reflector technology optimizes light distribution
- H3 bulb included
- 2 year warranty

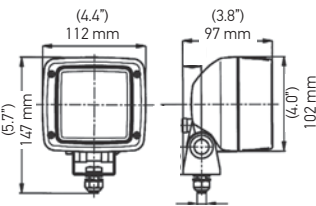

- Voltage: 12 VDC
- Light Output (measured): 1,150 lm
- Power Consumption: 55 Watt
- Color Temperature: 2,500 Kelvin
- Housing Material: HD Plastic
- Lens Material: Glass
- Connection: AMP connector with 4 " cable with open wires
- Mounting: Stainless Steel bracket
- Protection: IP5K9K (pressure cleaner proof)

358115111 (H15506021) Close Range

Contains:

- 1 Halogen Light
- Mounting instructions and installation components

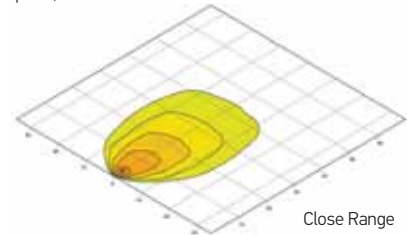

Close Range

1150 lm

MODULE 70 H3



HALOGEN

- Compact halogen worklight for applications with tight mounting options
- Easily accessible H3 bulb (included) - no tools required for bulb replacement
- Cable feed through an opening in the rubber cap
- 2 year warranty

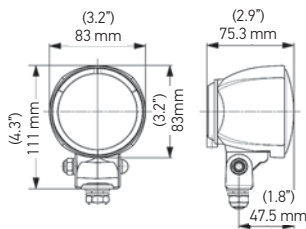

- Voltage: 12 VDC
- Light Output (measured): 1,150 lm
- Power Consumption: 55 Watt
- Color Temperature: 2,500 Kelvin
- Housing Material: HD Plastic
- Lens Material: Glass
- Connection: Cable with open wire leads
- Mounting: Stainless Steel bracket
- Protection: IP5K9K (pressure cleaner proof)

996176491

Close Range
Flush mount

Contains:

- 1 Halogen Light
- Mounting instructions and installation components

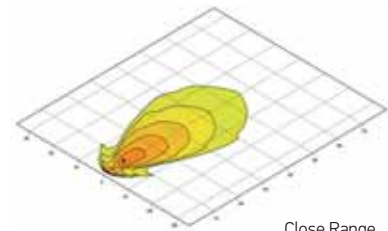

Close Range

1150 lm

MATADOR H3



HALOGEN

- Halogen worklight with protective grill to protect glass lens from rock chips
- 4-point Omega bracket for versatile surface mounting options
- Comes with an integrated switch
- H3 bulb included
- 2 year warranty

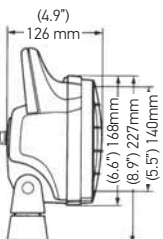

- Voltage: 12 VDC / 24 VDC
- Light Output (measured): 1,150 lm / 1,300 lm
- Power Consumption: 55 Watt / 70 Watt
- Color Temperature: 2,500 Kelvin
- Housing Material: HD Plastic
- Lens Material: Glass
- Connection: Cable with open wire leads
- Mounting: Stainless Steel bracket
- Protection: IP5K9K (pressure cleaner proof)

358115281 (H15470001) 12V Close Range

003470911 (H15470011) 24V Close Range

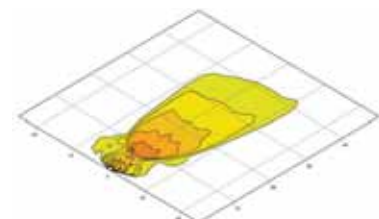

1150 lm

Product image / Dimensions	Features	Technical Specifications	Part Number
----------------------------	----------	--------------------------	-------------

C140 LED HEADLAMPS
LED

- Upgrade your vehicle with HELLAs latest LED snowplow lights
- All four light functions in LED: high beam, low beam, direction indicator and PO light
- Integrated 6-pin DT connector for a sealed and safe connection
- 2 year warranty

- Voltage: 10 - 32 VDC
- Power Consumption: 25 / 40 Watt
- Light Output: Low Beam, High Beam, Indicator, Position
- Color Temperature: 6,000 Kelvin
- Housing Material: Aluminum
- Lens Material: PC
- Connection: 6 pin DT connector
- Mounting: HD stainless steel bracket
- Approvals: ECE, SAE, IP6K9K (withstands high pressure cleaning)

996374011 Left
996374021 Right

- Contains:**
- 1 LED Light
 - Mounting instructions and installation components

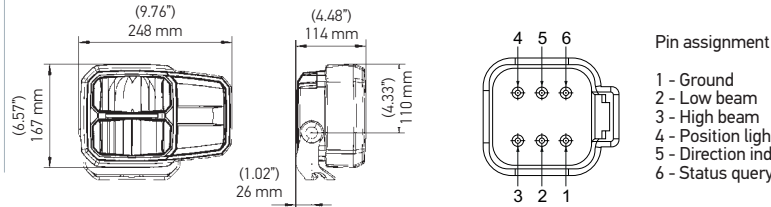

C220 COMBINATION HEADLAMPS
HALOGEN

- Stylish combination headlights / snowplow light
- HELLA Free-Form reflector technology provides superior illumination
- Heavy Duty vibration dampened mounting stud bracket
- 12V bulbs are included
- 2 year warranty

- Voltage: 12 VDC
- Light Output: Low Beam, High Beam, Indicator, Position
- Color Temperature: 2,500 Kelvin
- Housing Material: HD Plastic
- Lens Material: Glass
- Connection: 6 pin DT connector
- Mounting: Heavy Duty stud bracket
- Approvals: ECE, IP5K9K (pressure cleaner proof)
- Light Source: 12 V H7/H3/P21W/T4W

996174251 Left
996174261 Right

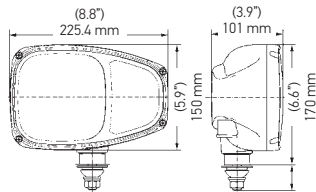
- Contains:**
- 1 Halogen Light
 - Mounting instructions and installation components



2500 lm
C120 COMBINATION HEADLAMPS
HALOGEN

- Oval shaped combination headlights / snowplow light
- HELLA Free-Form reflector technology provides superior illumination
- Heavy Duty vibration dampened stud mounting bracket
- 12V bulbs are included
- 2 year warranty

- Voltage: 12 VDC
- Light Output: Low Beam, High Beam, Indicator, Position
- Color Temperature: 2,500 Kelvin
- Housing Material: HD Plastic
- Lens Material: Glass
- Connection: 6 pin DT connector
- Mounting: Surface or bracket mount
- Approvals: ECE, SAE, IP5K9K (pressure cleaner proof)
- Light Source: 12 V H7/H3/P21W/T4W

996167051 Left
996167061 Right
996167191 Left, Stud
996167201 Right, Stud

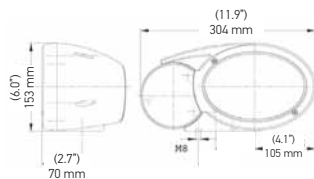
- Contains:**
- 1 Halogen Light
 - Mounting instructions and installation components



2500 lm
M120 COMBINATION HEADLAMPS
HALOGEN

- Classic square shaped combination headlights / snowplow light
- HELLA Free-Form reflector technology provides superior illumination
- Heavy Duty vibration dampened stud mounting bracket
- 12 V bulbs are included
- 2 year warranty

- Voltage: 12 VDC
- Light Output: Low Beam, High Beam, Indicator, Position
- Color Temperature: 2,500 Kelvin
- Housing Material: HD Plastic
- Lens Material: Glass
- Connection: 6 pin DT connector
- Mounting: Heavy Duty stud bracket
- Approvals: ECE, IP5K9K (pressure cleaner proof)
- Light Source: 12 V H7/H3/P21W/T4W

996120051 12V, Left
996120061 12V, Right
996081277 12V, Vertical

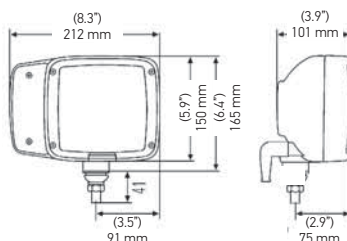
- Contains:**
- 1 Halogen Light
 - Mounting instructions and installation components

996081277

2500 lm

DISCOVER: LIGHT BARS HELLA OWS
FULL SIZE! Available in 48", 56" and 60",
as well as the HELLA MINI LIGHT BAR 10"
and 16"





OPTICAL WARNING SYSTEMS

The Optical Warning Systems (OWS), the KL series signaling systems, the rotating lamps, beacons and their constant technological implementations make HELLA products so special. Rotating lamps, flashers, warning lights: this is where our specialists combine the best technology with extreme resistance. The result: high-quality LED technology, modern reflector technology, which resists even the toughest weather and working conditions as well as a continuous service without compromising its operation.

HELLA allows you to be absolutely safe and visible at all times.



MICROSITE: Find more information at:



www.hellahd.com



HELLA FULL SIZE LED LIGHTBAR



- Choose from 8 different lightbar options varying in sizes to fit your car, truck or light commercial vehicle
- Available in lengths of 48", 56" and 60"
- Stop/Tail/Turn Alley Lights and Take-Down Light options
- Smoked lens design for a stealth look
- All lightbars come with integrated traffic director functionality
- Easy maintenance with top accessibility
- Can be mounted permanently or temporarily using strap kits
- 5 year warranty



Technical Data	
Voltage:	10-30 VDC
Flash Pattern:	29 user selectable flash pattern
Approvals:	SAE J845 Class 1 , California Title 13
Colors:	Amber, Red, Blue, Green
Power Consumption:	103 / 130 / 143 / 182 Watt
Mounting:	Bracket or vehicle specific strap kits (separate purchase)
Connection:	10ft cable with open wire leads
IP Rating	IP 67

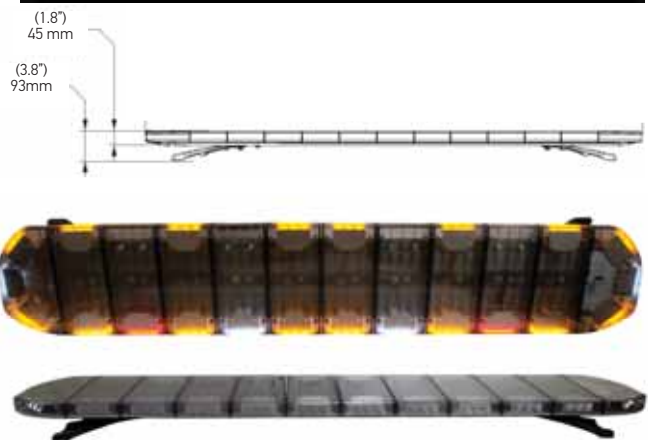

Description	Color	Part Number
LB4800A	● LED Light Bar, 48", Amber	358111781 (H27941001)
LB4800AL	● LED Light Bar, 48", Amber, with takedown and alley lights	358111871 (H27941091)
LB4800AGL	●● LED Light Bar, 48", Amber / Green, with takedown and alley lights	358111821* (H27941041)
LB4800RBL	●● LED Light Bar, 48", Red / Blue, with takedown and alley lights	358111841* (H27941061)
LB4800RL	● LED Light Bar, 48", Red, with takedown and alley lights	358111851* (H27941071)
LB4800BL	● LED Light Bar, 48", Blue, with takedown and alley lights	358111861* (H27941081)
LB5600AL	● LED Light Bar, 56", Amber, with stop, tail, turn, takedown and alley lights	358111801 (H27941021)
LB6000AL	● LED Light Bar, 60", Amber, with stop, tail, turn, takedown and alley lights	358111811 (H27941031)

* Special order item

358111781

358111871

358111821

358111841

358111851

358111861

358111801

358111811

Description

- LED amber module
- LED green module
- LED red module
- LED blue module
- Flasher
- Takedown light
- Alley Lights

HELLA LED LIGHT BAR STRAP KITS



Applications	Years	Part Number
CHEVY IMPALA	2014 - 2015	358115551 (H27942011)
CHEVY SILVERADO	2014 - 2018	358115561 (H27942021)
CHEVY TAHOE	2007 - 2014	358115571 (H27942031)
GMC YUKON	2001 - 2014	358115581 (H27942041)
DODGE CHARGER	2011 - 2020	358115591 (H27942051)
DODGE RAM 1500	2012 - 2019	358115601 (H27942061)
DODGE RAM 1500-3500	2010 - 2011	358115611 (H27942081)
FORD EXPLORER	2013 - 2019	358115631 (H27942101)
FORD F150 - F550	2015 - 2020	358115641 (H27942111)
FORD F150	2004 - 2014	358115651 (H27942121)
FORD F250 - 550	1999 - 2016	358115661 (H27942131)
FORD TAURUS	2013 - 2019	358115671 (H27942141)

HELLA LED LIGHT BAR CONTROLLER



- 360 adjustable bracket mounting
- Seven auxiliary functions can be switched
- Independent control of power
- Mounted to any angled surface
- Supports controlling of light bar and traffic advisor
- Audio and visible feedback

Description	
HELLA LED Light Bar Controller	358115681 (H27943001)



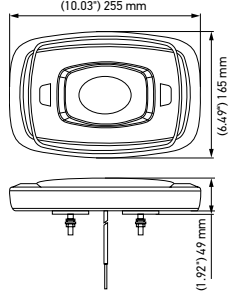

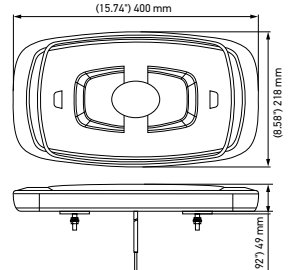

Product image / Dimensions	Features	Technical Specifications	Part Number
 <p>10" MINI LIGHTBAR</p>	<p>LED</p> <ul style="list-style-type: none"> • 10" mini lightbar • Amber light output in both clear and amber lenses • Multiple user selectable flashing options including rotating pattern • Bracket or magnetic mounting options • 5 year warranty 	<ul style="list-style-type: none"> • Voltage: 10-30 VDC • Flash Pattern: 10 user selectable flash pattern • Approval: SAE J845 Class 1, ECE-R10, EMC CISPR 25 Class 3, IP6K9K (withstands high pressure cleaning) • Colors: Amber, Amber/White • Power Consumption: 70 Watt • Mounting: Fixed or Magnet mount • Connection: Fixed mount: 20" cable with open wire leads, Magnet: 10ft spiral cable with lighter plug + switches 	<p>014566111 Fixed, Clear Lens, Amber</p>
			<p>014566311* Fixed, Amber Lens, Amber</p> <p>014566411 Fixed, Clear Lens, Amber/White</p> <p>014566121 Magnet, Clear Lens, Amber</p> <p>014566321* Magnet, Amber Lens, Amber</p> <p>014566421 Magnet, Clear Lens, Amber/White</p>
<p>NEW</p>			

* Special order item

 <p>16" MINI LIGHTBAR</p>	<p>LED</p> <ul style="list-style-type: none"> • 16" mini lightbar • Amber light output in both clear and amber lenses • Multiple user selectable flashing options including rotating pattern • Bracket or magnetic mounting options • 5 year warranty 	<ul style="list-style-type: none"> • Voltage: 10-30 VDC • Flash Pattern: 10 user selectable flash pattern • Approval: SAE J845 Class 1, ECE-R10, EMC CISPR 25 Class 3, IP6K9K (withstands high pressure cleaning) • Colors: Amber, Amber/White • Power Consumption: 70 Watt • Mounting: Fixed or Magnet mount • Connection: Fixed mount: 20" cable with open wire leads, Magnet: 10ft spiral cable with lighter plug + switches 	<p>014565111 Fixed, Clear Lens, Amber</p>
			<p>014565311* Fixed, Amber Lens, Amber</p> <p>014565411 Fixed, Clear Lens, Amber/White</p> <p>014565121 Magnet, Clear Lens, Amber</p> <p>014565321* Magnet, Amber Lens, Amber</p> <p>014565421 Magnet, Clear Lens, Amber/White</p>
<p>NEW</p>			

* Special order item

 <p>MLB 50 LED</p>	<p>LED</p> <ul style="list-style-type: none"> • 14" classic design mini lightbar • Low power function for night time use • Available in permanent and vacuum magnet mount • 5 year warranty 	<ul style="list-style-type: none"> • Voltage: 10-30 VDC • Flash Pattern: 24 user selectable flash pattern • Approval: SAE J845 Class 1, California Title 13, ECE-R10 • Colors: Amber, Amber/White • Power Consumption: 70 Watt • Mounting: Fixed, Magnet mount • Connection: Fixed mount: 10" cable with open wire leads, Magnet: 10ft spiral cable with lighter plug + switches 	<p>358111431 (H27995001) Fixed Amber</p>
			<p>358111441 (H27995011) Magnet, Amber</p> <p>358111451 (H27995021) Fixed Amber/White</p> <p>358111461 (H27995031) Magnet Amber/White</p>
			

 <p>MLB 100 LED LIGHT BAR</p>	<p>LED</p> <ul style="list-style-type: none"> • Non-volatile memory recalls last flash pattern • Multiple units can be synchronized • Reverse polarity protection • Weatherproof and vibration resistant design for external use • 5 year warranty 	<ul style="list-style-type: none"> • Light Source: 30 LEDs • Warning Patterns: 23 Flash Patterns • Operating Voltage: 12 / 24 VDC • Max Power: 50 W • Approvals: SAE J845 Class 1, California Title 13, ECE R65, ECE R10 • Connection Fixed: 12" (30 cm) wire leads • Connection Magnet: 10' (3 m) lighter plug with on/off and pattern select switch • Multi-Unit Sync: Over 15 units • Operating Temperature: -30°C to +60°C • IP Rating: IP67 	<p>358111471 (H27996001) Fixed Amber</p>
			<p>358111481 (H27996011) Magnet Amber</p> <p>358111511 (H27996041) Fixed Amber/White</p> <p>358111521 (H27996051) Magnet Amber/White</p> <p>358111531* (H27996061) Fixed Red/Blue</p> <p>358111541* (H27996071) Magnet Red/Blue</p> <p>358111551* (H27996081) Fixed Blue</p>
			

* Special order item







Product image / Dimensions	Features	Technical Specifications	Part Number
MLB 200 LED LIGHT BAR 	LED <ul style="list-style-type: none"> • 16" low profile warning lightbar (just 1.4" height) • Available in various colors and different mounting options • Weatherproof and vibration resistant • 5 year warranty 	<ul style="list-style-type: none"> • Voltage: 10-30 VDC • Flash Pattern: 24 user selectable flash pattern • Approval: SAE J845 Class 1, California Title 13, ECE-R10 • Colors: Amber, Amber/White • Power Consumption: 74 Watt • Mounting: Fixed, Magnet mount • Connection: Fixed mount: 10" cable with open wire leads, Magnet: 10ft spiral cable with lighter plug + switches 	358111561 (H27997001) Fixed Mount Amber
			358111571 (H27997011) Magnet Mount Amber
			358111581 (H27997021) Fixed Mount Amber/White
			358111591 (H27997031) Magnet Mount Amber/White

MLB 200 LED COLOR DUAL LIGHT BAR 	LED <ul style="list-style-type: none"> • 16" low profile warning lightbar (just 1.4" height) • Dual memory allows for easy switching between two different color modes • Available in various colors and different mounting options • 5 year warranty 	<ul style="list-style-type: none"> • Voltage: 10-30 VDC • Flash Pattern: 24 user selectable flash pattern • Approval: SAE J845 Class 1, California Title 13, ECE-R10 • Colors: Amber/White, Amber/Blue • Power Consumption: 72 Watt • Mounting: Fixed, Magnet mount • Connection: Fixed mount: 10" cable with open wire leads, Magnet: 10ft spiral cable with lighter plug + switches 	358111601 (H27997501) Fixed Mount Amber/White
			358111611 (H27997511) Magnet Mount Amber/White
			358111621 (H27997521) Fixed Mount Amber/Blue
			358111631 (H27997531) Magnet Mount Amber/Blue

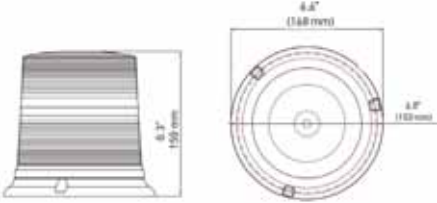
K-LED 100 LED 	LED <ul style="list-style-type: none"> • Modern round beacon (SAE J845 Class 1) • High and compact low dome option • Various mounting options including the DIN pole mount • 5 year warranty 	<ul style="list-style-type: none"> • Voltage: 10-30 VDC • Flash Pattern: 11 / 14 user selectable flash pattern • Approval: SAE J845 Class 1, California Title 13, ECE R65, ECE R10 • Color: Amber • Power Consumption: 42 / 30 Watt • Mounting: Fixed, Magnet, Pole mount • Connection: Fixed mount: 10" cable with open wire leads, Magnet: 10ft spiral cable with lighter plug + switches 	358113811 (H27112001) Fixed Mount
			358114791 (H27112011) Magnet
			358114801 (H27112031) DIN Pole

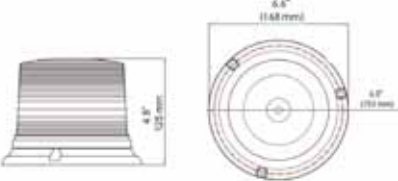
K-LED 100 COMPACT LED 	LED <ul style="list-style-type: none"> • Modern round beacon (SAE J845 Class 1) • High and compact low dome option • Various mounting options including the DIN pole mount • 5 year warranty 	<ul style="list-style-type: none"> • Voltage: 10-30 VDC • Flash Pattern: 11 / 14 user selectable flash pattern • Approval: SAE J845 Class 1, California Title 13, ECE R65, ECE R10 • Color: Amber • Power Consumption: 42 / 30 Watt • Mounting: Fixed, Magnet, Pole mount • Connection: Fixed mount: 10" cable with open wire leads, Magnet: 10ft spiral cable with lighter plug + switches 	358114821 (H27114001) Fixed Mount
			358114831 (H27114011) Magnet
			358118041 Fixed Mount, 14 FP, bulk 20 pcs
			358118051 Fixed Mount, 14 FP, bulk 20 pcs

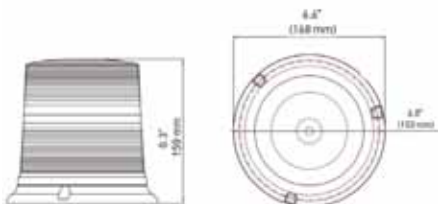

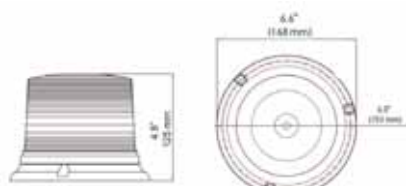
Product image / Dimensions	Features	Technical Specifications	Part Number
<p>K-LED 50</p> 	<p>LED</p> <ul style="list-style-type: none"> • Modern round beacon (SAE J845 Class 1) • High and compact low dome option • Available in amber and white • 5 year warranty 	<ul style="list-style-type: none"> • Voltage: 10-30 VDC • Flash Pattern: 15 user selectable flash pattern • Approval: SAE J845 Class 1, ECE R10 • Colors: Amber, White • Power Consumption: 22 Watt • Mounting: Fixed, Magnet mount • Connection: Fixed mount: 16 " cable with open wire leads, Magnet: 10ft spiral cable with lighter plug + switches 	<p>358114761 (H27111001) Fixed Mount</p> <p>358114771 (H27111011) Magnet</p> <p>358114781 (H27111101) White, Fixed Mount</p>
<p>K-LED 50 COMPACT</p> 	<p>LED</p> <ul style="list-style-type: none"> • Modern round beacon (SAE J845 Class 1) • High and compact low dome option • Available in amber and white • 5 year warranty 	<ul style="list-style-type: none"> • Voltage: 10-30 VDC • Flash Pattern: 15 user selectable flash pattern • Approval: SAE J845 Class 1, ECE R10 • Colors: Amber, White • Power Consumption: 22 Watt • Mounting: Fixed, Magnet mount • Connection: Fixed mount: 16 " cable with open wire leads, Magnet: 10ft spiral cable with lighter plug + switches 	<p>358114811 (H27113001) Fixed Mount</p> <p>358113821 (H27113011) Magnet</p>
<p>K-LED 40</p> 	<p>LED</p> <ul style="list-style-type: none"> • Perfect entry level LED beacon (SAE J845 Class 2) • High and compact low dome option • Available as permanent fixed mount or temporarily magnet mount • 5 year warranty 	<ul style="list-style-type: none"> • Flash Pattern: 5 user selectable flash pattern • Approval: SAE J845 Class 2 • Color: Amber • Power Consumption: 3 Watt • Mounting: Fixed, Magnet mount • Connection: Fixed mount: 16 " cable with open wire leads, Magnet: 10ft spiral cable with lighter plug + switches 	<p>358114701 (H27117001) Fixed Mount</p> <p>358114711 (H27117011) Magnet</p>
<p>K-LED 40 COMPACT</p> 	<p>LED</p> <ul style="list-style-type: none"> • Perfect entry level LED beacon (SAE J845 Class 2) • High and compact low dome option • Available as permanent fixed mount or temporarily magnet mount • 5 year warranty 	<ul style="list-style-type: none"> • Flash Pattern: 5 user selectable flash pattern • Approval: SAE J845 Class 2 • Color: Amber • Power Consumption: 3 Watt • Mounting: Fixed, Magnet mount • Connection: Fixed mount: 16 " cable with open wire leads, Magnet: 10ft spiral cable with lighter plug + switches 	<p>358114681 (H27115001) Fixed Mount</p> <p>358114691 (H27115011) Magnet</p>

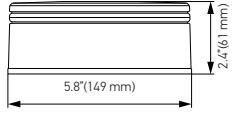
Product image / Dimensions	Features	Technical Specifications	Part Number
K-LED REBELUTION 	<p>LED</p> <ul style="list-style-type: none"> • Innovation and change – that's what the KLED • Rebelution beacon stands for. The narrow light exit area is setting new standards in the beacon market. The most striking feature of the KLED Rebelution is its unique and unconventional design. It manages without a classical dome and impresses with its discreet, futuristic styling. • The low profile design gives it a stealth look for a perfect vehicle design integration. • 2 year warranty 	<ul style="list-style-type: none"> • Voltage: 10-30 VDC • Flash Pattern: flashing (1 pattern) or rotating (1 pattern/speed) • Approval: ECE-R65, SAE Class 2 (outstanding) • Color: Amber • Power Consumption: 38 / 13 Watt • Mounting: Fixed mount • Connection: 6 " cable with open wire leads, 	455255001 Fixed, flashing
			455256001 Fixed, rotating
			

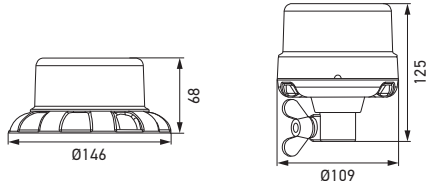
K-LED NANO NEW 	<p>LED</p> <ul style="list-style-type: none"> • The HELLA K-LED Nano is the smallest beacon in the HELLA range to date. Despite its compact dimensions, it achieves an attention-grabbing warning effect with its flashing, long-range amber light signal. Thanks to the energy-efficient, long-life LED technology, the warning signal is generated without moving parts • Vibration and impact-resistant • High degree of tightness thanks to complete sealing • 2 year warranty 	<ul style="list-style-type: none"> • Voltage: 12VDC / 24 VDC • Flash Pattern: flashing warning signal • Approval: SAE, CISPR 25 Class, ADR/GGVS, ECE-R65, ECE-R10, RCM • Color: Amber • Protection: IP6K7, IP6K9 • Power Consumption: 5 Watt • Mounting: Fixed mount and Pipe mount • Connection: 150 mm cable with 6.3 x 0.8 – 1.5 flat connector 	006146001 Fixed Mount
			006146011 Pipe Mount
			

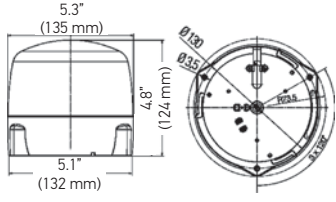
ROTALED 	<p>LED</p> <ul style="list-style-type: none"> • The classic HELLA LED beacon (SAE J845 Class 1, CT13, ECE,...) • Fulfills all legal requirements • Low energy consumption makes this beacon ideal for continued use • 2 year warranty 	<ul style="list-style-type: none"> • Voltage: 10-30 VDC • Flash Pattern: 5 user selectable flash pattern • Approval: SAE J845 Class 1, ECE R65, ECE R10, CISPR25 Class 5 • Color: Amber • Power Consumption: 10 Watt • Mounting: Fixed, Flex mount • Connection: Fixed mount: cable with open wire leads, Flex: DIN plug 	010979001 Fixed Mount
			010979011 Flex Mount
			

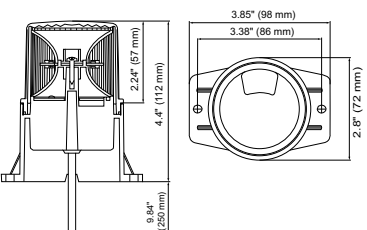
FL MINI 	<p>LED</p> <ul style="list-style-type: none"> • Super compact LED beacon (SAE J845 Class 3) • Wide voltage range up to 80 VDC • Designed for Forklifts with UL approval • 2 year warranty 	<ul style="list-style-type: none"> • Voltage: 10-80 VDC • Flash Pattern: 1 flashing pattern • Approval: ECE, SAE J845 Class 3, UL • Color: Amber • Power Consumption: 8 Watt • Mounting: Fixed mount • Connection: Fixed mount: 10 " cable with open wire leads 	014959111 Fixed Mount
			



Product image / Dimensions	Features	Technical Specifications	Part Number
----------------------------	----------	--------------------------	-------------

HELLA VALUEFIT SLIM

NEW



LED

- Round beacon, modern design
- Die-cast aluminum housing contributes to high thermal efficiency.
- Available in Amber
- Number of LEDs: 24
- Type of protection: IP67, IP 6K9K
- Protection against polarity reversal and overvoltage
- 5 year warranty

- Voltage: 10-30 VDC
- Flash pattern: 2 patterns: Single and double
- Approval: SAE J845 Class 1, ECE R65, ECE R10,
- Color: Amber
- Power consumption: 10 Watt
- Housing and dome material: PC
- Mounting: Fixed
- Connection: 3 m cable with open leads

357980001 Amber, Fixed
Single/double flash

357980011 Amber, Pipe
Double flash

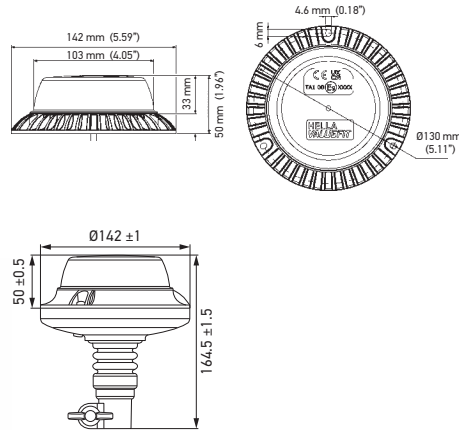

HELLA SOS 360° WARNING LIGHT

NEW



LED

- The perfect accompaniment to the warning triangle in the vehicle. The first priority in the event of any breakdown is securing of the scene of the accident. But until the warning triangle is set up, the vehicle remains unsecured – a danger for all road users that should not be underestimated, especially in the dark. This is exactly where the innovative HELLA SOS 360° warning light comes into play: once placed on the roof in a flash by means of its magnetic mount, it generates an easily perceptible amber, all-round warning signal thanks to its high-performance LEDs.
- Visible up to 1 km (0.62 miles) away.
- The SOS 360° lamp can also be used as a powerful LED torch or as a white LED work light.

- Voltage: 9 V battery operation
- Light function: Two magnetically activated light functions (amber warning light and white working light),
- Approval: CE tested
- Mounting: Magnet

359001001 SOS 360°

Warning function for greater safety
Once placed on the roof, the SOS 360° warning lamp generates an amber all-round warning light. Completely without moving parts and visible up to 1 km away. Simply safe!

Compact design, quick mounting
The SOS 360° warning lamp is easily stowed away and is always ready to hand. Can be mounted on the vehicle roof in a flash thanks to its magnetic activation feature.

Torch function for more visibility
Manual switching enables the warning lamp to be changed to a bright white continuous light, when work has to be carried out, for example, in the engine compartment. Simply practical!





Product Video:



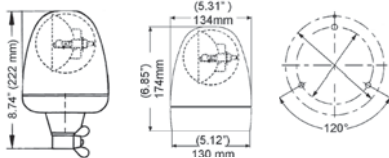

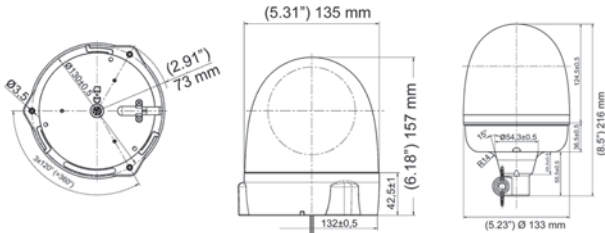
Product image / Dimensions	Features	Technical Specifications	Part Number
KL ROTAFLEX / KL ROTAFIX 	HALOGEN <ul style="list-style-type: none"> Sturdy dome with smooth easy-to-clean surface Various mounting options Fixed installation possible from the top or bottom DIN Pole flexible pipe socket with shock absorption 2 year warranty 	<ul style="list-style-type: none"> Voltage: 12 or 24 VDC Flash Pattern: Rotating 160 RPM Approval: SAE J845 Class 1, ECE R65, ECE R10 Color: Amber Power Consumption: 75 / 95 Watt Mounting: Fixed, Magnet, Flex mount Connection: Fixed mount: 7.5" cable with open wires, Magnet: 10' spiral cable with cigarette lighter plug, Flex: DIN plug 	007337001 12 V Fixed Mount
			007337021* 12 V Magnet 006846001 12 V Flex Mount 007337011 24 V Fixed Mount 007337031* 24 V Magnet 006846011 24 V Flex Mount
			* Special order item

KL ROTA COMPACT 	HALOGEN <ul style="list-style-type: none"> The classic HELLA beacon Fulfills highest legal requirements (SAE J845 Class 1, ECE,...) Modular mounting options to suit all applications 2 year warranty 	<ul style="list-style-type: none"> Voltage: 12 or 24 VDC Flash Pattern: Rotating 180 RPM Approval: SAE J845 Class 1, ECE R65, ECE R10 Color: Amber Power Consumption: 70 / 85 Watt Mounting: Fixed, Flex mount Connection: Fixed mount: 7.5" cable with open wires, Magnet: 10' spiral cable with cigarette lighter plug, Flex: DIN plug 	009506001 12 V Fixed Mount
			009506011 24 V Flex Mount 009506201 12 V Fixed Mount
			

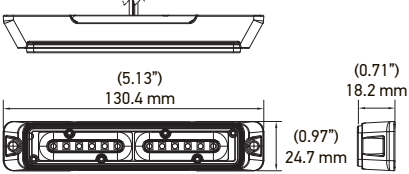
MS6-DC DUAL COLOR LIGHTHEADS 	LED <ul style="list-style-type: none"> Get twice as much for your money - optical warning strobe + worklight all in one Dual Color LED lighthouse with integrated white scene light override function Lighthouse has a comfortable 7 foot installation cable Multiple units can be grouped to flash simultaneously or alternately 5 year warranty 	<ul style="list-style-type: none"> Voltage: 10-30 VDC Light Source: 2x3 LEDs Flash Pattern: 29 user selectable flash pattern Approval: SAE J595 Class 1 Colors: Red, Blue, Amber with White override function Power Consumption: 18 Watt Housing material: Aluminum Mounting: Screw Connection: 7ft cable with open wire 	358118131 Red + Blue split / all White overwrite
			358118141 Amber + White split / all White overwrite 358118151* All Red / all Blue overwrite 358118161* All Red / all White overwrite 358118171* All Blue / all White overwrite
			* Special order item

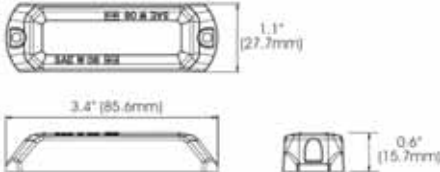
MS4 TRIPLE COLOR LIGHTHEADS 	LED <ul style="list-style-type: none"> Triple color LED warning strobe with integrated white scene light override function Multiple units can be grouped to flash simultaneously or alternately 5 year warranty 	<ul style="list-style-type: none"> Voltage: 10-30 VDC Light Source: 4x3 LEDs Flash Pattern: 21 user selectable flash pattern (incl. steady on) Approval: SAE J595 Class 1 Colors: Red, Blue, Amber, White with White override function Power Consumption: 18 Watt Housing material: Aluminum Mounting: Screw Connection: 7' cable with open wires 	358111911 (H22899001) Red/ White/ Blue
			358111921 (H22899011) Amber/ White/ Blue
			

Product image / Dimensions	Features	Technical Specifications	Part Number
<p>MST6E SLIM STROBE LIGHTHEADS</p> 	<p>LED</p> <ul style="list-style-type: none"> • Super low profile for discreet placement • Frosted lens for glowing body technology and 180 degree visibility • 5 year warranty 	<ul style="list-style-type: none"> • Voltage: 10-30 VDC • Light Source: 6 LEDs • Flash Pattern: 21 user selectable flash pattern • Approval: SAE J595 Class 1 • Colors: Amber, Blue, Red, White and Green • Power Consumption: 6 Watt • Housing material: Plastic • Mounting: Screw + 3M tape • Connection: 8" cable with open wires 	<p>358111691 (H22897001) Amber</p> <p>358111701 (H22897011) Blue</p> <p>358111711 (H22897021) White</p> <p>358111721 (H22897031) Red</p> <p>358111731 (H22897041) Green</p> <p>358111741 (H22897051) Amber/White</p> <p>358111751* (H22897061) Amber/Green</p> <p>358111771* (H22897081) Green/White</p> <p>* Special order item</p>
<p>CONCEALED LED GEN.II LIGHTHEADS</p> 	<p>LED</p> <ul style="list-style-type: none"> • Reliable LED concealed lighthouse set (2 lights, control unit, long install cables) • Pop-in design for easy installation (can be used as hideaways or for surface mounting) • Synchronized units can flash simultaneously or alternately • 5 year warranty 	<ul style="list-style-type: none"> • Voltage: 10-30 VDC • Light Source: 2x6 LEDs • Flash Pattern: 37user selectable flash pattern • Approval: SAE J595 Class 1 • Colors: Amber, White, A/W and Blue/White • Power Consumption: 12 Watt • Housing material: Aluminum • Mounting: Screw • Connection: 3ft + 10ft cable with easy connectors 	<p>358111941* (H22901001) Amber</p> <p>358111951* (H22901021) White</p> <p>358111961 (H22901031) Amber/White</p> <p>358111971* (H22901041) Blue/White</p> <p>* Special order item</p>
<p>MS6 STROBE LIGHTHEADS</p> 	<p>LED</p> <ul style="list-style-type: none"> • Classic 6 LED warning strobe • Black aluminum base for maximum heat dissipation • Fulfills all legal requirements (SAE J845 Class 1, CT13, ...) • Synchronized units can flash simultaneously or alternately • 5 year warranty 	<ul style="list-style-type: none"> • Voltage: 10-30 VDC • Light Source: 6 LEDs • Flash Pattern: 19 user selectable flash pattern • Approval: SAE J595 Class 1, California Title 13 • Colors: Amber, Blue, Red and White • Power Consumption: 10 Watt • Housing material: Aluminum • Mounting: Screw • Connection: 4" cable with open wires 	<p>358111151 (H22890001) Amber</p> <p>358111161 (H22890021) White</p> <p>358111171 (H22890031) Blue</p> <p>358111181 (H22890041) Red</p> <p>358111191 (H22890051) Amber/White</p> <p>358111201 (H22890061) Red/Blue</p> <p>358111211 (H22890071) Red/White</p>
<p>MST6 SLIM STROBE LIGHTHEADS</p> 	<p>LED</p> <ul style="list-style-type: none"> • Super low profile for discreet placement • Fulfills all legal requirements (SAE J845 Class 1, CT13, ...) • Synchronized units can flash simultaneously or alternately • 5 year warranty 	<ul style="list-style-type: none"> • Voltage: 10-30 VDC • Light Source: 6 LEDs • Flash Pattern: 23 user selectable flash pattern • Approval: SAE J595 Class 1, California Title 13 • Colors: Amber, Blue, Red and White • Power Consumption: 6 Watt • Housing material: Plastic • Mounting: Screw • Connection: 8" cable with open wires 	<p>358111321 (H22895001) Amber</p> <p>358111331* (H22895021) Blue</p> <p>358111341 (H22895031) White</p> <p>358111351* (H22895041) Red</p> <p>358111361 (H22895051) Amber/White</p> <p>358111371 (H22895061) Red/Blue</p> <p>* Special order item</p>



Product image / Dimensions	Features	Technical Specifications	Part Number
----------------------------	----------	--------------------------	-------------

MS3 MINI LED LIGHTHEADS

LED

- Compact 3 LED warning strobe
- Black aluminum base for maximum heat dissipation
- Fulfills all legal requirements (SAE J845 Class 1, CT13, ...)
- Synchronized units can flash simultaneously or alternately
- 5 year warranty

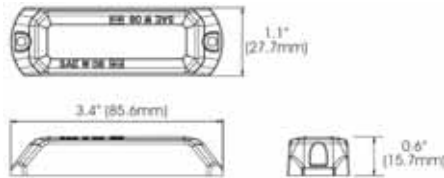

- Voltage: 10-30 VDC
- Light Source: 3 LEDs
- Flash Pattern: 12 user selectable flash pattern
- Approval: SAE J595 Class 1, California Title 13
- Colors: Amber, White
- Power Consumption: 5 Watt
- Housing material: Aluminum
- Mounting: Screw
- Connection: 4" cable with open wires

358111221 (H22891001)	Amber
358111241 (H22891031)	White

MST3 SLIM STROBE LIGHTHEADS

LED

- Super compact and low profile flasher for discreet placement
- Fulfills all legal requirements (SAE J845 Class 1, CT13, ...)
- Synchronized units can flash simultaneously or alternately
- 5 year warranty



- Voltage: 10-30 VDC
- Light Source: 3 LEDs
- Flash Pattern: 12 user selectable flash pattern
- Approval: SAE J595 Class 1, California Title 13
- Colors: Amber, Blue, Red and White
- Power Consumption: 3 Watt
- Housing material: Plastic
- Mounting: Screw
- Connection: 8" cable with open wires

358111001 (H22896001)	Amber
358111011 (H22896021)	Blue
358117131 (H22896041)	White
358117121 (H22896031)	Red

LOW PROFILE LED WARNING AND TRAFFIC STICKS

LED

- Super low profile for stealth look and minimize rear view obstruction
- Non-volatile memory recalls last flash pattern used at power up
- Reverse battery protection
- Available in amber, white, red, blue, and green
- Available as components to build your own custom color configurations
- 5 year warranty

- Light Source: 3 LEDs per lighthouse
- Warning Patterns: 27 Patterns (Warning version) / 31 Patterns (Traffic version)
- Operating Voltage: 12 - 24 VDC
- Max Power: 4 Heads = 24.4 W
- Max Power: 6 Heads = 37.2 W
- Max Power: 8 Heads = 48.7 W
- Approvals: SAE J595 Class 1(1), California Title 13(2), ECE R10
- Colors: Amber, White, Red, Blue, Green
- Connection Warning Stick: 3' (40 cm) cable / wire leads
- Connection Traffic Stick: 15' (4,5 m) cable / wire leads
- Operating Temperature: -30°C to +60°C
- IP Rating: IPX5

358111401* (H27914001)	4 Lighthoods Amber
358111411* (H27915001)	6 Lighthoods Amber
358111421* (H27916001)	8 Lighthoods Amber
358115731 (H27918101)	Single LED Pod - Amber
358115741* (H27918111)	Single LED Pod - White
358115751* (H27918121)	Single LED Pod - Red
358115761* (H27918131)	Single LED Pod - Blue
358116751 (H27919041)	6 Switch Control Panel
358114391 (H27919051)	4 Switch Control Panel

* Special order item



6 Button Control Panel with LED Display



4 Switch Control Panel

Find the right product with ease



The purpose of our online information is to provide you with more ways to efficiently and conveniently identify the latest HELLA products and obtain important information about them. No matter what you are looking for, we are sure to have the right product in our range!

- Product information
- Product videos
- 3D animations
- Configuration tools for many Applications
- Interactive applications for phones smart and tablets
- LIGHTING technology comparisons
- Adjustment recommendations

ELIVER - WORK LIGHTS and OPTICAL WARNING SYSTEMS simulator

This online tool allows you to compare the light distribution of WORK LIGHTS and flash patterns of HELLA products in a realistic environment.



www.hella.com/eliver

WORK LIGHT CONFIGURATOR

Which work lamp is the right choice for your application? The HELLA online configurator provides you with matching product recommendations, including all relevant product information.



www.hella.com/worklight-configurator

HELLA MINING

The HELLA Mining Center of Excellence was created in Australia in 2002 to design, develop and manufacture lighting products specifically for the mining industry. HELLA uses its research, engineering and logistics expertise to produce lighting products designed to meet world class standards that can be used in mining applications worldwide.

HELLA Mining products meet the needs of mining companies. The concept of "Technology with Vision" highlights the fact that we exceed the expectations of our customers by producing quality products that meet the requirements for the toughest industry on the planet in an efficient, advanced and professional manner, offering real technology with vision to future.



www.hellamining.com

MICROSITE: Find more information about HELLA Mining

MICROSITE: Find more information about HELLA MARINE:



www.hellamarine.com



HELLA MARINE

HELLA MARINE is headquartered in Auckland, New Zealand, a country with a rich maritime history, world class boat building and yacht racing success.

Combining this passion for the ocean with decades of experience in the design of LED products, HELLA MARINE lights are totally compatible and feature functional design, offering total peace of mind, safety and durability at sea. Through research and development, innovative design and the use of high quality materials, HELLA MARINE continues to establish benchmarks for extremely reliable and highly efficient products.

At present, HELLA MARINE is a world-renowned and reliable brand in navigation for its high-performance LED LIGHTING systems, available in more than 60 countries through the HELLA global network and specialized maritime distributors.



HELLA

THE LIGHTING EXPERT

OUR EXPERIENCE FOR YOUR SUCCESS



**120 YEARS
OF INNOVATION**

**BEST IN CLASS IN
LIGHTING DESIGN**



**QUALITY WITHOUT
COMPROMISE**

**CERTIFIED LIGHT
SOURCES**



**VEHICLE SPECIFIC
LIGHTING
ELECTRONICS**



The longest light tunnel in Europe has its home in Lippstadt, Germany – at HELLA. With a length of 140 meters, it's a unique tool to perform extensive tests.

TESTED QUALITY



Geometrical Measurement

A measuring projector is used to check the filament geometry – with regard to the statutory standards in accordance with IEC 60810. The filament must be dimensioned and positioned within the bulb as specified in the standard. This is the only way to achieve optimum headlight power and prevent glare to oncoming traffic.



Vibration and Shock Test

Here, vibration resistance of the bulb and the filament in particular, is tested on an electrodynamic vibration table.



Lifetime Test

Sophisticated tests are used to prove the high reliability of the HELLA bulbs over a long period.



Paint Adhesion Test

The adhesion of paint on colored glass bulbs – such as the PY21W for example – is tested in a climate chamber at different temperatures and air humidities. Optimum adhesion of glass bulb paint guarantees the prescribed amber indicator light over the whole service life period.



Light Flux Measurement

The Ulbricht sphere and goniometer are used to determine the light fluxes and luminous intensities of the HELLA bulbs. This guarantees optimum light output of the bulbs.

Compliance with World Class Standards



DOT

SAE
INTERNATIONAL®



ICA
OCP 0009 INMETRO

ARAI
Progress through Research

WVSCC

HELLA LED RETROFIT FOG LIGHT BULBS

PRODUCT RANGE

NEW!

The new LED Retrofits produce a white light similar to daylight. The optimum visibility makes driving much more comfortable and relaxed, especially at night. Durability and high functionality included, of course.

Product Video



Standard halogen lamps

HELLA LED Retrofit

**NOTICE: FOR FOG LIGHT USE ONLY
IN US/CANADA.** Check provincial and local
regulations before installing.

SIMPLY RETROFIT

The short path from Halogen to LED: With the new LED retrofits, car lighting can be upgraded to the latest LED technology. The new LED retrofits offer exceptional brightness and thanks to optimized light distribution there is more light on the road where it is needed. A longer service compared to halogen bulbs makes the LED retrofits attractive for all car drivers. The stylish look with a cool white beam gives the customers a day light effect in the night and more comfort and joy while driving. Our new portfolio offers a comprehensive range of applications, including high and low beam headlights, and fog lights and a high coverage of various vehicles.



LED FOG LIGHTS

H3 LED



H7 LED



H8/H11/H16 LED FOG



Type	LED (~ H3)	LED (~ H7)	LED FOG (~H8/H11/H16)
Voltage	12 / 24 V	12 / 24 V	12 / 24 V
Color temperature	6500K	6500K	6500K
Part Number	226971511	226971531	226971551
Packaging Unit	Set of 2	Set of 2	Set of 2

ACCESSORIES

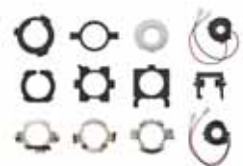





Description	LED CANBUS Adapter for LED-HL (~ H7)	LED CANBUS Adapter for LED-Fog (~ H8, H11, H16)	LED LIGHT REPAIR CANBUS for LED-HL (~ H7)	Adapter Rings KIT
Part Number	226971611	226971631	226971621	226971641
Packaging Unit	Set of 2	Set of 2	Set of 2	Assortment

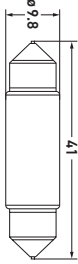

Modern light inside the car in a simple way with the new HELLA LED bulbs. The new HELLA LED Bulbs features a pleasant color temperature, with a high performance light and especially for energy efficiency and long life.

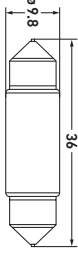
3.4 LED MINIATURE BULBS

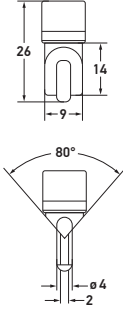
Product Image / Dimensions	Part Number	Voltage	Wattage	Base	Shape	Luminous Flux (lumens)	Kelvin	Content	Packaging	DOT	ECE	INMETRO	Features
6411 LED  	◆ 6411LED 5K	12	1 W	SV8.5-8	-	-	5000	1	B				
	◆ 6411LED 6.5K	12	1 W	SV8.5-8	-	-	6500	1	B				
REPLACES: 6411, 6413, 6451, 6475													
6418 LED  	◆ 6418LED 5K	12	1 W	SV8.5-8	-	-	5000	1	B				
	◆ 6418LED 6.5K	12	1 W	SV8.5-8	-	-	6500	1	B				
REPLACES: 6418													
921 LED  	◆ 921LED 5K	12	1 W	W2.1x9.5d	-	-	5000	2	B				
	◆ 921LED 6.5K	12	1 W	W2.1x9.5d	-	-	6500	2	B				
REPLACES: 921, 158, 168, 194, 2820, 2821, 2825, 2827, 3652, 912													

1 HEADLIGHT HALOGEN STANDARD BULBS

LOW BEAM

HIGH BEAM

* FOG LIGHT (WHERE APPLICABLE)

H1*	H2	H3*	H3C*	H4*	H7*	H8*	H8B*	H9	H9B*	H10	H11	H11B	H12
H13	H15	H16	9003	9004	9005*	9005XS	9006	9006XS	9007	862*	880*		
881*	884*	HS1	7951	9012LL	M5								

2 INDICATORS

FRONT

REAR

SIDE

7507C	7506NA	3156	3157	H21W	H6W	
7440	7440NA	158A	6411	6411	2825	5008

3 POSITION LIGHT

FRONT

REAR

3893	194	2845	7440	7443		
5007	5008	6428	6413	H5W	H6W	H10W

4 REVERSE LIGHT

7506	7440	DE3175	H21W	H6W

5 DASHBOARD

2721	007997051

6 LICENSE PLATE LIGHT

7225	7537	5007	194
7440	7443	5008	2825

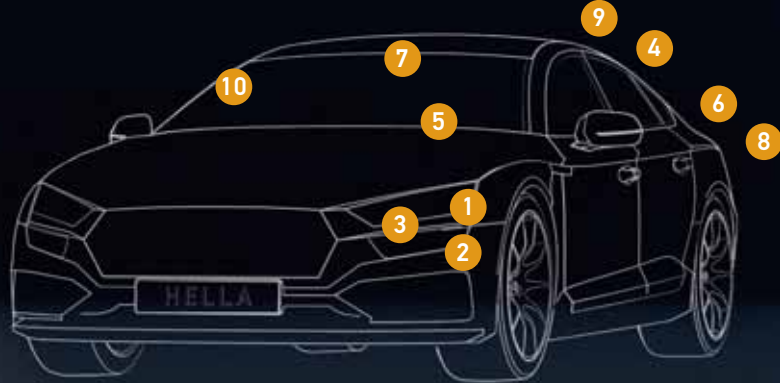

<p>1</p> <p>PERFORMANCE</p> <p>+50%</p> <table border="0"> <tr><td>H1P50TB</td><td>9004P50TB</td></tr> <tr><td>H3P50TB</td><td>9005P50TB</td></tr> <tr><td>H4P50TB</td><td>9006P50TB</td></tr> <tr><td>H7P50TB</td><td>9007P50TB</td></tr> <tr><td>H11P50TB</td><td></td></tr> <tr><td>H13P50TB</td><td></td></tr> </table>	H1P50TB	9004P50TB	H3P50TB	9005P50TB	H4P50TB	9006P50TB	H7P50TB	9007P50TB	H11P50TB		H13P50TB		<p>PERFORMANCE</p> <p>High Performance 2.0</p> <table border="0"> <tr><td>H1 2.0TB</td><td>9004 2.0TB</td></tr> <tr><td>H3 2.0TB</td><td>9003 2.0TB</td></tr> <tr><td>H7 2.0TB</td><td>9005 2.0TB</td></tr> <tr><td>H9 2.0TB</td><td>9006 2.0TB</td></tr> <tr><td>H11 2.0TB</td><td>9007 2.0TB</td></tr> <tr><td>H13 2.0TB</td><td></td></tr> </table>	H1 2.0TB	9004 2.0TB	H3 2.0TB	9003 2.0TB	H7 2.0TB	9005 2.0TB	H9 2.0TB	9006 2.0TB	H11 2.0TB	9007 2.0TB	H13 2.0TB		<p>HEAVY DUTY</p> <p>Heavy Duty</p> <table border="0"> <tr><td>H3HD</td><td>H11 24V DP</td></tr> <tr><td>H3 24V HD</td><td>198HD</td></tr> <tr><td>H4 24V HD</td><td>5637HD</td></tr> <tr><td>H1 24V DP</td><td>7510LTS</td></tr> <tr><td>H3 24V DP</td><td></td></tr> <tr><td>H4 24V DP</td><td></td></tr> <tr><td>H7 24V DP</td><td></td></tr> </table>	H3HD	H11 24V DP	H3 24V HD	198HD	H4 24V HD	5637HD	H1 24V DP	7510LTS	H3 24V DP		H4 24V DP		H7 24V DP		<p>STANDARD</p> <p>Bulbs and fuses set</p> <p>9005EMK 9006EMK</p>																																
H1P50TB	9004P50TB																																																																								
H3P50TB	9005P50TB																																																																								
H4P50TB	9006P50TB																																																																								
H7P50TB	9007P50TB																																																																								
H11P50TB																																																																									
H13P50TB																																																																									
H1 2.0TB	9004 2.0TB																																																																								
H3 2.0TB	9003 2.0TB																																																																								
H7 2.0TB	9005 2.0TB																																																																								
H9 2.0TB	9006 2.0TB																																																																								
H11 2.0TB	9007 2.0TB																																																																								
H13 2.0TB																																																																									
H3HD	H11 24V DP																																																																								
H3 24V HD	198HD																																																																								
H4 24V HD	5637HD																																																																								
H1 24V DP	7510LTS																																																																								
H3 24V DP																																																																									
H4 24V DP																																																																									
H7 24V DP																																																																									
<p>LONG LIFE</p> <p>Long Life</p> <table border="0"> <tr><td>H1LL</td><td>9003LL</td></tr> <tr><td>H3LL</td><td>9004LL</td></tr> <tr><td>H4LL</td><td>9005LL</td></tr> <tr><td>H7LL</td><td>9006LL</td></tr> <tr><td>H11LL</td><td>9007LL</td></tr> <tr><td>H13LL</td><td></td></tr> </table> <p>LED</p> <p>Fog light set</p> <table border="0"> <tr><td>H3</td><td>226971511</td></tr> <tr><td>H7</td><td>226971531</td></tr> <tr><td>H8, H11, H16</td><td>226971551</td></tr> </table>	H1LL	9003LL	H3LL	9004LL	H4LL	9005LL	H7LL	9006LL	H11LL	9007LL	H13LL		H3	226971511	H7	226971531	H8, H11, H16	226971551	<p>DESIGN</p> <p>OPTILUX Extreme White XB</p> <table border="0"> <tr><td>880</td><td>H10</td></tr> <tr><td>881</td><td>H11</td></tr> <tr><td>893</td><td>H13/9008</td></tr> <tr><td>H1</td><td>H16/9009</td></tr> <tr><td>H3</td><td>9004 / HB1</td></tr> <tr><td>H3C</td><td>9005 / HB3</td></tr> <tr><td>H4/9003</td><td>9005XS</td></tr> <tr><td>H7</td><td>9006 / HB4</td></tr> <tr><td>H8</td><td>9006XS</td></tr> <tr><td>H9</td><td>9007 / HB5</td></tr> </table>	880	H10	881	H11	893	H13/9008	H1	H16/9009	H3	9004 / HB1	H3C	9005 / HB3	H4/9003	9005XS	H7	9006 / HB4	H8	9006XS	H9	9007 / HB5	<p>DESIGN</p> <p>OPTILUX Extreme Yellow XY</p> <table border="0"> <tr><td>880</td><td>H9</td></tr> <tr><td>881</td><td>H10</td></tr> <tr><td>893</td><td>H11</td></tr> <tr><td>894</td><td>H13/9008</td></tr> <tr><td>H1</td><td>H16/9009</td></tr> <tr><td>H3</td><td>9004 / HB1</td></tr> <tr><td>H3C</td><td>9005 / HB3</td></tr> <tr><td>H4/9003</td><td>9006 / HB4</td></tr> <tr><td>H7</td><td>9006XS</td></tr> <tr><td>H8</td><td>9007 / HB5</td></tr> </table>	880	H9	881	H10	893	H11	894	H13/9008	H1	H16/9009	H3	9004 / HB1	H3C	9005 / HB3	H4/9003	9006 / HB4	H7	9006XS	H8	9007 / HB5	<p>HIGH WATTAGE</p> <p>High Wattage</p> <table border="0"> <tr><td>H1 100WTB</td></tr> <tr><td>H3 100WTB</td></tr> <tr><td>H3 130WTB</td></tr> <tr><td>9004 100/80WTB</td></tr> <tr><td>9005 100WTB</td></tr> <tr><td>9006 80WTB</td></tr> <tr><td>9007 100/80WTB</td></tr> <tr><td>H4 100/55WTB</td></tr> <tr><td>H4 100/80WTB</td></tr> <tr><td>H4 130/90WTB</td></tr> <tr><td>H7 100WTB</td></tr> <tr><td>H11 24V DP</td></tr> </table>	H1 100WTB	H3 100WTB	H3 130WTB	9004 100/80WTB	9005 100WTB	9006 80WTB	9007 100/80WTB	H4 100/55WTB	H4 100/80WTB	H4 130/90WTB	H7 100WTB	H11 24V DP
H1LL	9003LL																																																																								
H3LL	9004LL																																																																								
H4LL	9005LL																																																																								
H7LL	9006LL																																																																								
H11LL	9007LL																																																																								
H13LL																																																																									
H3	226971511																																																																								
H7	226971531																																																																								
H8, H11, H16	226971551																																																																								
880	H10																																																																								
881	H11																																																																								
893	H13/9008																																																																								
H1	H16/9009																																																																								
H3	9004 / HB1																																																																								
H3C	9005 / HB3																																																																								
H4/9003	9005XS																																																																								
H7	9006 / HB4																																																																								
H8	9006XS																																																																								
H9	9007 / HB5																																																																								
880	H9																																																																								
881	H10																																																																								
893	H11																																																																								
894	H13/9008																																																																								
H1	H16/9009																																																																								
H3	9004 / HB1																																																																								
H3C	9005 / HB3																																																																								
H4/9003	9006 / HB4																																																																								
H7	9006XS																																																																								
H8	9007 / HB5																																																																								
H1 100WTB																																																																									
H3 100WTB																																																																									
H3 130WTB																																																																									
9004 100/80WTB																																																																									
9005 100WTB																																																																									
9006 80WTB																																																																									
9007 100/80WTB																																																																									
H4 100/55WTB																																																																									
H4 100/80WTB																																																																									
H4 130/90WTB																																																																									
H7 100WTB																																																																									
H11 24V DP																																																																									



10 **GLOVE BOX LIGHT**

2825 W5W	7440 C5W	5007 R5W

9 **TRUNK LIGHT**

5007 R5W	7440 C5W	6411 T0W	6411 LED

7 **INTERIOR LIGHT**

7440 H6W	7443 R5W	5008 R10W	6413 C5W	2825 W5W	6428 M Bulb	921 LED	6411 LED	6418 LED

8 **STOP LIGHT**

7537 P21/5W	7225 P21/4W	7506 P21W	7440 W21W	7443 W21/5W	5007 R5W



PRODUCT RANGE

COMPLIES WITH ECE, SAE AND INMETRO STANDARD*

*Where applicable



STANDARD
Standard Halogen Bulbs - 12 V

862	898	H3 35W	H15
880	899	H4	H16
881	9003	H4 35/35W	HS1
884	9004	H4 45/45W	H10W
885	9005	H4 P45T	H20W
886	9005XS	H7	H21W
887	9006	H8	H5W
888	9006XS	◆ H8B	H6W
889	9007	H9	◆ M5 35/35W
890	9009S	◆ H9B	◆ M5 35/35W1
891	HIR2	H10 (9145)	◆ M5 25/25W
892	H1	H11	◆ M5 25/25W1
893	H2	H11B	◆ M5 18/18W
894	H3	H12 (9055)	◆ M5 35/35W3
896	H3C	H13	◆ M5 25/25W3

Standard Halogen Bulbs - 24 V

H1 24V	H7 24V
H3 24V	H11 24V
H4 24V	H21W 24V

STANDARD
Standard Halogen Bulbs Blister Pack - 12 V



Double Blister Pack	Single Blister Pack
9003TB, 9004TB, 9005TB, 9006TB, 9007TB, H1TB, H10TB, H11TB, H13TB, H3TB, H3 35WTB, H4TB, H4 35/35WTB, H4 45/45WTB, H4 P45TTB, H7TB, H8TB, H9TB, HS1TB	9003SB, 9004SB, 9005SB, 9006SB, 9007SB, H1SB, H10SB, H11SB, H13SB, H3SB, H3 35WSB, H4SB, H4 35/35WSB, H4 45/45WSB, H4 P45TSB, H7SB, H8SB, H9SB, HS1SB, H16SB
◆ M5 35/35WTB	◆ M5 35/35WSB

◆ **Standard Halogen Bulbs Blister Pack - 24 V**

Double Blister Pack	Single Blister Pack
H1 24VBT	H1 24VSB
H3 24VBT	H3 24VSB
H4 24VBT	H4 24VSB
H7 24VBT	H7 24VSB
H9 24VBT	H9 24VSB
H11 24VBT	H11 24VSB



STANDARD
Miniature Bulbs - (Box - Multiple voltages)

17	194R	3157NA	6411	7507
1003	198HD	3457	6413	7507C
1004	199	3457NA	6418	7511
1034	2057	3496	6423	7528
1034A	2057NA	3497	6424	7533
1034NA	2357	3652	6428	7534
1073	2357NA	37	6429	7537
1141	2396	3757A	6430	7951
1141 24V	2397	3796	6438	7951 55/50W
1156	24	3797	6451	7952
1156NA	24NA	3799	6453	89
1157	265	3893	6475	90
1157A	2721	3898	6476	912
1157NA	2741	3899	6480	921
1176	2722	3930	660	921NA
1176A	2723	400	67	93
1224	2741	5007	7225	9507
1308	2820	5008	7240	97
1445	2821	51	73	A3603
158	2825	53	74	A3625
158A	2825BL	57	7440	DE3021
168	2840	5627	7440A	DE3022
1683	2841	5637	7440NA	DE3175
1816	2845	5637HD	7441	DE3425
1891	2827NA	6235	7443	JC5
1893	3047	6245	7443A	JC10
1895	3047LL	6260	7443NA	JC20
194	3057	63	7506	PSX24W
194NA	3156	631	7506A	
194B	3157	635	7506NA	

STANDARD
Miniature Bulbs Blister Pack

Double Blister Pack	Single Blister Pack
7506TB	168TB
1034TB	73TB
2825TB	53TB
7528TB	1157TB
921TB	7507CTB
7443TB	1141TB
158TB	7506ATB
5007TB	6418TB
67TB	DE3021TB
3898TB	7225TB
3157TB	2827NATB
5008TB	2821TB
5637TB	7507CTB
3893TB	1141TB
7440TB	7506ATB
7507TB	6418TB
DE3175TB	DE3021TB
6411TB	7225TB
2721TB	2827NATB
	2821TB

◆ **Miniature Bulbs, Blister Pack - 24 V**

Double Blister Pack	Single Blister Pack
1141 24VBT	6429TB
2741TB	7510LTSTB
2841TB	7511TB
2845TB	7534TB
3797TB	7537TB
3930TB	7952TB
5627TB	9507TB
6423TB	
	1141 24VSB
	2845SB
	5627SB
	7511SB
	7537SB



STANDARD
Xenon Lamps (HID)

D1S 4300 K
D2S 4300 K
D2R 4300 K
D3S 4300 K
D4S 4300 K



PERFORMANCE
Xenon Lamps +30 (HID)

D1S 5000 K
D2S 5000 K
D2R 5000 K

LED
LED Bulbs



5000 K	6500 K
6411LED 5K	6411LED 6.5K
6418LED 5K	6418LED 6.5K
921LED 5K	921LED 6.5K

LONG LIFE
Long Life 12 V and 24 V

9003LL	H1LL
9004LL	H4 24V LL
9005LL	H7 24V LL
9006LL	H7LL
9007LL	H11LL
9012LL	

Long Life Miniature Bulbs

1003LL	3157LL
1141LL	7440LL
1156LL	7443LL
1157LL	
2057LL	
2057NALL	
2357LL	
3047LL	



A: Amber glass



NA: Natural Amber glass

The "Amber Crystal" bulbs have an amber tint on their crystal.
The "Natural amber glass" bulbs are made with a mixture of minerals that provide the amber color in the crystal.

Part No. Nomenclature

- A: Amber glass
- NA: Natural amber glass
- BL: Blue crystal
- R: Red crystal
- C: Clear glass, (transparent)
- CB: Light blue glass
- TCB: Light blue glass - two pieces
- P50: 50% more light than standard HELLA bulbs
- HD: Heavy equipment
- YL: Yellow glass
- TB: Blister Pack double
- ◆: New product



PERFORMANCE

+50 - 12V

Box	Double Blister Pack
H1P50	H1P50TB
H4P50	H3P50TB
H3P50	H4P50TB
H7P50	H7P50TB
H11P50	H11P50TB
H13P50	H13P50TB
9004P50	9004P50TB
9005P50	9005P50TB
9006P50	9006P50TB
9007P50	9007P50TB

HIGH WATTAGE

High Wattage 12 V

Single box	Double Blister Pack	Single Blister Pack
H1 100W	H1 100WTB	H4 100/80WSB
H1 130W	H3 100WTB	9007 100/80WSB
H2 100W	H3 130WTB	9004 100/80WSB
H3 100W	H4 100/55WTB	9006 80WSB
H3 130W	H4 100/80WTB	9005 100WSB
H3 24V 100W	H4 130/90WTB	
H4 100/55W	H7 100WTB	
H4 100/80W	9004 100/80WTB	
H4 130/90W	9005 100WTB	
H4 24V 100/90W	9006 80WTB	
H7 100W	9007 100/80WTB	
H7 70W		
9004 100/80W	◆ H3 24V 100WTB	
9005 100W	◆ H4 24V 100/90WTB	
9006 80W		
9007 100/80W		

Notice that due to the high consumption it can be generated on heating in the wiring of the headlight.



DOUBLE POWER

HEAVY DUTY

Heavy Duty - 12 V and 24 V

Halogen	Miniature
H3HD	198HD
H3 24V HD	5637HD
H4 24V HD	7510LTS
H1 24V DP	◆ Single Blister Pack
H3 24V DP	H1 24V DPSB
H4 24V DP	H3 24V HDSB
H7 24V DP	H3 24V DPSB
H11 24V DP	H4 24V HDSB
	H4 24V DPSB
	H7 24V DPSB
	H11 24V DPSB

◆ Double Blister Pack
H3 24V HDTB
H4 24V HDTB

PERFORMANCE

High Performance 2.0

Double Blister Pack	
H1 2.0TB	9004 2.0TB
H3 2.0TB	9003 2.0TB
H7 2.0TB	9005 2.0TB
H9 2.0TB	9006 2.0TB
H11 2.0TB	9007 2.0TB
H13 2.0TB	

LED

LED Fog light set

◆ H3 LED	226971511
◆ H7 LED	226971531
◆ H8, H11, H16 LED	226971551

STANDARD

Emergency Set

Halogen bulb, miniature bulbs and fuses	
9005EMK	
9006EMK	

STANDARD

Motorcycle Bulbs

194
635
660
2721
3652
7441
7951
7952
194NA
7440LL
7440NA
H11
H11LL
H11P50
H21W
H6W
H9



Double Plastic Case

DESIGN

Optilux Extreme White XB - 12V

880	32 W	H71071212
881	32 W	H71071222
893	37.5 W	H71071232
9004	65/45 W	H71071392
9005	65 W	H71071402
9005	65 W	H71071412
9005	100 W	H71071422
9006	55 W	H71071432
9006	55 W	H71071442
9006	80 W	H71071452
9007	65/55 W	H71071472
H1	55 W	H71071242
H10	65 W	H71071012
H10	42 W	H71071252
H11	80 W	H71071032
H11	55 W	H71071262
H13	100/80 W	H71071052
H13	60/55 W	H71071272
H16	35 W	H71071282
H2	100 W	H71070227
H3	100 W	H71070181
H3	55 W	H71071312
H3C	55 W	H71071322
H3C	80 W	H71071332
H4	100/80 W	H71070201
H4	60/55 W	H71071352
H7	100 W	H71070307
H7	55 W	H71071362
H8	55 W	H71070772
H8	35 W	H71071372
H9	100 W	H71070792
H9	65 W	H71071382
HB1	100/80 W	H71070327
HB3	100 W	H71070347
HB4	80 W	H71070367
HB5	100/80 W	H71070387

Double Plastic Case

DESIGN

Optilux Extreme Yellow XY - 12V

880	27 W	H71071172
881	27 W	H71071182
893	37.5 W	H71071192
9006	55 W	H71071462
H1	55 W	H71070642
H10	42 W	H71071112
H11	55 W	H71071132
H13	60/55 W	H71071152
H16	35 W	H71071302
H3	55 W	H71070662
H3C	55 W	H71071342
H4	60/55 W	H71070682
H7	55 W	H71070702
H8	35 W	H71071072
H9	65 W	H71071092
HB1	65/45 W	H71070562
HB3	65 W	H71070582
HB4	55 W	H71070602
HB5	60/55 W	H71070622

HELLA HALOGEN BULBS

PRODUCT RANGE



Standard



+50



Long Life

STANDARD

HELLA standard halogen bulbs provide a quality of original equipment manufacturer and great value for your money. The optimal balance between performance and service life. With SAE / ECE and INMETRO approval (when applicable).

- Halogen and Miniature **See page 112**
- Emergency Set **See page 133**
- LED Miniature bulbs **See page 106**
- Bulbs for Motorcycles **See page 148**
- Halogen 12 V Blister Pack **See page 138**
- Miniature Blister Pack **See page 139**
- Halogen 24 V Blister Pack **See page 140**

PERFORMANCE

Our bulbs are establishing new reference points for halogen lighting, making driving safer and more pleasant, providing a beam of light with greater intensity compared to HELLA Standard bulbs. The opaque silver lid offers an elegant look in the clear glass headlights

- High Performance 2.0 **See page 142**
- +50 **See page 143**

LONG LIFE

HELLA Long Life halogen bulbs have a long service life up to 2 times longer than HELLA standard bulbs and are more environmentally friendly, as they do not have to be replaced frequently. Provides an optimal value for your money and the best selection for frequent travelers.

See page 141



Clear Blue

Xtreme Yellow

High Performance 2.0

OPTILUX Extreme White XB

HEAVY DUTY / DOUBLE POWER

Double power of 24V produces the light by means of a single filament. Heavy duty bulbs offer more power, more safety, without dazzling traffic.

The double power reduces costs by increasing the life of up to 100%.

- Heavy Duty See page 145
- Double Power See page 145

HIGH WATTAGE

It offers more light, with double brightness compared to HELLA standard halogen bulbs and greater luminous efficiency, its Special filament guarantees safety and relaxed driving in off-road conditions.

Note: Take into account that due to the high wattage it can generate on heating the wiring of the headlight.

See page 144







DESIGN

Our design bulbs meet special requirements regarding design and safety. The xenon-like effect makes whiter light the correct alternative for design-oriented drivers. Our range of products:

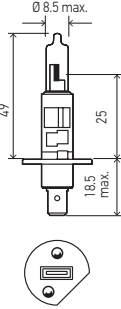
OPTILUX

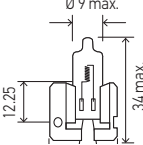
- Extreme Yellow XY See page 146
- Extreme White XB See page 147

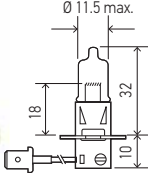

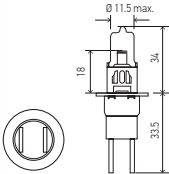
Product Image / Dimensions	Part Number	Voltage	Wattage	Base	Shape	Luminous Flux (lumens)	Kelvin	Content	Packaging	DOT	ECE	INMETRO	Features	
H1  	H1	12	55 W	P14.5s	T2.5	1550		1	C	■	■	■	Standard	
	H1 24V	24	70 W	P14.5s	T2.5	1900		1	C	■	■	■	Standard	
	H1P50	12	55 W	P14.5s	T2.5	1700		1	C	■	■	■	+ 50	
	◆ H1P50TB	12	55 W	P14.5s	T2.5	1700		2	B	■	■	■	+ 50	
	◆ H1 24V DP	24	70 W	P14.5s	T2.5	1900		1	C		■	■	Double Power	
	H1 100W	12	100 W	P14.5s	T2.5	1850		1	C				High Wattage	
	H1 130W	12	130 W	P14.5s	T2.5	2400		1	C				High Wattage	
	◆ H1 2.0TB	12	55 W	P14.5s	T2.5	1550	3600	2	B	■	■	■	High Performance 2.0	
	H1LL	12	55 W	P14.5s	T2.5	1550		1	C	■	■	■	Long Life	
	H1 YL	12	55 W	P14.5s	T2.5	1550	2900	2	B				Xtreme Yellow	
	H71070227*	12	100 W	P14.5s	T2.5			2	P				Extreme White XB	
	H71071242*	12	55 W	P14.5s	T2.5			2	P				Extreme White XB	
	H71070642*	12	55 W	P14.5s	T2.5			2	P				Extreme Yellow XY	
	◆ H1TB	12	55 W	P14.5s	T2.5	1550		2	B	■	■	■	Standard	
	◆ H1SB	12	55 W	P14.5s	T2.5	1550		1	B	■	■	■	Standard	
	◆ H1 100WTB	12	100 W	P14.5s	T2.5	1850		2	B				High Wattage	
	◆ H1 24VSB	24	70 W	P14.5s	T2.5			1	B		■	■	Standard	
	◆ H1 24VTB	24	70 W	P14.5s	T2.5			2	B		■	■	Standard	
◆ H1 24V DPSB	24	70 W	P14.5s	T2.5			1	B		■	■	Double Power		
LOW BEAM, HIGH BEAM, FOG LIGHT (WHERE APPLICABLE)														
H2  	H2	12	55 W	X511	T3			1	C			■	Standard	
	H2 100W	12	100 W	X511	T3			1	C				High Wattage	
LOW BEAM, HIGH BEAM, FOG LIGHT (WHERE APPLICABLE)														
H3    <p>H3 BULLET</p>	H3	12	55 W	PK22s	T3.25	1450		1	C	■	■	■	Standard	
	H3 BULLET	12	55 W	PK22s	T3.25	1450		1	C					Standard
	H3 35W	12	35 W	PK22s	T3.25	750		1	C					Standard
	H3 24V	24	70 W	PK22s	T3.25	1750		1	C		■	■		Standard
	H3P50	12	55 W	PK22s	T3.25	1600		1	C					+ 50
	◆ H3P50TB	12	55 W	PK22s	T3.25	1600		2	B					+ 50
	H3XE-100CB	12	100 W	PK22s	T3.25	1600	3600	1	C					Clear Blue/High W
	H3 24V DP	24	70 W	PK22s	T3.25			1	C		■	■		Double Power
	H3 24V HD	24	70 W	PK22s	T3.25	1750		1	C		■	■		Heavy Duty
	◆ H3HD	12	55 W	PK22s	T3.25	1450		1	C	■	■	■		Heavy Duty
	H3 100W	12	100W	PK22s	T3.25	1850		1	C					High Wattage
	H3 130W	12	130 W	PK22s	T3.25	2600		1	C					High Wattage
	H3 24V 100W	24	100 W	PK22s	T3.25	2500		1	C					High Wattage
	◆ H3 100WTB	12	100 W	PK22s	T3.25	1850		2	B					High Wattage
	◆ H3 130WTB	12	130 W	PK22s	T3.25	2600		2	B					High Wattage
	◆ H3 2.0TB	12	55 W	PK22s	T3.25	1450	3600	2	B	■	■	■		High Performance 2.0
	H3 YL	12	55 W	PK22s	T3.25	1450	2900	2	B					Xtreme Yellow
	H71070181*	12	100 W	PK22s	T3.25			2	P					Extreme White XB
	H71071312*	12	55 W	PK22s	T3.25			2	P					Extreme White XB
	H71070662*	12	55 W	PK22s	T3.25			2	P					Extreme Yellow XY
	◆ H3TB	12	55 W	PK22s	T3.25	1450		2	B	■	■	■		Standard
	◆ H3 35WTB	12	35 W	PK22s	T3.25	750		2	B					Standard
	◆ H3SB	12	55 W	PK22s	T3.25	1450		1	B	■	■	■		Standard
	◆ H3 35WSB	12	35 W	PK22s	T3.25	750		1	B					Standard
	◆ H3 24V DPSB	24	70 W	PK22s	T3.25			1	B		■	■		Double Power
	◆ H3 24V HDSB	24	70 W	PK22s	T3.25			1	B		■	■		Heavy Duty
	◆ H3 24VSB	24	70 W	PK22s	T3.25			1	B		■	■		Standard
	◆ H3 24V 100WTB	24	100 W	PK22s	T3.25			2	B					High Wattage
◆ H3 24V HDTB	24	70 W	PK22s	T3.25			2	B		■	■		Heavy Duty	
◆ H3 24VTB	24	70 W	PK22s	T3.25			2	B		■	■		Standard	
H3C  	H71071322*	12	55 W	P22d	T3.25			2	P				Extreme White XB	
	H71071332*	12	80 W	P22d	T3.25			2	P				Extreme White XB	
	H71071342*	12	55 W	P22d	T3.25			2	P				Extreme Yellow XY	
LOW BEAM, HIGH BEAM, FOG LIGHT (WHERE APPLICABLE)														

C = Box B = Blister Pack P = Plastic Case
 * = OPTILUX Product Range ◆ = New Product

Measures in millimeters









Product Image / Dimensions	Part Number	Voltage	Wattage	Base	Shape	Luminous Flux (lumens)	Kelvin	Content	Packaging	DOT	ECE	INMETRO	Features
H4 	H4	12	60/55 W	P43t	T4.625	1650/1000	3200	1	C		■	■	Standard
	H4 24V	24	75/70 W	P43t	T4.625	1900/1200		1	C		■	■	Standard
	H4 35/35W	12	35/35 W	P43t	T4.625	825/525		1	C				Standard
	H4 45/45W	12	45/45 W	P43t	T4.625			1	C				Standard
	H4 P45T	12	60/55 W	P45t	T4.625	1650/1000		1	C				Standard
	H4P50	12	60/55 W	P43t	T4.625	1815/1100		1	C		■	■	+ 50
	◆ H4P50TB	12	60/55 W	P43t	T4.625	1815/1100		2	B		■	■	+ 50
	H4XE-CB	12	60/55 W	P43t	T4.625	1650/1000	3600	1	C				Clear Blue
	H4XE-100CB	12	100/80 W	P43t	T4.625	2000/1350	3600	1	C				Clear Blue/High W
	◆ H4 24V DP	24	75/70 W	P43t	T4.625	1900/1200		1	C		■	■	Double Power
	H4 24V HD	24	75/70 W	P43t	T4.625	1900/1200		1	C		■	■	Heavy Duty
	H4 100/55W	12	100/55 W	P43t	T4.625	2400/1000		1	C				High Wattage
	H4 100/80W	12	100/80 W	P43t	T4.625			1	C				High Wattage
	H4 130/90W	12	130/90 W	P43t	T4.625	3200/1600		1	C				High Wattage
	H4 24V 100/90W	24	100/90 W	P43t	T4.625			1	C				High Wattage
	◆ H4 100/55WTB	12	100/55 W	P43t	T4.625	2400/1000		2	B				High Wattage
	◆ H4 100/80WTB	12	100/80 W	P43t	T4.625			2	B				High Wattage
	◆ H4 130/90WTB	12	130/90 W	P43t	T4.625	3200/1600		2	B				High Wattage
	◆ H4 100/80WSB	12	100/80 W	P43t	T4.625			1	B				High Wattage
	◆ H4 24V LL	24	75/70 W	P43t	T4.625	1900/1200		1	C				Long Life
	H4 YL	12	60/55 W	P43t	T4.625	1650/1000	2800	2	P				Xtreme Yellow
	H71070201*	12	100/80 W	P43t	T4.625			2	P				Extreme White XB
	H71071352*	12	60/55 W	P43t	T4.625			2	P				Extreme White XB
	H71070682*	12	60/55 W	P43t	T4.625			2	P				Extreme Yellow XY
	◆ H4TB	12	60/55 W	P43t	T4.625	1650/1000	3200	2	B		■	■	Standard
	◆ H4 35/35WTB	12	35 /35 W	P43t	T4.625			2	B				Standard
	◆ H4 45/45WTB	12	45 /45 W	P43t	T4.625			2	B				Standard
	◆ H4 P45TTB	12	60/55 W	P45t	T4.625			2	B				Standard
	◆ H4SB	12	60/55 W	P43t	T4.625	1650/1000	3200	1	B		■	■	Standard
	◆ H4 35/35WSB	12	35 /35 W	P43t	T4.625			1	B				Standard
◆ H4 45/45WSB	12	45 /45 W	P43t	T4.625			1	B				Standard	
◆ H4 P45TSB	12	60/55 W	P45t	T4.625	1650/1000		1	B				Standard	
◆ H4 24V 100/90WTB	24	100/90 W	P43t	T4.625			2	B				High Wattage	
◆ H4 24V HDTB	24	75/70 W	P43t	T4.625			2	B		■	■	Heavy Duty	
◆ H4 24VTB	24	75/70 W	P43t	T4.625			2	B		■	■	Standard	
◆ H4 24V DPSB	24	75/70 W	P43t	T4.625			1	B		■	■	Double Power	
◆ H4 24V HDSB	24	75/70 W	P43t	T4.625			1	B		■	■	Heavy Duty	
◆ H4 24VSB	24	75/70 W	P43t	T4.625			1	B		■	■	Standard	

LOW BEAM, HIGH BEAM, FOG LIGHT (WHERE APPLICABLE)

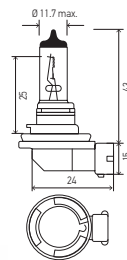
H7 	H7	12	55 W	PX26d	T4.625	1350		1	C	■	■	■	Standard
	H7 24V	24	70 W	PX26d	T4.625	1750		1	C		■	■	Standard
	H7P50	12	55 W	PX26d	T4.625	1560		1	C	■	■	■	+ 50
	◆ H7P50TB	12	55 W	PX26d	T4.625	1560		2	B	■	■	■	+ 50
	◆ H7 24V DP	24	70 W	PX26d	T4.625			1	C		■	■	Double Power
	H7 70W	12	70 W	PX26d	T4.625	1800		1	C				High Wattage
	H7 100W	12	100 W	PX26d	T4.625	2000		1	C				High Wattage
	◆ H7 100WTB	12	100 W	PX26d	T4.625	2000		2	B				High Wattage
	◆ H7 2.0TB	12	55 W	PX26d	T4.625	1500		2	P	■	■	■	High Performance 2.0
	H7 24V LL	24	70 W	PX26d	T4.625	1750		1	C		■	■	Long Life
	H7LL	12	55 W	PX26d	T4.625	1500	3700	1	C	■	■	■	Long Life
	H7 YL	12	55 W	PX26d	T4.625	1500		2	P				Xtreme Yellow
	H71070307*	12	100 W	PX26d	T4.625			2	P				Extreme White XB
	H71071362*	12	55 W	PX26d	T4.625			2	P				Extreme White XB
	H71070702*	12	55 W	PX26d	T4.625			2	P				Extreme Yellow XY
	◆ H7TB	12	55 W	PX26d	T4.625	1350		2	B	■	■	■	Standard
	◆ H7SB	12	55 W	PX26d	T4.625	1350		1	B	■	■	■	Standard
◆ H7 24VSB	24	70 W	PX26d	T4.625			1	B		■	■	Standard	
◆ H7 24VTB	24	70 W	PX26d	T4.625			2	B		■	■	Standard	
◆ H7 24V DPSB	24	70 W	PX26d	T4.625			1	B		■	■	Double Power	

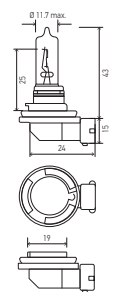
LOW BEAM, HIGH BEAM, FOG LIGHT (WHERE APPLICABLE)

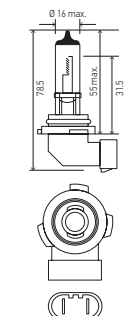

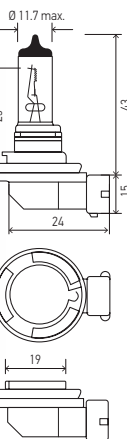

Product Image / Dimensions	Part Number	Voltage	Wattage	Base	Shape	Luminous Flux (lumens)	Kelvin	Content	Packaging	DOT	ECE	INMETRO	Features	
H8   	H8	12	35 W	PGJ19-1	T4	800		1	C	■	■		Standard	
	H71070772*	12	55 W	PGJ19-1	T4			2	P				Extreme White XB	
	H71071072*	12	35 W	PGJ19-1	T4			2	P				Extreme Yellow XY	
	H71071372*	12	35 W	PGJ19-1	T4			2	P				Extreme White XB	
	◆ H8TB	12	35 W	PGJ19-1	T4	800		2	B	■	■		Standard	
	◆ H8SB	12	35 W	PGJ19-1	T4	800		1	B	■	■		Standard	
	◆ H8B	12	35 W	PGJ19-1	T4	800		1	C		■		Standard	
	LOW BEAM, HIGH BEAM, FOG LIGHT (WHERE APPLICABLE)													
	H9   	H9	12	65 W	PGJ19-5	T4	2100		1	C	■	■		Standard
		H9 2.0TB	12	65 W	PGJ19-5	T4	2100	3700	2	P	■	■		High Performance 2.0
◆ H71070792*		12	100 W	PGJ19-5	T4			2	P				Extreme White XB	
H71071092*		12	65 W	PGJ19-5	T4			2	P				Extreme Yellow XY	
H71071382*		12	65 W	PGJ19-5	T4			2	P				Extreme White XB	
◆ H9TB		12	65 W	PGJ19-5	T4	2100		2	B	■	■		Standard	
◆ H9SB		12	65 W	PGJ19-5	T4	2100		1	B				Standard	
◆ H9 24VSB		24	80 W	PGJ19-5	T4			1	B				Standard	
◆ H9 24VTB		24	80 W	PGJ19-5	T4			2	B				Standard	
◆ H9B		12	65 W	PGJ19-5	T4	2100		1	C		■		Standard	
HIGH BEAM, WORK LIGHT														
H10  	H10	12	45 W	PY20d	T4	850		1	C		■		Standard	
	H71071012*	12	65 W	PY20d	T4			2	P				Extreme White XB	
	H71071112*	12	42 W	PY20d	T4			2	P				Extreme Yellow XY	
	H71071252*	12	42 W	PY20d	T4			2	P				Extreme White XB	
	◆ H10TB	12	45 W	PY20d	T4	850		2	B		■		Standard	
	◆ H10SB	12	45 W	PY20d	T4	850		1	B		■		Standard	
	LOW BEAM													
H11  	H11	12	55 W	PGJ19-2	T4	1350		1	C	■	■		Standard	
	H11 24V	24	70 W	PGJ19-2	T4	1600		1	C		■		Standard	
	H11P50	12	55 W	PGJ19-2	T4	1450		1	C	■	■		+ 50	
	◆ H11P50TB	12	55 W	PGJ19-2	T4	1450		2	B				+ 50	
	H11XE-CB	12	55 W	PGJ19-2	T4	1350	3600	1	C				Clear Blue	
	◆ H11 24V DP	24	70 W	PGJ19-2	T4			1	C		■		Double Power	
	◆ H11 2.0TB	12	55 W	PGJ19-2	T4	1350	3700	2	P	■	■		High Performance 2.0	
	H11LL	12	55 W	PGJ19-2	T4	1350		1	C	■	■		Long Life	
	H11 YL	12	55 W	PGJ19-2	T4	1450	3000	2	B				Xtreme Yellow	
	H71071032*	12	80 W	PGJ19-2	T4			2	P				Extreme White XB	
	H71071132*	12	55 W	PGJ19-2	T4			2	P				Extreme Yellow XY	
	H71071262*	12	55 W	PGJ19-2	T4			2	P				Extreme White XB	
	◆ H11TB	12	55 W	PGJ19-2	T4	1350		2	B	■	■		Standard	
	◆ H11SB	12	55 W	PGJ19-2	T4	1350		1	B	■	■		Standard	
	◆ H11 24V DPSB	24	70 W	PGJ19-2	T4			1	B		■		Double Power	
◆ H11 24VSB	24	70 W	PGJ19-2	T4			1	B		■		Standard		
◆ H11 24VTB	24	70 W	PGJ19-2	T4			2	B		■		Standard		
LOW BEAM														

C = Box B = Blister Pack P = Plastic Case
 * = OPTILUX Product Range ◆ = New Product

Measures in millimeters

Product Image / Dimensions	Part Number	Voltage	Wattage	Base	Shape	Luminous Flux (lumens)	Kelvin	Content	Packaging	DOT	ECE	INMETRO	Features
H11B 	H11B	12	55 W	PGJY192	T3.25	1345	3100	1	C	■	■		Standard
	LOW BEAM, HIGH BEAM, FOG LIGHT (WHERE APPLICABLE)												
H12 	H12	12	55 W	PZ20d	T4	1050		1	C		■		Standard
	LOW BEAM, HIGH BEAM, FOG LIGHT (WHERE APPLICABLE)												
H13 9008 	H13	12	60/55 W	P26.4t	T4	1700/1100		1	C	■	■		Standard
	H13P50	12	60/55 W	P26.4t	T4	1650/1100		1	C	■	■		+ 50
	H13P50TB	12	60/55 W	P26.4t	T4	1650/1100		2	B	■	■		+ 50
	H13 2.0TB	12	60/55 W	P26.4t	T4	1700/1100	3700	2	P	■	■		High Performance 2.0
	H13 YL	12	60/55 W	P26.4t	T4	1700/1100	3100	2	B				Xtreme Yellow
	H71071052*	12	100/80 W	P26.4t	T4			2	P				Extreme White XB
	H71071272*	12	60/55 W	P26.4t	T4			2	P				Extreme White XB
	H71071152*	12	60/55 W	P26.4t	T4			2	P				Extreme Yellow XY
	H13TB	12	60/55 W	P26.4t	T4	1700/1100		2	B	■	■		Standard
	H13SB*	12	60/55 W	P26.4t	T4	1700/1100		1	B	■	■		Standard
LOW BEAM, HIGH BEAM, FOG LIGHT (WHERE APPLICABLE)													
H15 	H15	12	15/55 W	PGJ23t-1	T4	1330	3100	1	C	■	■		Standard
	FOG LIGHT												
H16 	H16	12	19 W	PGJ19-3	T4		3700	1	C		■		Standard
	H16SB	12	19 W	PGJ19-3	T4		3700	1	B				Standard
FOG LIGHT													
HS1 	HS1	12	35/35 W	PX43t	T4.625			1	C		■		Standard
	HS1TB	12	35/35 W	PX43t	T4.625			2	B		■		Standard
	HS1SB	12	35/35 W	PX43t	T4.625			1	B		■		Standard
LOW BEAM, HIGH BEAM, FOG LIGHT (WHERE APPLICABLE)													

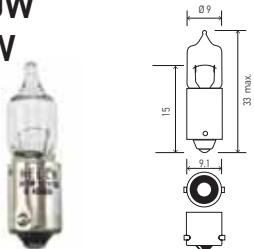
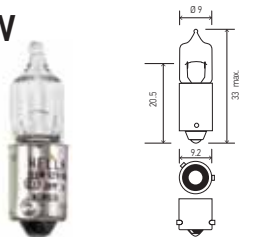

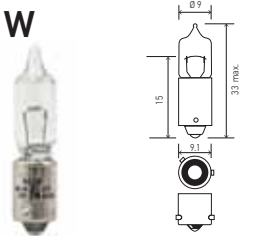
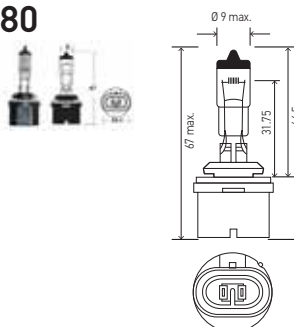
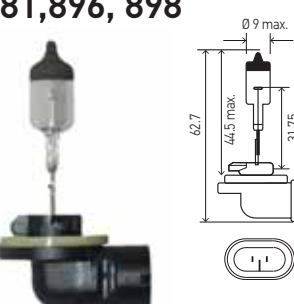
Product Image / Dimensions	Part Number	Voltage	Wattage	Base	Shape	Luminous Flux (lumens)	Kelvin	Content	Packaging	DOT	ECE	INMETRO	Features	
H20W H5W 	H20W	12	20 W	BA9s	T2.75	470		1	C				Standard	
	H5W	12	5 W	BA9s	T2.75	80		1	C				Standard	
FLASHER LIGHT, REAR TURN SIGNAL, FRONT, SIDE AND TAIL LIGHT														
H6W 	H6W	12	6 W	BAX9s	T2.75	125		1	C		■		Standard	
	PARKING LIGHT													
H10W 	◆ H10W	12	10 W	BA9s	T2.75			1	C			■	Standard	
	PARKING LIGHT													
H21W 	H21W	12	21 W	BAY9s	T2.75	600		1	C		■	■	Standard	
	H21W 24V	24	21 W	BAY9s	T2.75			1	C		■	■	Standard	
FLASHER LIGHT, REAR TURN SIGNAL, FRONT, SIDE AND TAIL LIGHT														
880 	880	12	27 W	PG13	T3.25	540		1	C		■	■	Standard	
	H71071172*	12	27 W	PG13	T3.25			2	P				Extreme Yellow XY	
	H71071212*	12	32 W	PG13	T3.25			2	P				Extreme White XB	
	880 YL	12	27 W	PG13	T3.25			2	B				Xtreme Yellow	
Many bulbs of the 800 series are physically interchangeable but not electrically. Serious damage and blinding by glare can result from misuse of the bulb, so it is important to use only the bulb that is specified for each application.														
LOW BEAM, HIGH BEAM, FOG LIGHT (WHERE APPLICABLE)														
881, 896, 898 	881	12	27 W	PGJ13	T3.25	540		1	C		■	■	Standard	
	896	12	37.5 W	PGJ13	T3.25	940	3100	1	C				Standard	
	898	12	37.5 W	PGJ13	T3.25	750	3100	1	C				Standard	
	H71071182*	12	27 W	PGJ13	T3.25				2	P				Extreme Yellow XY
	H71071222*	12	32 W	PGJ13	T3.25				2	P				Extreme White XB
	Many bulbs of the 800 series are physically interchangeable but not electrically. Serious damage and blinding by glare can result from misuse of the bulb, so it is important to use only the bulb that is specified for each application.													
LOW BEAM, FOG LIGHT (WHERE APPLICABLE)														

C = Box B = Blister Pack P = Plastic Case
 * = OPTILUX Product Range ◆ = New Product

Measures in millimeters

Product Image / Dimensions	Part Number	Voltage	Wattage	Base	Shape	Luminous Flux (lumens)	Kelvin	Content	Packaging	DOT	ECE	INMETRO	Features
----------------------------	-------------	---------	---------	------	-------	------------------------	--------	---------	-----------	-----	-----	---------	----------

884, 885, 887, 890, 892

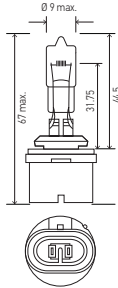

884	12	27 W	PG13	T3.25	540			1	C				Standard
885	12	50 W	PG13	T3.25	1250			1	C				Standard
887	12	50 W	PG13	T3.25	1190			1	C				Standard
890	12	27 W	PG13	T3.25	540	1100		1	C				Standard
892	12	16 W	PG13	T3.25	350			1	C				Standard

Many bulbs of the 800 series are physically interchangeable but not electrically. Serious damage and blinding by glare can result from misuse of the bulb, so it is important to use only the bulb that is specified for each application.

LOW BEAM, FOG LIGHT (WHERE APPLICABLE)

891

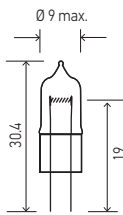

891	12	8 W	G4	T3.25	135	3100		1	C				Standard
------------	----	-----	----	-------	-----	------	--	---	---	--	--	--	----------

LOW BEAM, FOG LIGHT (WHERE APPLICABLE)

893

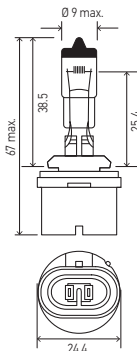

893	12	37.5 W	PG13	T3.25	940			1	C				Standard
H71071192*	12	37.5 W	PG13	T3.25				2	P				Extreme Yellow XY
H71071232*	12	37.5 W	PG13	T3.25				2	P				Extreme White XB

Many bulbs of the 800 series are physically interchangeable but not electrically. Serious damage and blinding by glare can result from misuse of the bulb, so it is important to use only the bulb that is specified for each application.

LOW BEAM, FOG LIGHT (WHERE APPLICABLE)

862, 886, 888, 889, 894

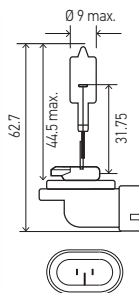

862	12	37.5 W	PGJ13	T3.25	750			1	C				Standard
886	12	50 W	PGJ13	T3.25	1190			1	C				Standard
888	12	50 W	PGJ13	T3.25	540			1	C				Standard
889	12	27 W	PGJ13	T3.25	540			1	C				Standard
889 YL	12	35 W	PGJ13	T3.25				2	B				Xtreme Yellow
894	12	37.5 W	PGJ13	T3.25	940			1	C				Standard

Many bulbs of the 800 series are physically interchangeable but not electrically. Serious damage and blinding by glare can result from misuse of the bulb, so it is important to use only the bulb that is specified for each application.

LOW BEAM, HIGH BEAM, FOG LIGHT (WHERE APPLICABLE)

9003

HB2

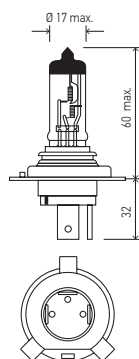



9003	12	60/55 W	P43t	T4.625	1500/910			1	C	■			Standard
9003LL	12	60/55 W	P43t	T4.625	1500/910			1	C	■			Long Life
◆ 9003 2.0TB	12	60/55 W	P43t	T4.625	1500/910	3600		2	P	■	■	■	High Performance 2.0
◆ 9003TB	12	60/55 W	P43t	T4.625	1500/910			2	B	■			Standard
◆ 9003SB	12	60/55 W	P43t	T4.625	1500/910			1	B	■			Standard

LOW BEAM, HIGH BEAM, FOG LIGHT (WHERE APPLICABLE)

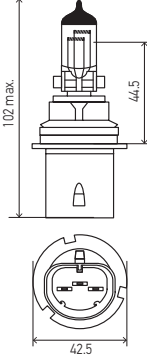

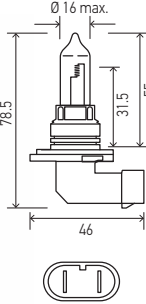
Product Image / Dimensions	Part Number	Voltage	Wattage	Base	Shape	Luminous Flux (lumens)	Kelvin	Content	Packaging	DOT	ECE	INMETRO	Features
9004 HB1  	9004	12	65/45 W	P29t	T4.625	1200/700		1	C	■			Standard
	9004P50	12	65/45 W	P29t	T4.625	1250/765		1	C	■			+ 50
	◆ 9004P50TB	12	65/45 W	P29t	T4.625	1250/765		2	B	■			+50
	9004XE-CB	12	65/45 W	P29t	T4.625	1100/700	3600	1	C				Clear Blue
	9004XE-100CB	12	100/80 W	P29t	T4.625	1250/1100	3600	1	C				Clear Blue/High W
	9004 100/80W	12	100/80 W	P29t	T4.625	1600/1300		1	C				High Wattage
	◆ 9004 100/80WSB	12	100/80 W	P29t	T4.625	1600/1300		2	B				High Wattage
	◆ 9004 2.0TB	12	65/45 W	P29t	T4.625	1200/700	3700	2	P	■		■	High Performance 2.0
	9004LL	12	65/45 W	P29t	T4.625	1200/700		1	C				Long Life
	9004 YL	12	65/45 W	P29t	T4.625	1200/700	2800	2	B				Xtreme Yellow
	H71071392*	12	65/45 W	P29t	T4.625			2	P	■			Extreme White XB
	H71070327*	12	100/80 W	P29t	T4.625			2	P				Extreme White XB
	H71070562*	12	65/45 W	P29t	T4.625			2	P				Extreme Yellow XY
	◆ 9004TB	12	65/45 W	P29t	T4.625	1200/700		2	B	■		■	Standard
	◆ 9004SB	12	65/45 W	P29t	T4.625	1200/700		2	B	■		■	Standard
	LOW BEAM, HIGH BEAM, FOG LIGHT (WHERE APPLICABLE)												



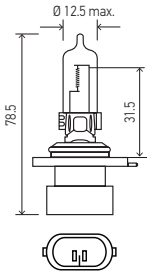

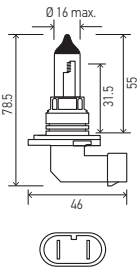

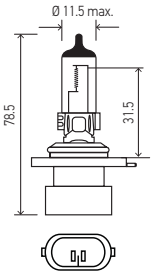

9005 HB3  	9005	12	65 W	P20d	T4	1860		1	C	■	■	■	Standard	
	9005P50	12	65 W	P20d	T4	2000		1	C	■	■	■	+ 50	
	◆ 9005P50TB	12	65 W	P20d	T4	2000		2	B	■	■	■	+ 50	
	9005XE-100CB	12	100 W	P20d	T4	1530	3600	1	C				Clear Blue/High W	
	9005 100W	12	100 W	P20d	T4	2200		1	C				High Wattage	
	◆ 9005 100WSB	12	100 W	P20d	T4	2200		2	B				High Wattage	
	◆ 9005 2.0TB	12	65 W	P20d	T4	1860	3700	2	P	■	■	■	High Performance 2.0	
	9005LL	12	65 W	P20d	T4	1860		1	C	■	■	■	Long Life	
	9005 YL	12	65 W	P20d	T4	1860	2900	2	B				Xtreme Yellow	
	H71071402*	12	65 W	P20d	T4			2	P				Extreme White XB	
	H71070347*	12	100 W	P20d	T4			2	P				Extreme White XB	
	H71070582*	12	65 W	P20d	T4			2	P				Extreme Yellow XY	
	◆ 9005TB	12	65 W	P20d	T4	1860		2	B	■	■	■	Standard	
	◆ 9005SB	12	65 W	P20d	T4	1860		1	B	■	■	■	Standard	
	LOW BEAM, HIGH BEAM, FOG LIGHT (WHERE APPLICABLE)													

9005XS HB3A  	9005XS	12	65 W	P20d	T4	1860		1	C	■	■	■	Standard
	H71071412*	12	65 W	P20d	T4			2	P				Extreme White XB
	H71071422*	12	100 W	P20d	T4			2	P				Extreme White XB
LOW BEAM, HIGH BEAM, FOG LIGHT (WHERE APPLICABLE)													

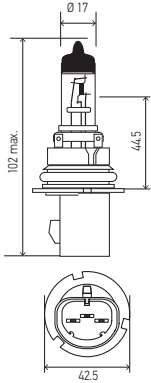

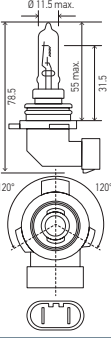

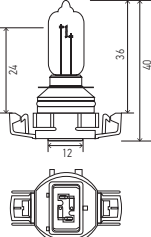

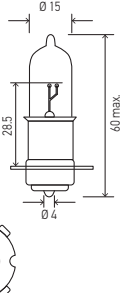

9006 HB4  	9006	12	55 W	P22d	T4	1095		1	C	■	■	■	Standard	
	9006P50	12	55 W	P22d	T4	1200		1	C	■	■	■	+ 50	
	◆ 9006P50TB	12	55 W	P22d	T4	1200		2	B	■	■	■	+ 50	
	9006XE-80CB	12	80 W	P22d	T4	1300	3600	1	C				Clear Blue/High W	
	9006 80W	12	80 W	P22d	T4	1650		1	C				High Wattage	
	◆ 9006 80WSB	12	80 W	P22d	T4	1650		2	B				High Wattage	
	◆ 9006 2.0TB	12	55 W	P22d	T4	1095	3700	2	P	■	■	■	High Performance 2.0	
	9006LL	12	55 W	P22d	T4	1095		1	C	■	■	■	Long Life	
	9006 YL	12	55 W	P22d	T4	1095	2900	2	B				Xtreme Yellow	
	H71071432*	12	55 W	P22d	T4			2	P				Extreme White XB	
	H71070367*	12	80 W	P22d	T4			2	P				Extreme White XB	
	H71070602*	12	55 W	P22d	T4			2	P				Extreme Yellow XY	
	◆ 9006TB	12	55 W	P22d	T4	1095		2	B	■	■	■	Standard	
	◆ 9006SB	12	55 W	P22d	T4	1095		1	B	■	■	■	Standard	
	LOW BEAM, HIGH BEAM, FOG LIGHT (WHERE APPLICABLE)													

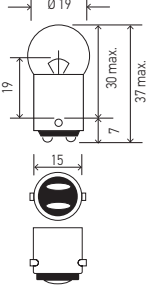

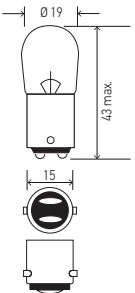

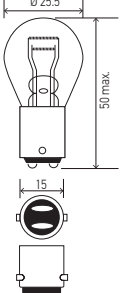

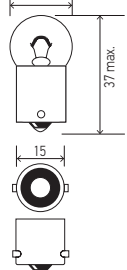
C = Box B = Blister Pack P = Plastic Case
 * = OPTILUX Product Range ◆ = New Product

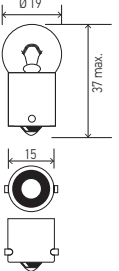
Measures in millimeters

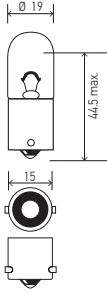

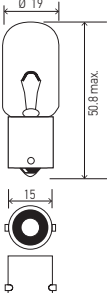

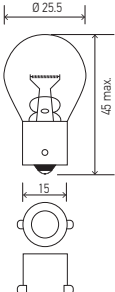

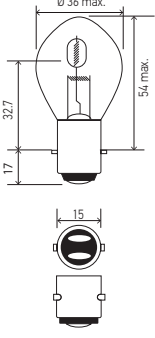

Product Image / Dimensions	Part Number	Voltage	Wattage	Base	Shape	Luminous Flux (lumens)	Kelvin	Content	Packaging	DOT	ECE	INMETRO	Features
9006XS HB4A  	9006XS	12	55 W	P22d	T4	1095		1	C	■	■	■	Standard
	H71071442*	12	55 W	P22d	T4			2	P				Extreme White XB
	H71071452*	12	80 W	P22d	T4			2	P				Extreme White XB
	H71071462*	12	55 W	P22d	T4			2	P				Extreme Yellow XY
	LOW BEAM, HIGH BEAM, FOG LIGHT (WHERE APPLICABLE)												
9007 HB5  	9007	12	65/55 W	PX29t	T4.625	1350/1000		1	C	■			Standard
	9007P50	12	65/55 W	PX29t	T4.625	1450/1100		1	C	■			+ 50
	◆ 9007P50TB	12	65/55 W	PX29t	T4.625	1450/1100		2	B	■			+ 50
	9007XE-CB	12	65/55 W	PX29t	T4.625	1350/1000	3700	1	C				Clear Blue
	9007 100/80W	12	100/80 W	PX29t	T4.625	1800/1500		1	C				High Wattage
	◆ 9007 100/80WSB	12	100/80 W	PX29t	T4.625	1800/1500		2	B	■			High Wattage
	◆ 9007 2.0TB	12	65/55 W	PX29t	T4.625	1350/1000	3700	2	P	■			High Performance 2.0
	9007LL	12	65/55 W	PX29t	T4.625	1350/1000		1	C				Long Life
	9007 YL	12	65/55 W	PX29t	T4.625	1350/1000	2800	2	B				Xtreme Yellow
	H71071472*	12	65/55 W	PX29t	T4.625			2	P				Extreme White XB
	H71070387*	12	100/80 W	PX29t	T4.625			2	P				Extreme White XB
	H71070622*	12	60/55 W	PX29t	T4.625			2	P				Extreme Yellow XY
	◆ 9007TB	12	60/55 W	PX29t	T4.625	1350/1000		2	B				Standard
◆ 9007SB	12	60/55 W	PX29t	T4.625	1350/1000		1	B				Standard	
LOW BEAM, HIGH BEAM, FOG LIGHT (WHERE APPLICABLE)													
9012 HIR2  	◆ 9012LL	12	55 W	PX22d	T4			1	C	■	■		Long Life
	LOW BEAM, HIGH BEAM												
9009S  	H71071282*	12	35 W	PG20-3	T4			2	P				Extreme White XB
	H71071302*	12	35 W	PG20-3	T4			2	P				Extreme Yellow XY
	LOW BEAM, HIGH BEAM, FOG LIGHT (WHERE APPLICABLE)												
M5  	◆ M5 35/35W	12	35/35 W	P15d-25-1		840/805		1	C				Standard
	◆ M5 35/35WTB	12	35/35 W	P15d-25-1		840/805		2	B				Standard
	◆ M5 35/35WSB	12	35/35 W	P15d-25-1		840/805		1	B				Standard
	◆ M5 35/35W1	12	35/35 W	BA20D		840/805		1	C	■			Standard
	◆ M5 25/25W	12	25/25 W	BA20D		540/540		1	C	■			Standard
	◆ M5 25/25W1	12	25/25 W	P15D-25-1		540/540		1	C	■			Standard
	◆ M5 18/18W	12	18/18 W	P15D-25-1		440/440		1	C	■			Standard
	◆ M5 35/35W3	12	35/35 W	P15D-25-3		840/805		1	C	■			Standard
	◆ M5 25/25W3	12	25/25 W	P15D-25-3		540/540		1	C	■			Standard
	LOW BEAM, HIGH BEAM, FOG LIGHT (WHERE APPLICABLE)												

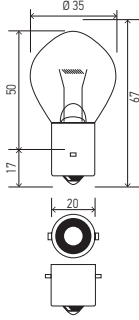

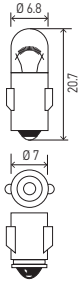
Product Image / Dimensions	Part Number	Voltage	Wattage	Base	Shape	Luminous Flux (lumens)	Kelvin	Content	Packaging	DOT	ECE	INMETRO	Features
BA15d  	90	12	8 W	BA15d	G6	125		10	C	■			Standard
	1224	32	5 W	BA15d	G6	125		10	C	■			Standard
STOP LIGHT, REAR POSITION LIGHT													
BA15d  	1004	12	12.8 W	BA15d	B6			10	C	■			Standard
	PARKING LIGHT, LICENSE PLATE LIGHT, GLOVE COMPARTMENT LIGHT, TRUNK LIGHT												
BA15d  	1176	12	17/8 W	BA15d	S8			10	C	■			Standard
	◆ 1176A	12	16/8 W	BA15d	S8			10	C	■			Standard (Amber)
	◆ 7240	12	21/5 W	BA15d	S8			10	C				Standard
	◆ 7533	12	15 W	BA15d	S8			10	C				Standard
	◆ 7534	24	21/5 W	BA15d	S8			10	C				Standard
	◆ 7534TB	24	21/5 W	BA15d	S8			2	B				Standard
STOP LIGHT, REAR POSITION LIGHT													
BA15s  	63	6	4 W	BA15s	G6			10	C	■			Standard
	631	12	9 W	BA15s	G6			10	C	■			Standard
	67	12	8 W	BA15s	G6			10	C	■			Standard
	89	12	8 W	BA15s	G6			10	C	■			Standard
	◆ 97	12	9 W	BA15s	G6			10	C	■			Standard
PARKING LIGHT, LICENSE PLATE LIGHT													
BA15s  	5007	12	5 W	BA15s	B6			10	C	■	■		Standard
	◆ 5007TB	12	5 W	BA15s	B6			2	B		■	■	Standard
	◆ 5007SB	12	5 W	BA15s	B6			1	B		■	■	Standard
	5008	12	10 W	BA15s	B6			10	C		■	■	Standard
	◆ 5008TB	12	10 W	BA15s	B6			2	B		■	■	Standard
	◆ 5008SB	12	10 W	BA15s	B6			1	B		■	■	Standard
	5627	24	5 W	BA15s	B6			10	C		■	■	Standard
	◆ 5627SB	24	5 W	BA15s	B6			1	B		■	■	Standard
	◆ 5627TB	24	5 W	BA15s	B6			2	B		■	■	Standard
	◆ 5637	24	10 W	BA15s	B6			10	C		■	■	Standard
	5637TB	24	10 W	BA15s	B6			2	B		■	■	Standard
	5637HD	24	10 W	BA15s	B6			10	C		■	■	Heavy Duty
	PARKING LIGHT, LICENSE PLATE LIGHT												

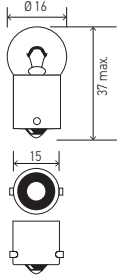
Product Image / Dimensions	Part Number	Voltage	Wattage	Base	Shape	Luminous Flux (lumens)	Kelvin	Content	Packaging	DOT	ECE	INMETRO	Features
BA15s  	1003	12	12 W	BA15s	B6			10	C	■			Standard
	1003LL	12	12 W	BA15s	B6			10	C	■			Long Life
	1308	24	16 W	BA15s	B6					■			Standard
	PARKING LIGHT, LICENSE PLATE LIGHT, GLOVE COMPARTMENT LIGHT, TRUNK LIGHT												
BA15s  	3497	12	25 W	BA15s	T6			10	C	■			Standard
	PARKING LIGHT, LICENSE PLATE LIGHT, GLOVE COMPARTMENT LIGHT, TRUNK LIGHT												
BA15s P21W PY21W  	93	12	13 W	BA15s	S8			10	C	■			Standard
	199	12	29 W	BA15s	S8			10	C	■			Standard (35 MSCP)
	1073	12	23 W	BA15s	S8			10	C	■			Standard
	1141	12	18 W	BA15s	S8			10	C	■			Standard
	◆ 1141TB	12	18 W	BA15s	S8			2	B	■			Standard
	◆ 1141 24V	24	18 W	BA15s	S8			10	C	■			Standard
	◆ 1141 24VSB	24	18 W	BA15s	S8			1	B				Standard
	◆ 1141 24VTB	24	18 W	BA15s	S8			2	B				Standard
	1141LL	12	18 W	BA15s	S8			10	C	■			Long Life
	1156	12	27 W	BA15s	S8			10	C	■			Standard
	1156LL	12	27 W	BA15s	S8			10	C	■			Long Life
	1156NA	12	27 W	BA15s	S8			10	C	■			Standard (Nat. amber)
	1683	24	29 W	BA15s	S8			10	C	■			Standard
	2396	12	29 W	BA15s	S8			10	C	■			Standard (40 MSCP)
	7506A	12	21 W	BA15s	S8			10	C			■	Standard (Amber)
	◆ 7506	12	21 W	BA15s	S8			10	C		■		Standard
	◆ 7506TB	12	21 W	BA15s	S8			2	B		■	■	Standard
	7506ATB	12	21 W	BA15s	S8			2	B		■	■	Standard
	◆ 7511	24	21 W	BA15s	S8			10	C		■	■	Standard
	◆ 7511TB	24	21 W	BA15s	S8			2	B		■	■	Standard
7511SB	24	21 W	BA15s	S8			1	B		■	■	Standard	
7506NA	12	21 W	BA15s	S8			10	C				Standard (Nat. amber)	
FLASHING LIGHT, STOP LIGHT, REAR FOG LIGHT, REVERSE LIGHT, SIGNAL LIGHT													
BA20d S2  	6235	12	35/35 W	BA20d	B11			1	C		■		Standard
	◆ 6235SB	12	35/35 W	BA20d	B11			1	B				Standard
	6245	12	45/40 W	BA20d	B11			1	C				Standard
	6260	12	60/60 W	BA20d	B11			1	C				Standard (High W.)
LOW BEAM, HIGH BEAM													

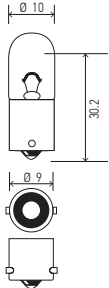

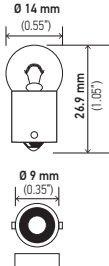

Product Image / Dimensions	Part Number	Voltage	Wattage	Base	Shape	Luminous Flux (lumens)	Kelvin	Content	Packaging	DOT	ECE	INMETRO	Features
BA20s  	660	12	60 W	BA20s	B11			1	C				Standard (High W.)
	635	12	35 W	BA20s	B11			1	C				Standard
LOW BEAM, HIGH BEAM													
BA7s  	3799	6	1 W	BA7s	T2			10	C				Standard
	3898	12	2 W	BA7s	T2			10	C				Standard
	3898TB	12	2 W	BA7s	T2			2	B				Standard
	3899	24	3 W	BA7s	T2			10	C				Standard
DASHBOARD LIGHT													
BA9s  	51	6	12 W	BA9s	G3.5			10	C	■			Standard
	53	12	2 W	BA9s	G3.5			10	C	■			Standard
	53TB	12	2 W	BA9s	G3.5			2	B				Standard
	57	12	3 W	BA9s	G4.5			10	C	■		■	Standard
	265	24	2 W	BA9s	G3.5			10	C	■			Standard
	1445	12	2 W	BA9s	G3.5			10	C	■			Standard
PARKING LIGHT, DASHBOARD LIGHT													
BA9s  	1816	12	4 W	BA9s	T3.25			10	C	■			Standard
	1891	12	3 W	BA9s	T3.25			10	C	■			Standard
	1893	12	5 W	BA9s	T3.25			10	C	■			Standard
PARKING LIGHT													
BA9s  	1895	12	4 W	BA9s	G4.5			10	C	■			Standard
PARKING LIGHT, DASHBOARD LIGHT													

C = Box B = Blister Pack P = Plastic Case
 * = OPTILUX Product Range ◆ = New Product

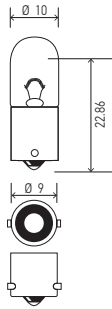
Measures in millimeters

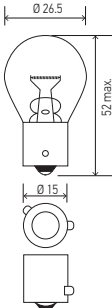
Product Image / Dimensions	Part Number	Voltage	Wattage	Base	Shape	Luminous Flux (lumens)	Kelvin	Content	Packaging	DOT	ECE	INMETRO	Features	
BA9s  	3796	12	2 W	BA9s	T2.75			10	C				Standard	
	3797	24	2 W	BA9s	T2.75			10	C				Standard	
	♦ 3797TB	24	2 W	BA9s	T2.75			2	B				Standard	
	3893	12	4 W	BA9s	T2.75			10	C	■	■		Standard	
	3893TB	12	4 W	BA9s	T2.75			2	B	■	■		Standard	
	♦ 3893SB	12	4 W	BA9s	T2.75			1	B	■	■		Standard	
	3930	24	4 W	BA9s	T2.75			10	C	■	■		Standard	
	♦ 3930TB	24	4 W	BA9s	T2.75			2	B	■	■		Standard	
	PARKING LIGHT													

BAU15s P21W PY21W  	7507C	12	21 W	BAU15s	S8			10	C				Standard
	♦ 7507CTB	12	21 W	BAU15s	S8			2	B				Standard
	7507	12	21 W	BAU15s	S8			10	C		■	■	Standard
	♦ 7507TB	12	21 W	BAU15s	S8			2	B		■	■	Standard
	7510LTS	24	21 W	BAU15s	S8			10	C				Heavy Duty
	♦ 7510LTSTB	24	21 W	BAU15s	S8			2	B				Standard
	9507	24	21 W	BAU15s	S8			10	C		■	■	Standard (Amber)
	♦ 9507TB	24	21 W	BAU15s	S8			2	B		■	■	Standard (Amber)
	♦ 5009	12	10 W	BAU15s	S8			10	C				Standard
	FLASHING LIGHT AND FRONT, REAR SIDE SIGNAL LIGHT												

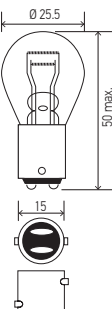
BAY15d  	198HD	12	29/10 W	BAY15d	S8			10	C	■			Heavy Duty	
	1034	12	23/8 W	BAY15d	S8			10	C	■			Standard	
	1034A	12	23/8 W	BAY15d	S8			10	C	■			Standard (Amber)	
	1034NA	12	23/8 W	BAY15d	S8			10	C	■			Standard (Nat. amber)	
	♦ 1034TB	12	23/8 W	BAY15d	S8			2	B	■			Standard	
	1157	12	27/8 W	BAY15d	S8			10	C	■			Standard	
	♦ 1157TB	12	27/8 W	BAY15d	S8			2	B	■			Standard	
	1157LL	12	27/8 W	BAY15d	S8			10	C	■			Long Life	
	♦ 1157A	12	27/8 W	BAY15d	S8			10	C	■			Standard	
	1157NA	12	27/8 W	BAY15d	S8			10	C	■			Standard (Nat. amber)	
	2057	12	27/7 W	BAY15d	S8			10	C	■			Standard	
	2057LL	12	27/7 W	BAY15d	S8			10	C	■			Long Life	
	2057NA	12	27/7 W	BAY15d	S8			10	C	■			Standard (Nat. amber)	
	2057NALL	12	27/7 W	BAY15d	S8			10	C	■			Long Life (Nat. amber)	
	2357	12	29/8 W	BAY15d	S8			10	C	■			Standard	
	2357LL	12	29/8 W	BAY15d	S8			10	C	■			Long Life	
	2357NA	12	29/8 W	BAY15d	S8			10	C	■			Standard (Nat. amber)	
	2397	12	29/8 W	BAY15d	S8			10	C	■			Standard	
	STOP LIGHT, REAR POSITION LIGHT													

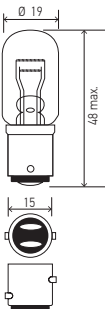
BAY15d  	3496	12	27/8 W	BAY15d	T6			10	C	■			Standard
	LOW BEAM, HIGH BEAM, FOG LIGHT (WHERE APPLICABLE)												

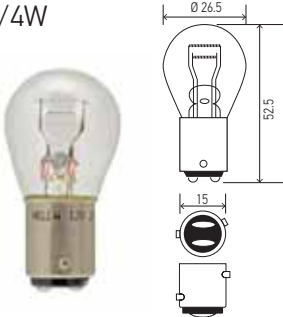

Product Image / Dimensions	Part Number	Voltage	Wattage	Base	Shape	Luminous Flux (lumens)	Kelvin	Content	Packaging	DOT	ECE	INMETRO	Features
BAY15d 	7528	12	21/5 W	BAY15d	S8			10	C		■	■	Standard
	7537	24	21/5 W	BAY15d	S8			10	C				Standard
	◆ 7537SB	24	21/5 W	BAY15d	S8			1	B		■	■	Standard
	◆ 7537TB	24	21/5 W	BAY15d	S8			2	B		■	■	Standard
	7528TB	12	21/5 W	BAY15d	S8			2	B				Standard
	7528SB	12	21/5 W	BAY15d	S8			1	B				Standard
	STOP LIGHT, REAR POSITION LIGHT												

BAZ15d P21/4W 	7225	12	21/4 W	BAZ15d	S8			10	C		■	■	Standard
	◆ 7225TB	12	21/4 W	BAZ15d	S8			2	B		■	■	Standard
POSITION LIGHT, REAR FOG LIGHT, STOP LIGHT													

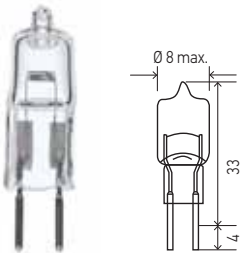

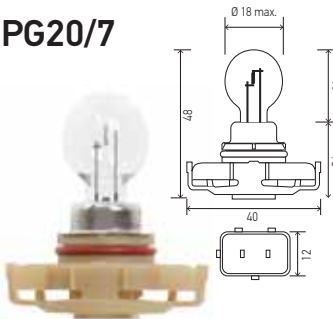

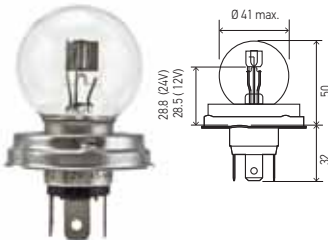

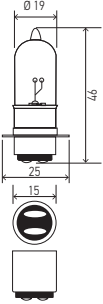

G4 	JC20	12	20 W	G4	T3			10	C				Standard
	JC5	12	5 W	G4	T3			10	C				Standard
	JC10	12	10 W	G4	T3			10	C				Standard
LOW BEAM, HIGH BEAM, FOG LIGHT (WHERE APPLICABLE)													

PG20/7 	◆ PSX24W	12	24 W	PG20/7	S8			1	C		■		Standard
LOW BEAM, HIGH BEAM, FOG LIGHT (WHERE APPLICABLE)													

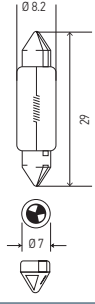
P45t R2 	7951	12	45/40 W	P45t	S13			10	C		■	■	Standard
	7951 55/50W	12	55/50 W	P45t	S13			10	C				Standard
	7952	24	55/50 W	P45t	S13			10	C		■		Standard
	◆ 7952TB	24	55/50 W	P45t	S13			2	B			■	Standard
	LOW BEAM, HIGH BEAM, FOG LIGHT (WHERE APPLICABLE)												

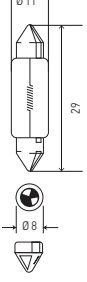
C = Box B = Blister Pack P = Plastic Case
 * = OPTILUX Product Range ◆ = New Product

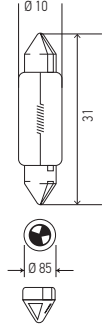
Measures in millimeters

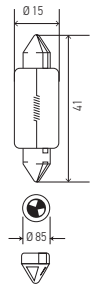
Product Image / Dimensions	Part Number	Voltage	Wattage	Base	Shape	Luminous Flux (lumens)	Kelvin	Content	Packaging	DOT	ECE	INMETRO	Features
PX15d  	A3603	12	25/25 W	PX15d	T6			1	C				Standard
	A3625	6	25/25 W	PX15d	T6			1	C				Standard
LOW BEAM, HIGH BEAM, FOG LIGHT (WHERE APPLICABLE)													
SV7-8  	DE3021	12	3 W	SV7-8	T2.25			10	C	■			Standard (8x29mm)
	◆ DE3021TB	12	3 W	SV7-8	T2.25			2	B	■			Standard (8x29mm)
	◆ DE3021SB	12	3 W	SV7-8	T2.25			1	B	■			Standard (8x29mm)
	DE3022	12	5 W	SV7-8	T2.25			10	C	■			Standard (8x29mm)
PARKING LIGHT, LICENSE PLATE LIGHT, GLOVE COMPARTMENT LIGHT, INTERIOR LIGHT, TRUNK LIGHT													
SV7-8  	6428	12	3 W	SV7-8	T2.5			10	C				Standard (8x28mm)
	6430	24	3 W	SV7-8	T2.5			10	C				Standard (8x29mm)
	6438	12	10 W	SV7-8	T2.5			10	C				Standard (8x31mm)
PARKING LIGHT, LICENSE PLATE LIGHT, GLOVE COMPARTMENT LIGHT, INTERIOR LIGHT, TRUNK LIGHT													
SV8.5-8  	DE3175	12	10 W	SV8.5-8	T3.25			10	C	■			Standard (10x31mm)
	◆ DE3175TB	12	10 W	SV8.5-8	T3.25			2	B	■			Standard (10x31mm)
	◆ DE3175SB	12	10 W	SV8.5-8	T3.25			1	B				Standard (10x31mm)
	DE3425	12	10 W	SV8.5-8	T3.25			10	C	■			Standard (13x37mm)
	6411	12	10 W	SV8.5-8	T3.25			10	C				Standard (10x41mm)
	◆ 6411TB	12	10 W	SV8.5-8	T3.25			2	B				Standard (10x41mm)
	◆ 6411LED 6.5K	12	1 W	SV8.5-8	T3.25			1	B				LED
	◆ 6411LED 5K	12	1 W	SV8.5-8	T3.25			1	B				LED
	6418	12	5 W	SV8.5-8	T3.25			10	C		■	■	Standard (10x35mm)
	◆ 6418TB	12	5 W	SV8.5-8	T3.25			2	B		■	■	Standard (10x35mm)
	◆ 6418LED 6.5K	12	1 W	SV8.5-8	T3.25			1	B				LED
	◆ 6418LED 5K	12	1 W	SV8.5-8	T3.25			1	B				LED
	6423	24	5 W	SV8.5-8	T3.25			10	C		■	■	Standard (10x35mm)
	◆ 6423TB	24	5 W	SV8.5-8	T3.25			2	B		■	■	Standard (10x35mm)
	6429	24	10 W	SV8.5-8	T3.25			10	C				Standard (11x41mm)
◆ 6429TB	24	10 W	SV8.5-8	T3.25			2	B				Standard (11x41mm)	
PARKING LIGHT, LICENSE PLATE LIGHT, GLOVE COMPARTMENT LIGHT, INTERIOR LIGHT, TRUNK LIGHT													
SV8.5-8  	6451	12	15 W	SV8.5-8	T4.625			10	C				Standard (15x44mm)
	6453	24	15 W	SV8.5-8	T4.625			10	C				Standard (15x44mm)
	6475	12	18 W	SV8.5-8	T4.625			10	C				Standard (15x41mm)
	6476	12	21 W	SV8.5-8	T4.75			10	C			■	Standard (15x43mm)
	6480	24	18 W	SV8.5-8	T4.625			10	C				Standard (15x43mm)
PARKING LIGHT, LICENSE PLATE LIGHT, GLOVE COMPARTMENT LIGHT, INTERIOR LIGHT, TRUNK LIGHT													

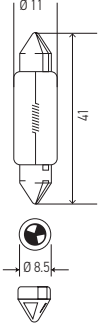

Product Image / Dimensions	Part Number	Voltage	Wattage	Base	Shape	Luminous Flux (lumens)	Kelvin	Content	Packaging	DOT	ECE	INMETRO	Features
SV8.5-8 C5W  	6413	12	5 W	SV8.5-8	T3.25			10	C				Standard (11x41mm)
	6424	24	5 W	SV8.5-8	T3.25			10	C				Standard (11x41mm)
PARKING LIGHT, LICENSE PLATE LIGHT, GLOVE COMPARTMENT LIGHT, INTERIOR LIGHT, TRUNK LIGHT													

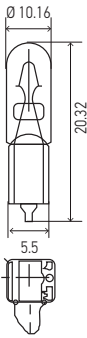



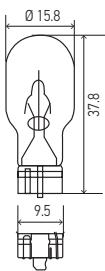

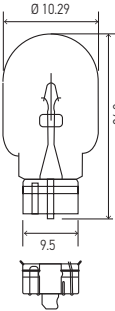

W2.1x4.9d  	17	24	2 W	W2.1x4.9d	T1.75			10	C	■			Standard
	73	12	1.1 W	W2.1x4.9d	T1.75			10	C	■			Standard
	◆ 73TB	12	1.1 W	W2.1x4.9d	T1.75			2	B	■			Standard
	74	12	1.4 W	W2.1x4.9d	T1.75			10	C	■		■	Standard
DASHBOARD LIGHT													

W2.1x9.5d  	158	12	3 W	W2.1x9.5d	T3.25			10	C	■			Standard
	158A	12	3 W	W2.1x9.5d	T3.25			10	C	■			Standard (Amber)
	◆ 158TB	12	3 W	W2.1x9.5d	T3.25			2	B	■			Standard
	168	12	5 W	W2.1x9.5d	T3.25			10	C	■			Standard
	◆ 168TB	12	5 W	W2.1x9.5d	T3.25			2	B	■			Standard
	194	12	4 W	W2.1x9.5d	T3.25			10	C	■			Standard
	194B	12	4 W	W2.1x9.5d	T3.25			10	C	■			Standard (Blue)
	194NA	12	4 W	W2.1x9.5d	T3.25			10	C	■			Standard (Nat. amber)
	194R	12	4 W	W2.1x9.5d	T3.25			10	C	■			Standard (Red)
	400	24	3 W	W2.1x9.5d	T3.25			10	C	■			Standard
	◆ 2840	24	2 W	W2.1x9.5d	T3.25			10	C	■			Standard
	DASHBOARD LIGHT												

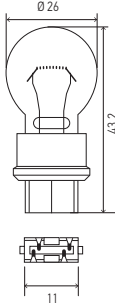

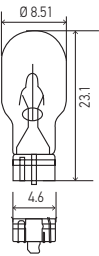

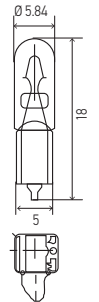

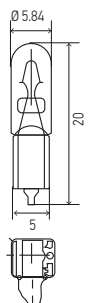

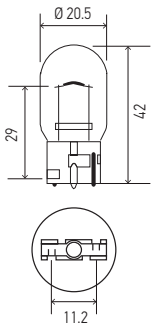

W2.1x9.5d  	912	12	13 W	W2.1x9.5d	T5			10	C	■			Standard
	921	12	16 W	W2.1x9.5d	T5			10	C	■	■		Standard
	◆ 921NA	12	18 W	W2.1x9.5d	T5			10	C	■	■		Standard
	◆ 921TB	12	16 W	W2.1x9.5d	T5			2	B	■	■		Standard
	◆ 921SB	12	16 W	W2.1x9.5d	T5			1	B	■	■		Standard
	◆ 921LED 6.5K	12	1 W	W2.1x9.5d	T5			2	B				LED
	◆ 921LED 5K	12	1 W	W2.1x9.5d	T5			2	B				LED
PARKING LIGHT													

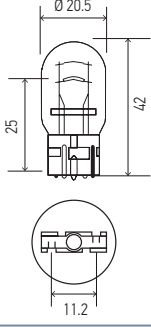
C = Box B = Blister Pack P = Plastic Case
 * = OPTILUX Product Range ◆ = New Product

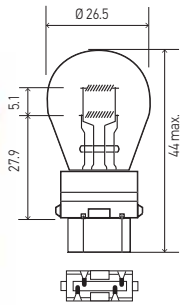
Measures in millimeters

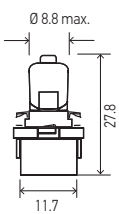

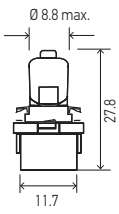

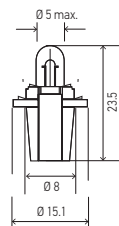





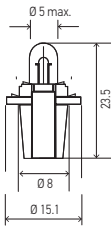

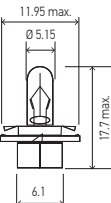
Product Image / Dimensions	Part Number	Voltage	Wattage	Base	Shape	Luminous Flux (lumens)	Kelvin	Content	Packaging	DOT	ECE	INMETRO	Features
W2.1x9.5d  	2820	12	2 W	W2.1x9.5d	T3.25			10	C				Standard
	2821	12	3 W	W2.1x9.5d	T3.25			10	C		■	■	Standard
	◆ 2821TB	12	3 W	W2.1x9.5d	T3.25			2	B		■	■	Standard
	◆ 2821SB	12	3 W	W2.1x9.5d	T3.25			1	B		■	■	Standard
	2825	12	5 W	W2.1x9.5d	T3.25			10	C		■	■	Standard
	2825BL	12	5 W	W2.1x9.5d	T3.25			10	C				Standard (Blue)
	◆ 2825TB	12	5 W	W2.1x9.5d	T3.25			2	B				Standard
	◆ 2825SB	12	5 W	W2.1x9.5d	T3.25			1	B		■		Standard
	2827NA	12	5 W	W2.1x9.5d	T3.25			10	C		■	■	Standard (Nat. amber)
	◆ 2827NATB	12	5 W	W2.1x9.5d	T3.25			2	B		■	■	Standard
	2841	24	3 W	W2.1x9.5d	T3.25			10	C		■	■	Standard
	◆ 2841TB	24	3W	W2.1x9.5d	T3.25			2	B		■	■	Standard
	2845	24	5 W	W2.1x9.5d	T3.25			10	C				Standard
	◆ 2845SB	24	5 W	W2.1x9.5d	T3.25			1	B		■	■	Standard
	◆ 2845TB	24	5 W	W2.1x9.5d	T3.25			2	B		■	■	Standard
	3652	12	5 W	W2.1x9.5d	T3.25			10	C				Standard
	PARKING LIGHT, DASHBOARD LIGHT, LICENSE PLATE LIGHT, GLOVE COMPARTMENT LIGHT, FLASHING LIGHT ADDITIONAL, INTERIOR LIGHT												
W2.5x16d  	3156	12	27 W	W2.5x16d	S8			10	C	■	■		Standard
	3047	12	21/7 W	W2.5X16q	S8			10	C	■			Standard
	3047LL	12	21/7 W	W2.5X16q	S8			10	C	■			Long Life
	3057	12	27/7 W	W2.5x16q	S8			10	C	■			Standard
	3157	12	27/7 W	W2.5x16q	S8			10	C	■			Standard
	3157LL	12	27/7 W	W2.5x16q	S8			10	C	■	■		Long Life
	◆ 3157TB	12	27/7 W	W2.5x16q	S8			2	B		■		Standard
	3157NA	12	27/7 W	W2.5x16q	S8			10	C	■			Standard (Nat. amber)
	3457	12	29/8 W	W2.5x16q	S8			10	C	■			Standard
	3457NA	12	29/8 W	W2.5x16q	S8			10	C	■			Standard (Nat. amber)
FLASHING LIGHT, REAR SIGNAL LIGHT													
W2x4.6d  	24	12	3 W	W2x4.6d	T2.75			10	C	■			Standard
	24NA	12	3 W	W2x4.6d	T2.75			10	C	■			Standard (Nat. amber)
LOW BEAM, HIGH BEAM, FOG LIGHT (WHERE APPLICABLE)													
W2x4.6d  	37	12	1.3 W	W2X4.6d	T1.75			10	C	■			Standard
LOW BEAM, HIGH BEAM, FOG LIGHT (WHERE APPLICABLE)													
W2x4.6d  	2721	12	1.2 W	W2x4.6d	T1.5			10	C	■		■	Standard
	◆ 2721TB	12	1.2 W	W2x4.6d	T1.5			2	B		■		Standard
	◆ 2722	12	21 W	W2x4.6d	T1.5			10	C			■	Standard
	2723	12	2.3 W	W2x4.6d	T1.5			10	C		■		Standard
	2741	24	1.2 W	W2x4.6d	T1.5			10	C				Standard
	◆ 2741TB	24	1.2 W	W2x4.6d	T1.5			2	B				Standard
DASHBOARD LIGHT													

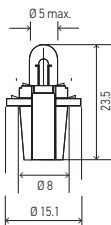

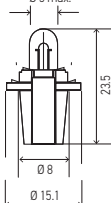

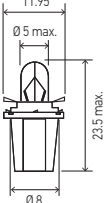

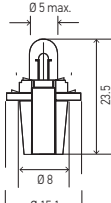

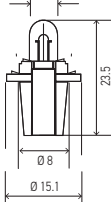
Product Image / Dimensions	Part Number	Voltage	Wattage	Base	Shape	Luminous Flux (lumens)	Kelvin	Content	Packaging	DOT	ECE	INMETRO	Features
W3x16d  	7440	12	21 W	W3x16d	T6.5			10	C	■	■	■	Standard
	7440LL	12	21 W	W3x16d	T6.5			10	C	■	■	■	Long Life
	7440NA	12	21 W	W3x16d	T6.5			10	C	■	■		Standard (Nat. amber)
	7440TB	12	21 W	W3x16d	T6.5			2	B	■			Standard
	7441	12	27 W	W3x16d	T6.5			10	C	■			Standard
	REAR POSITION LIGHT, STOP LIGHT												
W3x16d  	7443	12	21/5 W	W3x16d	T6.5			10	C	■	■	■	Standard
	7443LL	12	21/5 W	W3x16d	T6.5			10	C	■	■	■	Long Life
	7443A	12	21/5 W	W3x16d	T6.5			10	C	■			Standard (Amber)
	7443NA	12	21/5 W	W3x16d	T6.5			10	C	■			Standard (Nat. amber)
	7443TB	12	21/5 W	W3x16d	T6.5			2	B	■	■	■	Standard
	FLASHING LIGHT AND REAR SIGNAL LIGHT, ADDITIONAL FLASHING LIGHT, STOP LIGHT												
W2.5x16q  	3757A	12	27/7 W	W2.5x16q	S8			10	C	■			Standard (Amber)
	FLASHING LIGHT AND REAR SIGNAL LIGHT, STOP LIGHT												
B10d  	007997101	12	3 W	B10d				10	C				Brown base
	DASHBOARD LIGHT												
B10d  	007997111	12	5 W	B10d				10	C				Black base
	DASHBOARD LIGHT												
B8.3d  	007997061	24	1.2 W	B8.3d				10	C				Grey base
	DASHBOARD LIGHT												

C = Box B = Blister Pack P = Plastic Case
 * = OPTILUX Product Range ◆ = New Product

Measures in millimeters

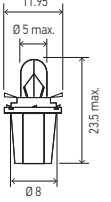

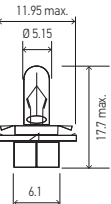

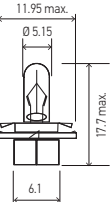



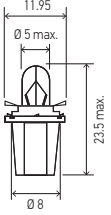

Product Image / Dimensions	Part Number	Voltage	Wattage	Base	Shape	Luminous Flux (lumens)	Kelvin	Content	Packaging	DOT	ECE	INMETRO	Features
 	007997001	12	2 W	B8.3d				10	C				White base
DASHBOARD LIGHT													
 	007997031	12	1.2 W	B8.5d				10	C				Black base
DASHBOARD LIGHT													
 	007997041	12	1.2 W	B8.3d				10	C				Black base
DASHBOARD LIGHT													
 	007997071	24	1.2 W	B8.5d				10	C				Grey base
DASHBOARD LIGHT													
 	007997081	12	2 W	B8.5d				10	C				Green base
DASHBOARD LIGHT													
 	007997051	12	2 W	B8.7d				10	C				Grey base
DASHBOARD LIGHT													
 	007997091	12	2 W	B8.7d				10	C				Green base
DASHBOARD LIGHT													

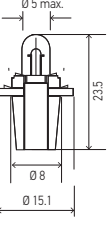

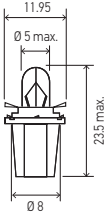

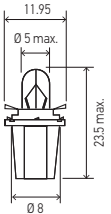

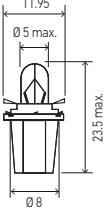
Product Image / Dimensions	Part Number	Voltage	Wattage	Base	Shape	Luminous Flux (lumens)	Kelvin	Content	Packaging	DOT	ECE	INMETRO	Features
	007997231	12	1.2 W	BG8.5-5.5d				10	C				Black base
	DASHBOARD LIGHT												
	007997241	12	1.2 W	BG8-5.5d				10	C				Black base
	DASHBOARD LIGHT												
	007997251	12	1.2 W	BG8.5-S/40				10	C				Black base
	DASHBOARD LIGHT												
 	007997121	12	1.2 W	BX8.4d				10	C				Black base
	DASHBOARD LIGHT												
 	007997131	12	1.5 W	BX8.4d				10	C				Green base
	DASHBOARD LIGHT												
 	007997141	12	1.5 W	BX8.4d				10	C				Beige base
	DASHBOARD LIGHT												
 	007997171	12	1.1 W	BX8.4d				10	C				Orange base
	DASHBOARD LIGHT												

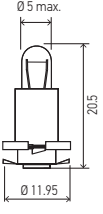
C = Box B = Blister Pack P = Plastic Case
 * = OPTILUX Product Range  = New Product

Measures in millimeters

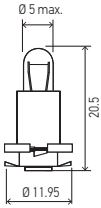
Product Image / Dimensions	Part Number	Voltage	Wattage	Base	Shape	Luminous Flux (lumens)	Kelvin	Content	Packaging	DOT	ECE	INMETRO	Features
 	007997151	12	0.36 W	BX8.5d				10	C				Violet base
DASHBOARD LIGHT													
 	007997161	12	1.5 W	BX8.5d				10	C				Beige base
DASHBOARD LIGHT													
 	007997211	12	1.2 W	BX8.5d				10	C				Blue base
DASHBOARD LIGHT													
 	007997221	12	2 W	BX8.5d				10	C				Light Green base
DASHBOARD LIGHT													
 	007997261	24	1.2 W	BX8.5d				10	C				Brown base
DASHBOARD LIGHT													
	007997272	24	1.2 W	EBS N10				10	C				Grey base
DASHBOARD LIGHT													
 	007997191	24	1.2 W	EBS R4				10	C				Yellow base
DASHBOARD LIGHT													

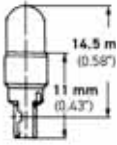

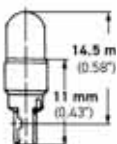
Product Image / Dimensions	Part Number	Voltage	Wattage	Base	Shape	Luminous Flux (lumens)	Kelvin	Content	Packaging	DOT	ECE	INMETRO	Features
EBS R6  	007997201	24	1.2 W	EBS R6				10	C				Brown base
	DASHBOARD LIGHT												
W2x4.6d  	007997011	12	1.2 W	W2x4.6d		T1.5		10	C				White base
	DASHBOARD LIGHT												
W2x4.6d  	007997021	24	1 W	W2x4.6d		T1.5		10	C				White base
	DASHBOARD LIGHT												

SEE THE WORLD WITH DIFFERENT LIGHTS













Mercury Free

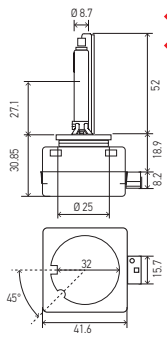

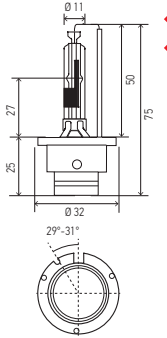
With a color temperature of 4300K, twice as bright as halogen bulbs and with about three times their luminous efficiency, the white light of these new generation xenon bulbs ensures safety and relaxed driving.

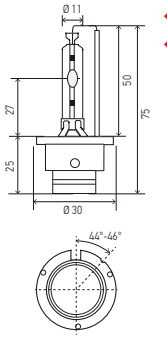
The new HELLA XENON +30 bulbs have a color temperature of up to 5000K, which rivals white LED daytime running lights, offer maximum illumination and visibility similar to daylight. With a low power consumption of 35W, resistance to vibrations and a long service life.

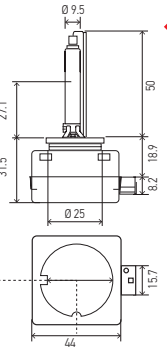
3.5 High Intensity Discharge Lamps (HID)

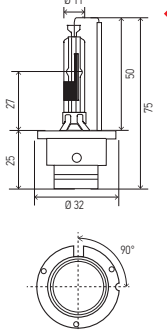
Product Image / Dimensions	Part Number	Voltage	Wattage	Base	Shape	Luminous Flux (lumens)	Kelvin	Content	Packaging	DOT	ECE	INMETRO	Features
 	◆ D1S 4300 K	12/24	35 W	PK32d-2	T3	3,200	4300	1	C		■		Standard
	◆ D1S 5000 K	12/24	35 W	PK32d-2	T3		5000	1	C		■		Performance +30
LOW BEAM, HIGH BEAM													
 	◆ D2R 4300 K	12/24	35 W	P32d-3	T3	3,200	4300	1	C		■		Standard
	◆ D2R 5000 K	12/24	35 W	P32d-3	T3	2,800	5000	1	C		■	■	Performance +30
LOW BEAM, HIGH BEAM													
 	◆ D2S 4300 K	12/24	35 W	P32d-2	T2-3/4	3,200	4300	1	C				Standard
	◆ D2S 5000 K	12/24	35 W	P32d-2	T2-3/4		5000	1	C				Performance +30
LOW BEAM, HIGH BEAM													
 	◆ D3S 4300 K	12/24	35 W	P32d-2	T3	3,200	4300	1	C		■		Standard
LOW BEAM, HIGH BEAM													
 	◆ D4S 4300 K	12/24	35 W	P32d-5	T2-3/4	2,800	4300	1	C				Standard
LOW BEAM, HIGH BEAM													

C = Box B = Blister Pack

P = Plastic Case

Measures in millimeters

* = OPTILUX Product Range

◆ = New Product

HELLA BULBS

BLISTER PACKS



HALOGEN SPECIAL BULBS

HELLA develops and manufactures light bulbs for the automotive industry and also has one of the largest retail organizations for auto parts. Our new range of blister packs lets you choose between different styles of light bulbs in a striking design for retail.



STANDARD

STANDARD

- 12 V and 24 V, double and individual blister
- Exclusive high-quality quartz crystal halogen gas formulation
- Original equipment quality
- Excellent luminous efficiency, quality / price
- Complies with global standards (ECE R37, SAE / DOT and INMETRO regulations)



PERFORMANCE

HELLA +50

- 12 V, double blister pack
- Up to 50% more light than standard HELLA bulbs
- Exclusive high-quality quartz crystal halogen gas formulation
- Meets global standards (ECE R37, SAE / DOT and INMETRO regulations).



PERFORMANCE

HIGH PERFORMANCE 2.0

- 12 V, double blister pack
- Up to 100% more light than standard HELLA bulbs
- Exclusive halogen gas and high quality quartz crystal formulation with blue coating
- Meets global standards (ECE R37, SAE / DOT and INMETRO regulations).



DESIGN

XTREME YELLOW

- Improved visibility under foggy, hail and rain conditions, due to its color temperature reduces reflection on objects
- 12 V - Double blister pack
- Exclusive high-quality halogen gas and quartz crystal formulation with yellow coating
- Recommended for vehicles in rural and off-road areas
- For off-road use.



HIGH WATTAGE

HIGH WATTAGE

- 12 V - double and single blister pack
- More light output compared to standard HELLA bulbs
- Excellent luminous efficiency, quality / price ratio
- For off-road use only



HEAVY DUTY

HEAVY DUTY / DOUBLE POWER

- 12 V and 24 V - Box, double and single blister pack
- Greater durability and resistance to vibrations compared to standard HELLA bulbs
- Heavy-duty bulbs offer more power and durability by reducing replacement times.





HELLA STANDARD - HALOGEN

HELLA Standard halogen lamps provide original equipment manufacturer quality and a great value for your money. DOT, ECE and inmetro certified*

Note: Please note that bulbs with too high of a wattage can cause the overheating of the wiring and damage to the headlight.

Features:

- Best mixture of light output and reliability
- Original equipment quality
- Excellent luminous efficiency.
- Excellent quality / price

HELLA STANDARD - HALOGEN 12 V

Double Blister Pack



Part Number	Type	Voltage	Wattage	Base	Content	Packaging
◆ 9003TB	9003/HB2	12 V	60/55 W	P43t	2	B
◆ 9004TB	9004/HB1	12 V	65/45 W	P29t	2	B
◆ 9005TB	9005/HB3	12 V	65 W	P20d	2	B
◆ 9006TB	9006/HB4	12 V	55 W	P22d	2	B
◆ 9007TB	9007/HB5	12 V	65/55 W	PX29t	2	B
◆ H1TB	H1	12 V	55 W	P14.5s	2	B
◆ H10TB	H10	12 V	45 W	PY20d	2	B
◆ H11TB	H11	12 V	55 W	PGJ19-2	2	B
◆ H13TB	H13	12 V	60/55 W	P26.4t	2	B
◆ H3TB	H3	12 V	55 W	PK22s	2	B
◆ H3 35WTB	H3	12 V	35 W	PK22s	2	B
◆ H4TB	H4	12 V	60/55 W	P43t	2	B
◆ H4 35/35WTB	H4	12 V	35/35 W	P43t	2	B
◆ H4 45/45WTB	H4	12 V	45/45 W	P43t	2	B
◆ H4 P45TTB	H4	12 V	60/55 W	P45t	2	B
◆ H7TB	H7	12 V	55 W	PX26d	2	B
◆ H8TB	H8	12 V	35 W	PGJ19-1	2	B
◆ H9TB	H9	12 V	65 W	PGJ19-5	2	B
◆ HS1TB	HS1	12 V	35/35 W	PX43t	2	B
◆ M5 35/35WTB	M5	12 V	35/35 W	P15d-25-1	2	B

Single Blister Pack



Part Number	Type	Voltage	Wattage	Base	Content	Packaging
◆ 9003SB	9003/HB2	12 V	60/55 W	P43t	1	B1
◆ 9004SB	9004/HB1	12 V	65/45 W	P29T	1	B1
◆ 9005SB	9005/HB3	12 V	65 W	P20d	1	B1
◆ 9006SB	9006/HB4	12 V	55 W	P22d	1	B1
◆ 9007SB	9007/HB5	12 V	65/55 W	PX29t	1	B1
◆ H1SB	H1	12 V	55 W	P14.5s	1	B1
◆ H10SB	H10/9145	12 V	45 W	PY20d	1	B1
◆ H11SB	H11	12 V	55 W	PGJ19-2	1	B1
◆ H13SB	H13	12 V	60/55 W	P26.4t	1	B1
◆ H3SB	H3	12 V	55 W	PK22s	1	B1
◆ H3 35WSB	H3	12 V	35 W	PK22s	1	B1
◆ H4SB	H4	12 V	60/55 W	P43T	1	B1
◆ H4 35/35WSB	H4	12 V	35/35 W	P43T	1	B1
◆ H4 45/45WSB	H4	12 V	45/45 W	P43T	1	B1
◆ H4 P45TSB	H4	12 V	60/55 W	P45t	1	B1
◆ H7SB	H7	12 V	55 W	PX26d	1	B1
◆ H8SB	H8	12 V	35 W	PGJ19-1	1	B1
◆ H9SB	H9	12 V	65 W	PGJ19-5	1	B1
◆ HS1SB	HS1	12 V	35/35 W	PX43t	1	B1
◆ M5 35/35WSB	M5	12 V	35/35 W	P15d-25-1	1	B1
◆ H16SB	H16	12 V	19 W	PGJ19-3	1	B1



HELLA STANDARD - MINIATURE BULBS

Miniature bulbs cover a wide range of mostly low voltage bulb types with unique shapes and bases. HELLA miniature bulbs are manufactured with precise lighting requirements to fit a wide variety of brake lamp, stop lamp, turn signal, and reverse lamp applications. DOT, ECE and inmetro certified*

Features:

- Fits a wide variety of applications
- Excellent luminous efficiency.
- Excellent quality / price

HELLA STANDARD MINIATURE:

Double Blister Pack.



Part Number	Type	Voltage	Wattage	Base	Content	Packaging
◆ 7506TB	7506	12 V	21 W	BA15s	2	B
◆ 1034TB	1034	12 V	23/8 W	BAY15D	2	B
◆ 2825TB	2825	12 V	5 W	W2.1x9.5d	2	B
◆ 7528TB	7528	12 V	21/5 W	BAY15d	2	B
◆ 921TB	921	12 V	16 W	W2.1x9.5d	2	B
◆ 7443TB	7443	12 V	21/5 W	W3X16q	2	B
◆ 158TB	158	12 V	3 W	W2.1x9.5d	2	B
◆ 5007TB	5007	12 V	5 W	BA15s	2	B
◆ 67TB	67	12 V	8 W	BA15s	2	B
◆ 3898TB	3898	12 V	2 W	BA7s	2	B
◆ 3157TB	3157	12 V	27/7 W	W2.5x16q	2	B
◆ 5008TB	5008	12 V	10 W	BA15s	2	B
◆ 5637TB	5637	24 V	10 W	BA15s	2	B
◆ 3893TB	3893	12 V	4 W	BA9s	2	B
◆ 7440TB	7440	12 V	21 W	W3X16d	2	B
◆ 7507TB	7507	12 V	21 W	BAU15s	2	B
◆ DE3175TB	3175	12 V	10 W	SV8.5-8	2	B
◆ 6411TB	6411	12 V	10 W	SV8.5-8	2	B
◆ 2721TB	2721	12 V	1.2 W	W2x4.6d	2	B
◆ 168TB	168	12 V	5 W	W2.1x9.5d	2	B

Single Blister Pack.



Part Number	Type	Voltage	Wattage	Base	Content	Packaging
◆ 73TB	73	12 V	1.1 W	W2.1x4.9d	2	B
◆ 53TB	53	12 V	2 W	BA9s	2	B
◆ 1157TB	1157	12 V	27/8 W	BA9s	2	B
◆ 7507CTB	7507C	12 V	21 W	BAU15S	2	B
◆ 1141TB	1141	12 V	18 W	BA15s	2	B
◆ 7506ATB	7506A	12 V	21 W	BA15s	2	B
◆ 6418TB	6418	12 V	5 W	SV8.5-8	2	B
◆ DE3021TB	3021	12 V	3 W	SV7-8	2	B
◆ 7225TB	7225	12 V	21/4 W	BAZ15d	2	B
◆ 2827NATB	2827NA	12 V	5 W	W2.1x9.5d	2	B
◆ 2821TB	2821	12 V	3 W	W2.1x9.5d	2	B
◆ 2825SB	2825	12 V	5 W	W2.1x9.5d	1	B1
◆ 7528SB	7528	12 V	21/5 W	BAY15d	1	B1
◆ 921SB	921	12 V	16 W	W2.1x9.5d	1	B1
◆ 5007SB	5007	12 V	5 W	BA15s	1	B1
◆ 5008SB	5008	12 V	10 W	BA15s	1	B1
◆ 3893SB	3893	12 V	4 W	BA9s	1	B1
◆ DE3175SB	3175	12 V	10 W	SV8.5-8	1	B1
◆ 6235SB	6235	12 V	35/35 W	BA20d	1	B1
◆ DE3021SB	3021	12 V	35/35 W	SV7-8	1	B1
◆ 2821SB	2821	12 V	3 W	W2.1x9.5d	1	B1



HELLA STANDARD - 24 V

In a convenient presentation, HELLA presents its range of 24 V products in plastic blister packs with the same Original Equipment quality in both halogen bulbs and miniature bulbs.

Features:

- Double blister pack and single blister
- Original equipment quality
- Excellent luminous efficiency. Excellent quality / price
- Meets global standards (ECE R37, SAE / DOT and INMETRO)

HELLA STANDARD 24 V:

Double Blister Pack.



Part Number	Type	Voltage	Wattage	Base	Content	Packaging
◆ 1141 24VTB	1141	24 V	18 W	BA15s	2	B
◆ 2741TB	2741	24 V	1.2 W	W2x4.6d	2	B
◆ 2841TB	2841	24 V	3 W	W2.1x9.5d	2	B
◆ 2845TB	2845	24 V	5 W	W2.1x9.5d	2	B
◆ 3797TB	3797	24 V	2 W	BA9s	2	B
◆ 3930TB	3930	24 V	4 W	BA9s	2	B
◆ 5627TB	5627	24 V	5 W	BA15s	2	B
◆ 6423TB	6423	24 V	5 W	SV8.5-8	2	B
◆ 6429TB	6429	24 V	10 W	SV8.5-8	2	B
◆ 7510LTSTB	7510LTS	24 V	21 W	BAU15s	2	B
◆ 7511TB	7511	24 V	21 W	BA15s	2	B
◆ 7534TB	7534	24 V	21/5 W	BA15d	2	B
◆ 7537TB	7537	24 V	21/5 W	BAY15d	2	B
◆ 7952TB	7952	24 V	55/50 W	P45t	2	B
◆ 9507TB	9507	24 V	21 W	BAU15s	2	B
◆ H1 24VTB	H1	24 V	70 W	P14.5s	2	B
◆ H11 24VTB	H11	24 V	70 W	PGJ19-2	2	B
◆ H3 24VTB	H3	24 V	70 W	PK22s	2	B
◆ H4 24VTB	H4	24 V	75/70 W	P43t	2	B
◆ H7 24VTB	H7	24 V	70 W	PX26d	2	B
◆ H9 24VTB	H9	24 V	80 W	PGJ19-5	2	B

Single Blister Pack.



Part Number	Type	Voltage	Wattage	Base	Content	Packaging
◆ 1141 24VSB	1141	24 V	18 W	BA15s	1	B1
◆ 2845SB	2845	24 V	5 W	W2.1x9.5d	1	B1
◆ 5627SB	5627	24 V	5 W	BA15s	1	B1
◆ 7511SB	7511	24 V	21 W	BA15s	1	B1
◆ 7537SB	7537	24 V	21/5 W	BAY15d	1	B1
◆ H1 24VSB	H1	24 V	70 W	P14.5s	1	B1
◆ H11 24VSB	H11	24 V	70 W	PGJ19-2	1	B1
◆ H3 24VSB	H3	24 V	70 W	PK22s	1	B1
◆ H4 24VSB	H4	24 V	75/70 W	P43t	1	B1
◆ H7 24VSB	H7	24 V	70 W	PX26d	1	B1
◆ H9 24VSB	H9	24 V	80 W	PGJ19-5	1	B1



LONG LIFE

The special design of Long Life bulbs for passenger cars guarantees a longer service life, more light performance and reduced energy consumption, making them ideal for frequent drivers and permanent use of daytime running lights. Long Life represents bright but glare-free light. Good performance under extreme conditions for construction machinery or off-road vehicles.

Long Life combines unusual sturdiness and vibration resistance with convincing brightness and long service life.

Features:

- Up to 200% longer life time than HELLA standard bulbs.
- Special mixture of halogen gases to achieve high durability and increase life time
- Meets global standard (ECE R37 & SAE/DOT regulation).
- Color temperature 3,200 K

Some examples of the product range:



H4 24LL



H13LL

HELLA LONG LIFE:

Part Number	Type	Voltage	Wattage	Base	Shape	Luminous Flux (lumens)	Content	Packaging	DOT	ECE	INMETRO
H1LL	H1	12 V	55 W	P14.5s	T2.5	1550	1	C	■	■	■
◆ H4 24V LL	H4	24 V	75/70 W	P43t	T4.625	1900/1200	1	C	■	■	■
◆ H7 24V LL	H7	24 V	70 W	PX26d	T4.625	1750	1	C	■	■	■
◆ H7LL	H7	12 V	55 W	PX26d	T4.625	1500	1	C	■	■	■
H11LL	H11	12 V	55 W	PGJ19-2	T4	1350	1	C	■	■	■
9003LL	9003	12 V	60/55 W	P43t	T4.625	1500/910	1	C	■	■	■
9004LL	9004	12 V	65/45 W	P29t	T4.625	1200/700	1	C	■	■	■
9005LL	9005	12 V	65 W	P20d	T4	1860	1	C	■	■	■
◆ 9006LL	9006	12 V	55 W	P22d	T4	1095	1	C	■	■	■
9007LL	9007	12 V	65/55 W	PX29t	T4.625	1350/1000	1	C	■	■	■
1003LL	1003	12 V	12 W	BA15s	B6		1	C	■	■	■
1141LL	1141	12 V	18 W	BA15s	S8		1	C	■	■	■
1156LL	1156	12 V	27 W	BA15s	S8		1	C	■	■	■
1157LL	1157	12 V	27/8 W	BAY15d	S8		1	C	■	■	■
2057LL	2057	12 V	27/7 W	BAY15d	S8		1	C	■	■	■
2057NALL	2057	12 V	27/7 W	BAY15d	S8		1	C	■	■	■
2357LL	2357	12 V	29/8 W	BAY15d	S8		1	C	■	■	■
3047LL	3047	12 V	21/7 W	W2.5X16q	S8		1	C	■	■	■
3157LL	3157	12 V	27/7 W	W2.5x16q	S8		1	C	■	■	■
7440LL	7440	12 V	21 W	W3X16d	T6.5		1	C	■	■	■
7443LL	7443	12 V	21/5 W	W3X16q	T6.5		1	C	■	■	■
◆ 9012LL	9012	12 V	55 W	PX22d	T4		1	C	■	■	■



HIGH PERFORMANCE 2.0

HELLA's HP 2.0 Bulbs have been re-engineered to produce a brighter, whiter light which allows the driver to see more contrast in objects on the road, increasing safety and reaction time. These DOT compliant bulbs have been manufactured under strict HELLA guidelines and are an optimal balance of bulb performance and bulb life. The new HP 2.0 kits contain everything you need to get the job done.

Features:

- 12 V - Double Blister Pack
- Up to 100% more light than HELLA standard bulbs
- Meets global standard (ECE R37 & SAE/DOT and INMETRO regulation).
- Specially designed by halogen mixing gas & filament.
- Color temperature: 3,600 K



HELLA HIGH PERFORMANCE 2.0:

Part Number	Type	Voltage	Wattage	Base	Content	Packaging	DOT	ECE	INMETRO
◆ H1 2.0TB	H1	12 V	55 W	P14.5s	2	B	■	■	007691/2013
◆ H3 2.0TB	H3	12 V	55 W	PK22s	2	B	■	■	007696/2013
◆ 9003 2.0TB	H4 HB2 9003	12 V	60/55 W	P43t	2	B	■	■	007697/2013
◆ H7 2.0TB	H7 12V	12 V	55 W	PX26d	2	B	■	■	007698/2013
◆ H9 2.0TB	H9 12V	12 V	65 W	PGJ19-5	2	B	■	■	-
◆ H11 2.0TB	H11 12V	12 V	55 W	PGJ19-2	2	B	■	■	-
◆ H13 2.0TB	H13 9008	12 V	60/55 W	P26.4t	2	B	■	■	-
◆ 9004 2.0TB	9004 HB1	12 V	65/45W	P29t	2	B	■	■	007699/2013
◆ 9005 2.0TB	9005 HB3	12 V	65 W	P20d	2	B	■	■	007700/2013
◆ 9006 2.0TB	9006 HB4	12 V	55 W	P22d	2	B	■	■	007701/2013
◆ 9007 2.0TB	9007 HB5	12 V	65/55W	PX29t	2	B	■	■	-



Re-engineered filament for greater light output

High quality quartz glass with a specialized blue coating

Exclusive halogen gas formulation for improved performance



HELLA +50

The HELLA +50 version produces 50 percent more light (compared to standard bulbs*) and extends the light cone, giving performance-oriented drivers additional safety time in case of an emergency situation.

Features:

- Up to 50% more light output than HELLA standard bulbs
- Meets global standard (ECE R37 & SAE/ DOT and INMETRO regulation).
- Filament design optimized
- Wider and brighter light
- OE quality
- With silver top coating to be invisible in the headlight

Some examples of the product range:

HELLA +50:

Part Number	Type	Voltage	Wattage	Base	Shape	Luminous Flux (lumens)	Content	Packaging	DOT	ECE	INMETRO
H1P50	H1	12 V	55 W	P14.5s	T2.5	1700	1	C	■	■	■
◆ H1P50TB	H1	12 V	55 W	P14.5s	T2.5	1700	2	B	■	■	■
H3P50	H3	12 V	55 W	PK22s	T3.25	1600	1	C	■	■	■
◆ H3P50TB	H3	12 V	55 W	PK22s	T3.25	1600	2	B	■	■	■
H4P50	H4	12 V	60/55 W	P43t	T4.625	1815/1100	1	C		■	■
◆ H4P50TB	H4	12 V	60/55 W	P43t	T4.625	1815/1100	2	B		■	■
H7P50	H7	12 V	55 W	PX26d	T4.625	1560	1	C	■	■	■
◆ H7P50TB	H7	12 V	55 W	PX26d	T4.625	1560	2	B	■	■	■
H11P50	H11	12 V	55 W	PGJ19-2	T4	1450	1	C	■	■	
◆ H11P50TB	H11	12 V	55 W	PGJ19-2	T4	1450	2	B	■	■	
H13P50	H13	12 V	60/55 W	P26.4t	T4	1650/1100	1	C	■	■	
◆ H13P50TB	H13	12 V	60/55 W	P26.4t	T4	1650/1100	2	B	■	■	
9004P50	9004	12 V	65/45 W	P29t	T4.625	1250/765	1	C	■		■
◆ 9004P50TB	9004	12 V	65/45 W	P29t	T4.625	1250/765	2	B	■		■
9005P50	9005	12 V	65 W	P20d	T4	2000	1	C	■	■	■
◆ 9005P50TB	9005	12 V	65 W	P20d	T4	2000	2	B	■	■	■
9006P50	9006	12 V	55 W	P22d	T4	1200	1	C	■	■	■
◆ 9006P50TB	9006	12 V	55 W	P22d	T4	1200	2	B	■	■	■
9007P50	9007	12 V	65/55 W	PX29t	T4.625	1450	1	C	■		
◆ 9007P50TB	9007	12 V	65/55 W	PX29t	T4.625	1450	2	B	■		



H4P50



H13P50



HIGH WATTAGE

The ideal bulbs for professionals who travel off-road, or have a special demand for high power. Such as those in agriculture or forestry, or on building sites. In addition, HELLA bulbs have been involved in many victories in 24-hour races.

Note: Please note that bulbs with too high of a wattage can cause the overheating of the wiring and damage to the headlight.

Features:

- Box, double and single blister pack
- Longer service life compared to standard HELLA bulbs
- Environmentally friendly, because they do not have to be replaced as often.
- Excellent luminous efficiency.
- Excellent quality / price
- For off-road use only

Some examples of the product range:

HELLA HIGH WATTAGE:

Part Number	Type	Voltage	Wattage	Base	Shape	Luminous Flux (lumens)	Content	Packaging	DOT	ECE	INMETRO
H1 100W	H1	12 V	100 W	P14.5s	T2.5	1850	1	C			
◆ H1 100WTB	H1	12 V	100 W	P14.5s	T2.5	1850	2	B			
H1 130W	H1	12 V	130 W	P14.5s	T2.5	2400	1	C			
H2 100W	H2	12 V	100 W	X511	T3		1	C			
H3 100W	H3	12 V	100 W	PK22s	T3.25	1850	1	C			
◆ H3 100WTB	H3	12 V	100 W	PK22s	T3.25	1850	2	B			
H3 130W	H3	12 V	130 W	PK22s	T3.25	2600	1	C			
◆ H3 130WTB	H3	12 V	130 W	PK22s	T3.25	2600	2	B			
H3 24V 100W	H3	24 V	100 W	PK22s	T3.25	2500	1	C			
H4 100/55W	H4	12 V	100/55 W	P43t	T4.625	2400/1000	1	C			
◆ H4 100/55WTB	H4	12 V	100/55 W	P43t	T4.625	2400/1000	2	B			
H4 100/80W	H4	12 V	100/80 W	P43t	T4.625		1	C			
◆ H4 100/80WTB	H4	12 V	100/80 W	P43t	T4.625		2	B			
◆ H4 130/90W	H4	12 V	130/90 W	P43t	T4.625	3200/1600	1	C			
◆ H4 130/90WTB	H4	12 V	130/90 W	P43t	T4.625	3200/1600	2	B			
H4 24V 100/90W	H4	24 V	100/90 W	P43t	T4.625		1	C			
H7 100W	H7	12 V	100 W	PX26d	T4.625	2000	1	C			
◆ H7 100WTB	H7	12 V	100 W	PX26d	T4.625	2000	2	B			
H7 70W	H7	12 V	70 W	PX26d	T4.625	1800	1	C			
9004 100/80W	9004	12 V	100/80 W	P29t	T4.625	1600/1300	1	C			
9005 100W	9005	12 V	100 W	P20d	T4	2200	1	C			
9006 80W	9006	12 V	80 W	P22d	T4	1650	1	C			
9007 100/80W	9007	12 V	100/80 W	PX29t	T4.625	1800/1500	1	C			
◆ H4 100/80WSB	H4	12 V	100/80 W	P43t	T4.625		1	B1			
◆ 9007 100/80WSB	9007	12 V	100/80 W	PX29t	T4.625	1800/1500	1	B1			
◆ 9004 100/80WSB	9004	12 V	100/80 W	P29t	T4.625	1600/1300	1	B1			
◆ 9006 80WSB	9006	12 V	80 W	P22d	T4	1650	1	B1			
◆ 9005 100WSB	9005	12 V	100 W	P20d	T4	2200	1	B1			



9005 100W



9004 100/80W



HEAVY DUTY | DOUBLE POWER

Durability, resistance to vibration with 24V power produces excellent light in a single filament. Heavy Duty bulbs offer more power, more safety, without dazzling vehicles. Thanks to its power and increased lifespan, the replacement costs are reduced drastically.

Features:

- Increased vibration resistance
- All advantages of standard bulbs
- Reduced downtime cost due to less bulb changes

Some examples of the product range:

HELLA HEAVY DUTY:

Part Number	Type	Voltage	Wattage	Base	Shape	Luminous Flux (lumens)	Content	Packaging	DOT	ECE	INMETRO
198HD	198	12 V	29/10 W	BAY15d	S8		10	C	■		
5637HD	5637	24 V	10 W	BA15s	B6		10	C		■	■
7510LTS	PY21W	24 V	21 W	BAU15s	S8		10	C			
H3 24V HD	H3	24 V	70 W	PK22s	T3.25	1750	1	C		■	■
H3HD	H3	12 V	55 W	PK22s	T3.25	1450	1	C	■	■	■
◆ H3 24V HDSB	H3	24 V	70 W	P43t	T3.25	1900/1200	1	B		■	■
◆ H3 24V HDTB	H3	24 V	70 W	P43t	T3.25		2	B		■	■
H4 24V HD	H4	24 V	75/70 W	PK22s	T4.625		1	C		■	■
◆ H4 24V HDSB	H4	24 V	75/70 W	PK22s	T4.625		1	B		■	■
◆ H4 24V HDTB	H4	24 V	75/70 W	PK22s	T4.625		2	B		■	■



H4 24V HD

HELLA DOUBLE POWER:

◆ H1 24V DP	H1	24 V	70 W	P14.5s	T2.5		1	C		■	■
◆ H3 24V DP	H3	24 V	70 W	PK22s	T3.25		1	C		■	■
◆ H4 24V DP	H4	24 V	70/75 W	P43t	T4.625		1	C		■	■
◆ H7 24V DP	H7	24 V	70 W	PX26d	T4.625		1	C		■	■
◆ H11 24V DP	H11	24 V	70 W	PGJ19-2	T4		1	C		■	
◆ H1 24V DPSB		24 V	70 W	P14.5s	T2.5		1	B		■	■
◆ H3 24V DPSB		24 V	70 W	PK22s	T3.25		1	B		■	■
◆ H4 24V DPSB		24 V	75/70 W	P43t	T4.625		1	B		■	■
◆ H7 24V DPSB		24 V	70 W	PX26d	T4.625		1	B		■	■
◆ H11 24V DPSB		24 V	70 W	PGJ19-2	T4		1	B		■	



H3HD



OPTILUX EXTREME YELLOW XY - 12V

The XY Optilux bulbs are designed to give better visibility in extreme weather conditions. Pilots races prefer a yellow light beam, which provides better color contrast in rain and fog situations. The XY Optilux bulbs produce a clear yellow light their filament is made of specific measures to provide the exact amount of light needed in the way.

Features:

- All bulbs are Optilux 12V.
- Two bulbs packed in hard plastic.
- For off-road use

Some examples of the product range:



Part Number	Type	Voltage	Wattage	Base
H71071172	880	12V	27 W	PG13
H71071182	881	12V	27 W	PGJ13
◆ H71071192	893	12V	37.5 W	PG13
◆ H71071462	9006	12V	55 W	P22d**
H71071532	9011	12V	65 W	PX20d
H71071542	9012	12V	55 W	PX22d
H71070642	H1	12V	55 W	P14.5s
◆ H71071112	H10	12V	42 W	PY20d
H71071132	H11	12V	55 W	PGJ19-2
H71071552	H11B	12V	65W	PGJY19-2
H71071152	H13	12V	60/55 W	P26.4t
H71071302	H16	12V	35 W	PG20-3
H71070662	H3	12V	55 W	PK22s
H71071342	H3C	12V	55 W	P22d
H71070682	H4/9003	12V	60/55 W	P43t
H71070702	H7	12V	55 W	PX26d
H71071072	H8	12V	35 W	PGJ19-1
H71071092	H9	12V	65 W	PGJ19-5
H71070562	HB1	12V	65/45 W	P29t
H71070582	HB3	12V	65 W	P20d
H71070602	HB4	12V	55 W	P22d
H71070622	HB5	12V	60/55 W	PX29t



OPTILUX EXTREME WHITE XB - 12V

See the light!

Extreme White bulbs XB Optilux give a radical look at the xenon light in a halogen bulb, with its blue coating. These bulbs incorporate gas xenon bulb improved performance

Features:

- All bulbs are Optilux 12V.
- Two bulbs packed in hard plastic.
- For off-road use



Part Number	Type	Voltage	Wattage	Base	Part Number	Type	Voltage	Wattage	Base
H71071212	880	12V	32 W	PG13	◆ H71071052	H13	12V	100/80 W	P26.4t
H71071222	881	12V	32 W	PGJ13	H71071272	H13	12V	60/55 W	P26.4t
H71071232	893	12V	37.5 W	PG13	H71071282	H16	12V	35 W	PG20-3
H71071392	9004	12V	65/45 W	P29t	H71070227	H2	12V	100 W	P14.5s
H71071402	9005	12V	65 W	P20d	H71070181	H3	12V	100 W	PK22s
H71071412	9005	12V	65 W	P20d**	H71071312	H3	12V	55 W	PK22s
H71071422	9005	12V	100 W	P20d**	H71071322	H3C	12V	55 W	P22d
H71071432	9006	12V	55 W	P22d	H71071332	H3C	12V	80 W	P22d
H71071442	9006	12V	55 W	P22d**	H71070201	H4/9003	12V	100/80 W	P43t
H71071452	9006	12V	80 W	P22d**	H71071352	H4/9003	12V	60/55 W	P43t
H71071472	9007	12V	65/55 W	PX29t	H71070307	H7	12V	100 W	PX26d
◆ H71071492	9011	12V	65 W	PX20d	H71071362	H7	12V	55 W	PX26d
◆ H71071502	9012	12V	55 W	PX22d	H71070772	H8	12V	55 W	PGJ19-1
H71071242	H1	12V	55 W	P14.5s	H71071372	H8	12V	35 W	PGJ19-1
H71071012	H10	12V	65 W	PY20d	H71070792	H9	12V	100 W	PGJ19-5
H71071252	H10	12V	42 W	PY20d	H71071382	H9	12V	65 W	PGJ19-5
H71071032	H11	12V	80 W	PGJ19-2	H71070327	HB1	12V	100/80 W	P29t
H71071262	H11	12V	55 W	PGJ19-2	H71070347	HB3	12V	100 W	P20d
H71071512	H11B	12V	65W	PGJY19-2	H71070367	HB4	12V	80 W	P22d
					H71070387	HB5	12V	100/80 W	PX29t



LIGHT UP YOUR BUSINESS

TWO WHEELS

A dramatic sunset scene over a runway. The sky is filled with vibrant orange, red, and purple clouds. In the foreground, a motorcycle rider is silhouetted against the bright sun on the left. The runway stretches into the distance, lined with several vintage biplanes. The overall mood is one of adventure and speed.

S
ELERS



1 FRONT LIGHT LOW BEAM HIGH BEAM

HS1	H3 35W	H8 H8XE-DB	H4 35/35W M H4 60/55W M	H7
H9	H11 H11P50 H11LL	H21W	M5 18/18W M5 35/35W	M5 25/25W1
6235	M5 25/25W3	M5 35/35W3	M5 35/35W1	M5 25/25W

2 SIGNAL LIGHT FRONT REAR

H21W	921 W16W	2821	2825 W5W	7440 W21W	7440NA WY21W	7443
1891	5007 R5W	5008 R10W	5009A R10W	7506 P21W	7528 P21/5W	7507 PY21W

3 FRONTAL PARKING LIGHT

3893 T4W	5007 R5W	5008 R10W	H6W	194 W3W	2845 W5W	921 W16W

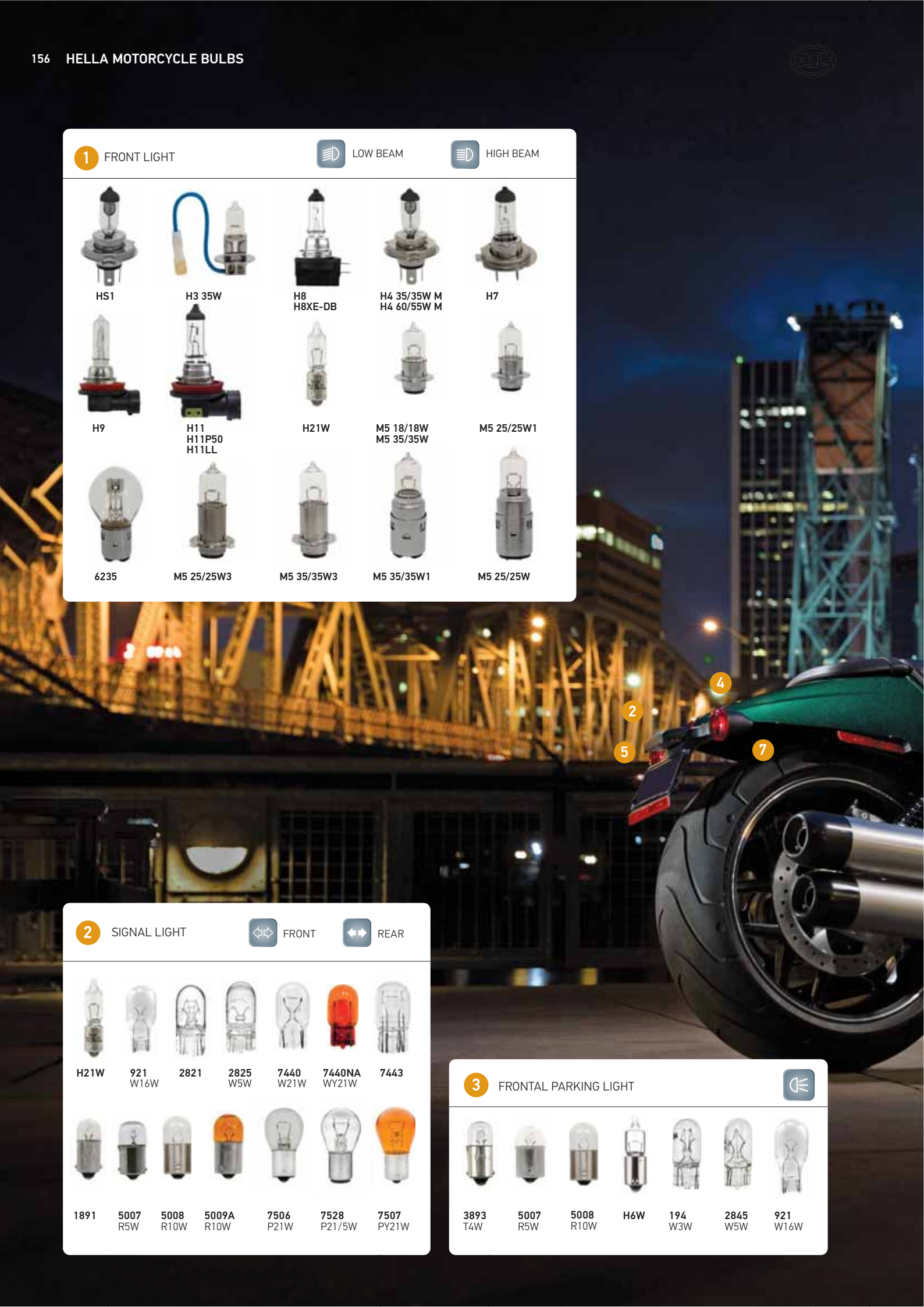

4 STOP LIGHT 











				
7528 P21/5W	7506 P21W	921 W16W	7443 W21/5W	5007 R5W

5 LICENSE PLATE LIGHT 

						
6413 C5W	H6W	5007 R5W	194 W3W	2825 W5W	5008 R10W	3893 T4W



7 POSITION LIGHT 

													
7528 P21/5W	7507	2721	3796	DE3175	6413	7537 P21/5W	7506 P21W	7443 W21/5W	194 W3W	2845 W5W	3893 T4W	5007 R5W	5008 R10W



HELLA has the most complete line of lighting for cars, trucks, buses and now for motorcycles, scooters, mopeds and ATVs.

As original equipment, HELLA is found in most of the car manufacturers, this means that we guarantee 100% light according to the technical standards, offering a long life and in perfect harmony with the whole vehicle. In addition, HELLA halogen bulbs have a UV filter that protects the headlight lens by blocking UV rays, which prevents yellowing of the lens.

BULBS FOR MOTORCYCLES



BULBS FOR MOTORCYCLES

For the wide range of motorcycles, scooters, mopeds and ATVs, HELLA offers precise solutions according to the requirements of original equipment.

Because it is particularly important for drivers of two-wheel vehicles to see and be seen...

Note:

In headlights, particularly in the case of motorcycles large motor or large displacement is common to find halogen bulbs with identical specification to those of automotive application (H4 60/55, H7 55W, 9006 55W, 9006 HXS 55W, etc.)



Part Number	Type	Voltage	Wattage	Base	Shape	Luminous Flux (lumens)	Content	Packaging	DOT	ECE	INMETRO
880XE-35DB	880	12 V	35 W	PG13	T3.25		1	C			
889XE-35DB	894	12 V	35 W	PGJ13	T3.25		1	C			
H3 35W	H3	12 V	35 W	PK22s	T3.25		1	C			
H8	H8	12 V	35 W	PGJ19-1	T4		1	C	■	■	
H8XE-DB	H8	12 V	35 W	PGJ19-1	T4		1	C			
HS1	HS1	12 V	35 / 35 W	PX43t	T4.625		1	C		■	
H4 35/35W	H4	12 V	35/35 W	P43t	T4.625		1	C			
H4 45/45W	H4	12 V	45/45 W	P43t	T4.625		1	C			
6235	S2	12 V	35/35 W	BA20d	B11		1	C			■
6245	S2	12 V	45/40 W	BA20d	B11		1	C			
A3603	3603	12 V	25/25 W	PX15d	T6		1	C			
6260	S2	12 V	60/60 W	BA20d	B11		1	C			
A3625	3625	6 V	25/25 W	PX15d	T6		1	C			
635	F2	12 V	35 W	BA20s	B11		1	C			
660	660	12 V	60 W	BA20s	B11		1	C			
7951	R2	12 V	45/40 W	P45t	S13		1	C			
7952	R2	24 V	55/50 W	P45t	S13		1	C			
H9	H9	12 V	65 W	PGJ19-5	T4		1	C	■	■	
H11	H11	12 V	55 W	PGJ19-2	T4		1	C	■	■	
H11P50	H11	12 V	55 W	PGJ19-2	T4		1	C	■	■	
H11LL	H11	12 V	55 W	PGJ19-2	T4		1	C	■	■	
H21W	H21W	12 V	21 W	BAV9s	T2.75		1	C		■	■
H6W	H6W	12 V	6 W	BAX9s	T2.75		1	C		■	
2820	2820	12 V	2 W	W2.1x9.5d	T3.25		10	C			
2821	2821	12 V	3 W	W2.1x9.5d	T3.25		10	C		■	■
2825	2825	12 V	5 W	W2.1x9.5d	T3.25		10	C		■	■
2825BL	2825BL	12 V	5 W	W2.1x9.5d	T3.25		10	C			
2827NA	2827NA	12 V	5 W	W2.1x9.5d	T3.25		10	C			
3652	3652	12 V	5 W	W2.1x9.5d	T3.25		10	C		■	■
7440	7440	12 V	21 W	W3X16d	T6.5		10	C	■	■	■
7440LL	7440	12 V	21 W	W3X16d	T6.5		10	C	■	■	■
7440NA	7440	12 V	21 W	W3X16d	T6.5		10	C	■	■	■
7441	7441	12 V	27 W	W3X16d	T6.5		10	C	■		
3893	3893	12 V	4 W	BA9s	T2.75		10	C	■	■	
194	194	12 V	4 W	W2.1x9.5d	T3.25		10	C	■		
194NA	194	12 V	4 W	W2.1x9.5d	T3.25		10	C	■		
7507C	7507	12 V	21 W	BAU15s	S8		10	C			
7507	7507	12 V	21 W	BAU15s	S8		10	C		■	■
2721	2721	12 V	1.2 W	W2x4.6d	T1.5		10	C	■		■
◆ M5 35/35W	M5	12 V	35/35 W	P15d-25-1		840/805	1	C			
◆ M5 35/35WTB	M5	12 V	35/35 W	P15d-25-1		840/805	2	B			
◆ M5 35/35WSB	M5	12 V	35/35 W	P15d-25-1		840/805	1	B			
◆ M5 35/35W1	M5	12 V	35/35 W	BA20D		840/805	1	C	■		
◆ M5 25/25W	M5	12 V	25/25 W	BA20D		540/540	1	C	■		
◆ M5 25/25W1	M5	12 V	25/25 W	P15D-25-1		540/540	1	C	■		
◆ M5 18/18W	M5	12 V	18/18 W	P15D-25-1		440/440	1	C	■		
◆ M5 35/35W3	M5	12 V	35/35 W	P15D-25-3		840/805	1	C	■		
◆ M5 25/25W3	M5	12 V	25/25 W	P15D-25-3		540/540	1	C	■		

Some examples of the product range:



6235



660



7951



ADDITIONAL INFORMATION



Displays



Pre-stocked bulb display

Ask your sales representative for the new HELLA displays and get them now!

- Metal frame with 4 shelves and acrylic window
- Shelving is adjustable inside the cabinet
- Durable and elegant design
- Contents: H7 (24 packs), H3 24V (4 packs), 9003 (6 packs), H11 (4 packs), H1 (4 packs), H3 (4 packs), 2 boxes of 10 pcs of the following bulbs: 3157, 194, 7506, 921, 3898

Part Number	Description
999942461	Pre-stocked bulb display. Dimensions: 44.5x 17.5x 54 cm (17.5 x 6.88 x 21.2")

Bulbs cabinet for miniature bulbs

Ask your sales representative for the new HELLA displays and get them now!

- Manufactured in semi-matt black steel.
- Its compartments come in stackable and individual shapes to maximize organization.
- The miniature bulb dispenser cabinet includes 4 plastic drawers, dividers to make 28 slots for light bulbs
- Storage space "behind" the label
- Durable and elegant design



Part Number	Description
999141848	Cabinet Display. Dimensions: 48.2 x 10.1 x 68.5 cm (18.97 x 3.97 x 26.9")

Blister display

- Manufactured in semi-matt black steel.
- Its 8 hooks allow you to hang up to 40 blisters in total.

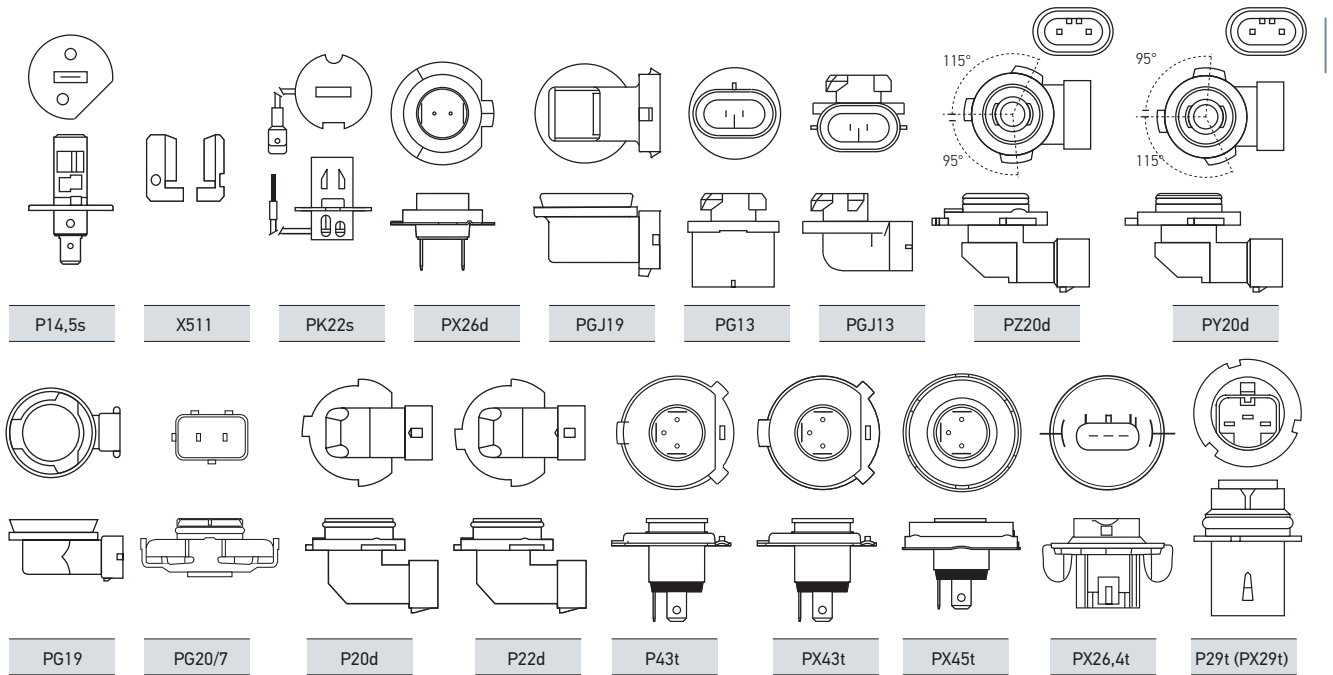
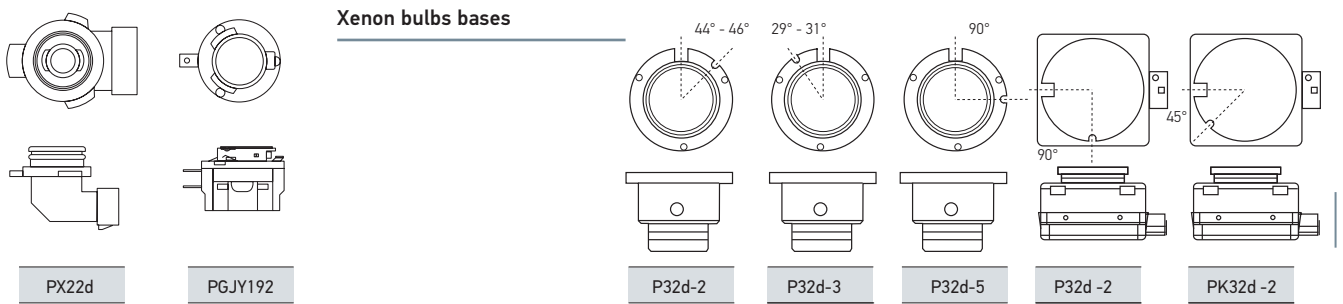
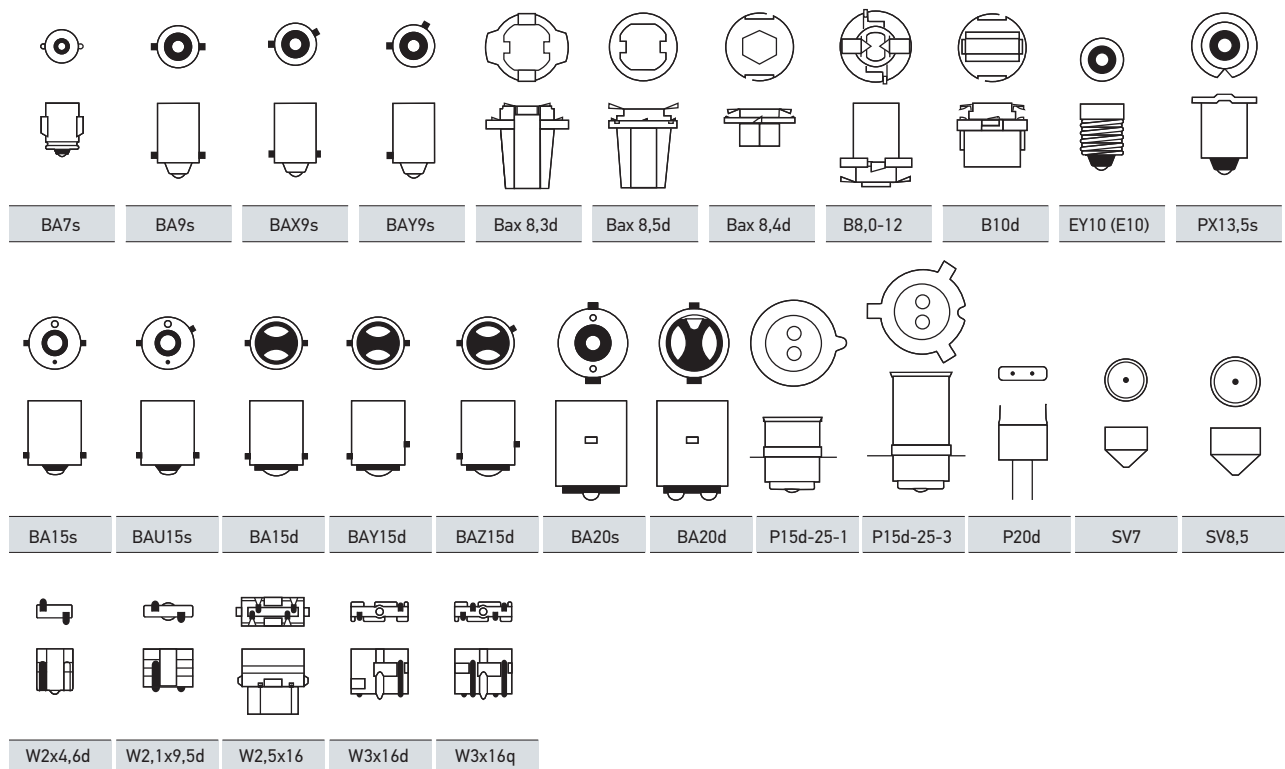

Part Number	Description
999942713	Hanging blister display.
999942615	Counter top blister display. Dimensions: 52 x 22 x 55.5 cm (20.47 x 8.66 x 21.85")

Halogen bulbs bases

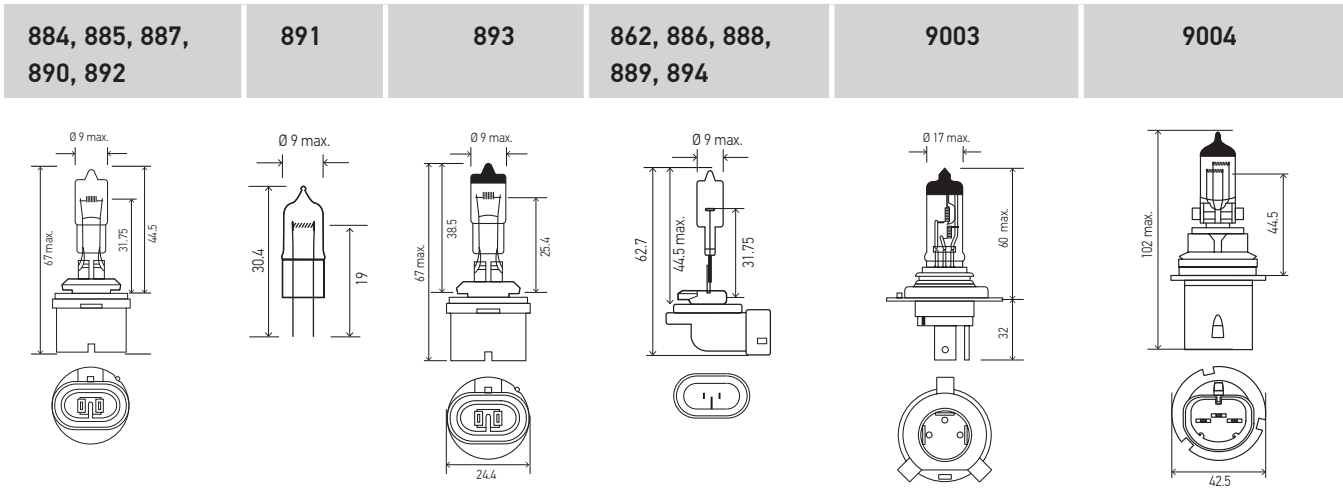
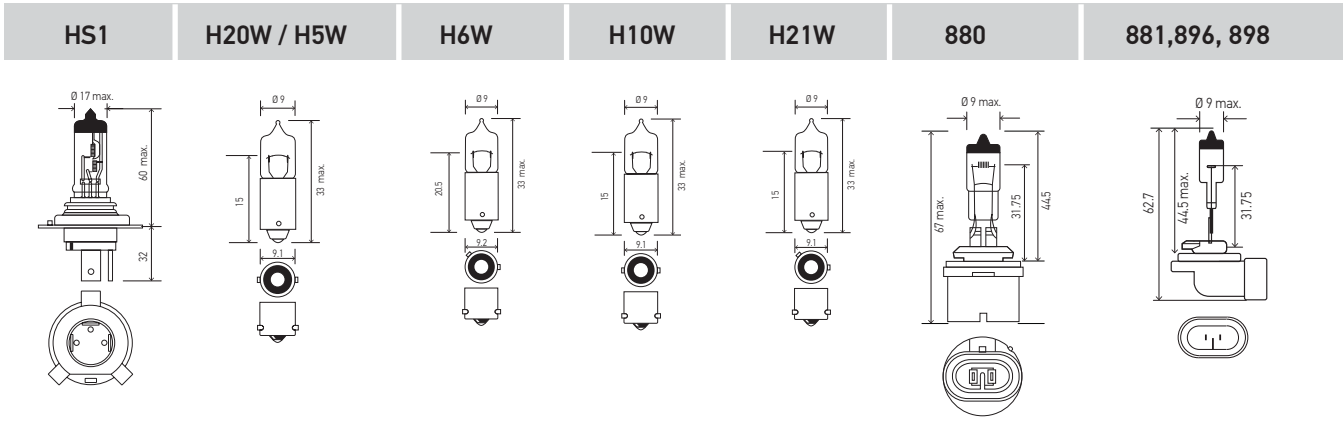
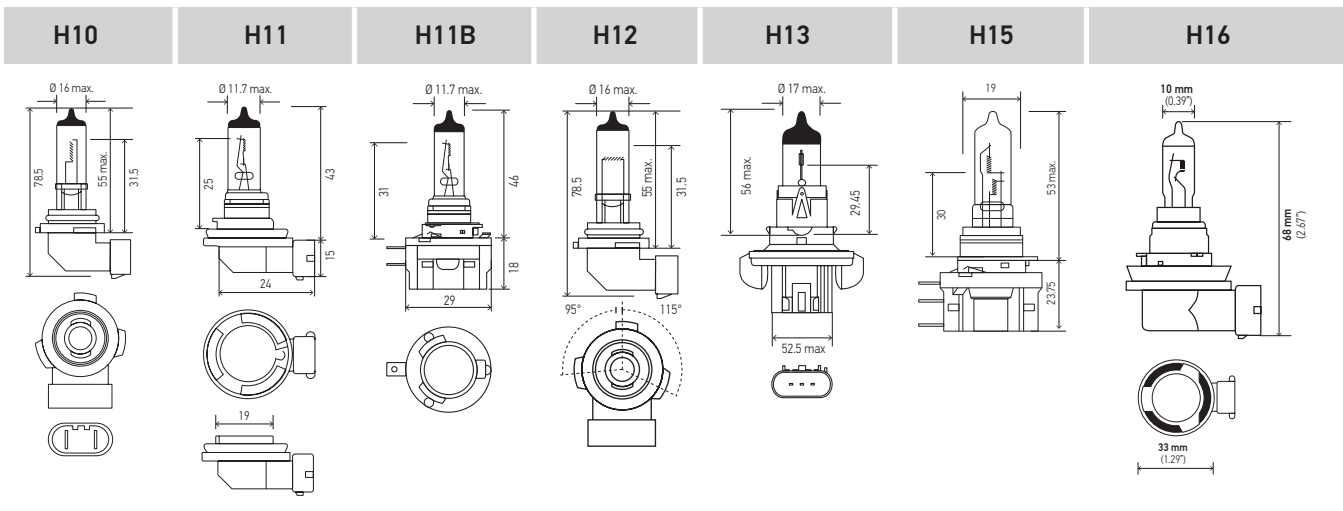
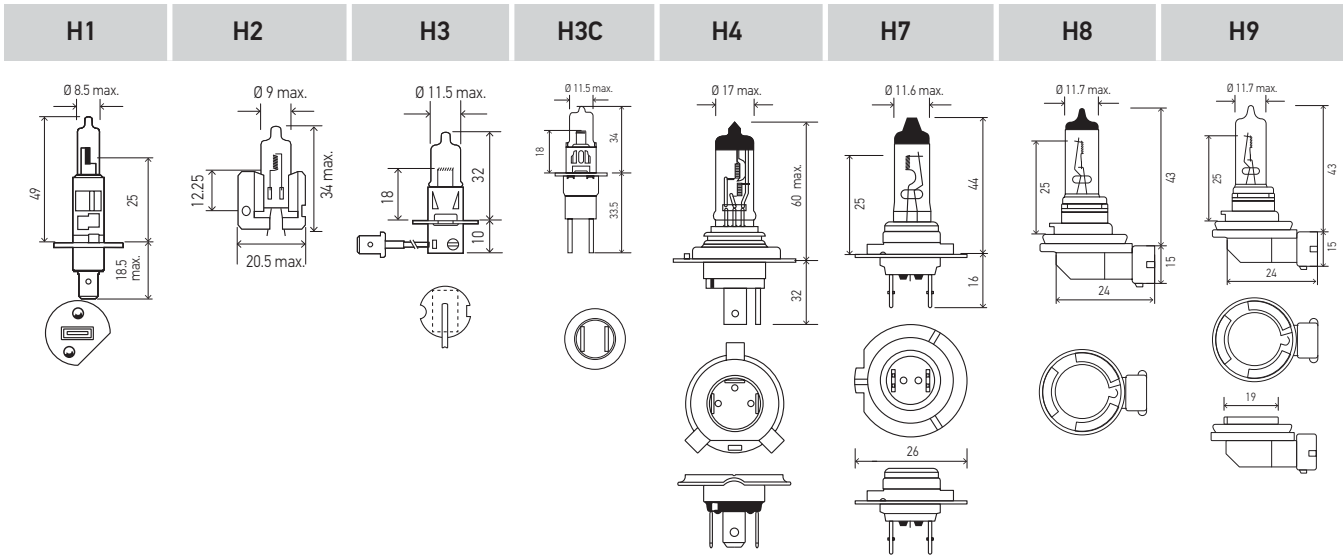
Xenon bulbs bases

Miniature bulbs bases



9005	9005XS	9006	9006XS	9007	HIR2 / 9012	9009S

M5	BA15d	BA15d	BA15d	BA15s	BA15s	BA15s	BA15s

BA15s P21W / PY21W	BA20d S2	BA20s	BA7s	BA9s	BA9s	BA9s	BA9s

BAU15s P21W/PY21W	BAY15d	BAY15d	BAY15d	BAZ15d	G4	P45t / R2



PX15d	SV7-8	SV7-8	SV8.5-8	SV8.5-8	SV8.5-8 / C5W	W2.1x4.9d
-------	-------	-------	---------	---------	---------------	-----------

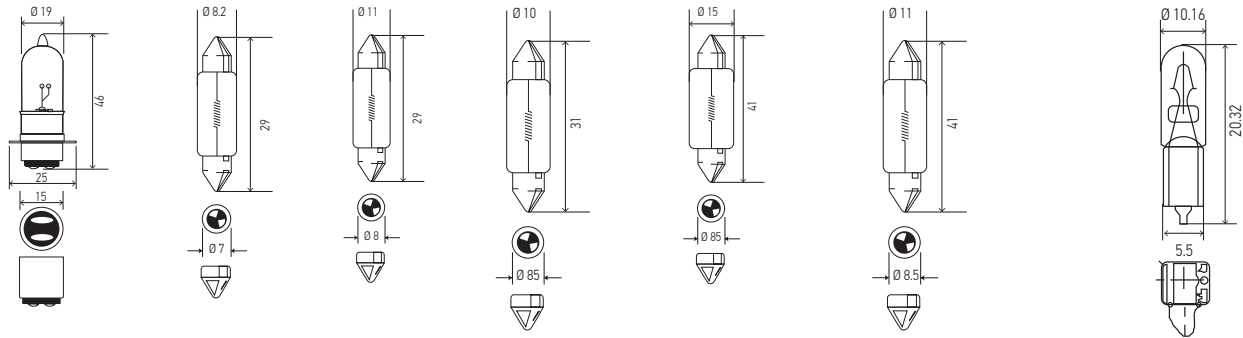

W2.1x9.5d	W2.1x9.5d	W2.1x9.5d	W2.5x16d	W2x4.6d	W2x4.6d	W2x4.6d
-----------	-----------	-----------	----------	---------	---------	---------

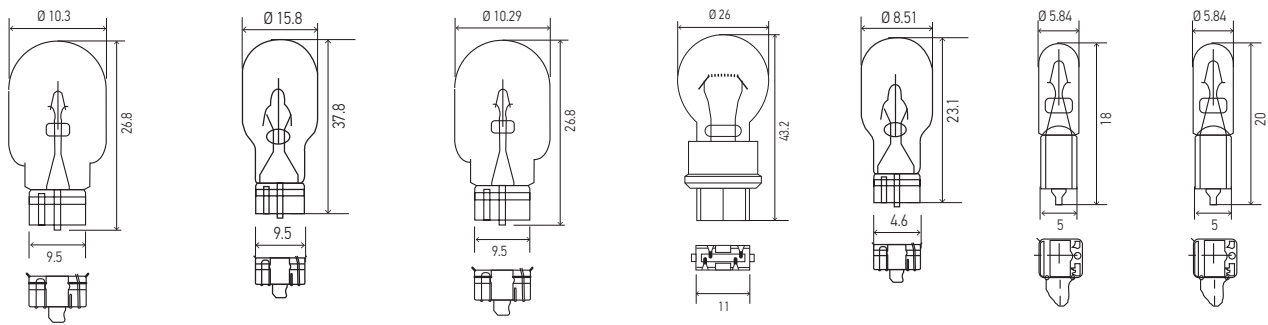

W3x16d	W3x16d	W2.5x16q	B10d	B8.3d	B8.5d	B8.5d
--------	--------	----------	------	-------	-------	-------

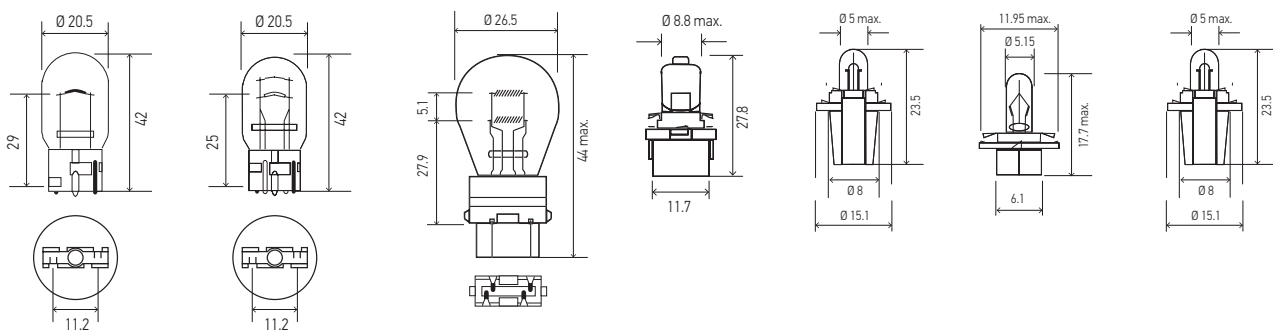

BX8.4d	EBS R4	W2x4.6d	6411 LED	6418 LED	921 LED
--------	--------	---------	----------	----------	---------

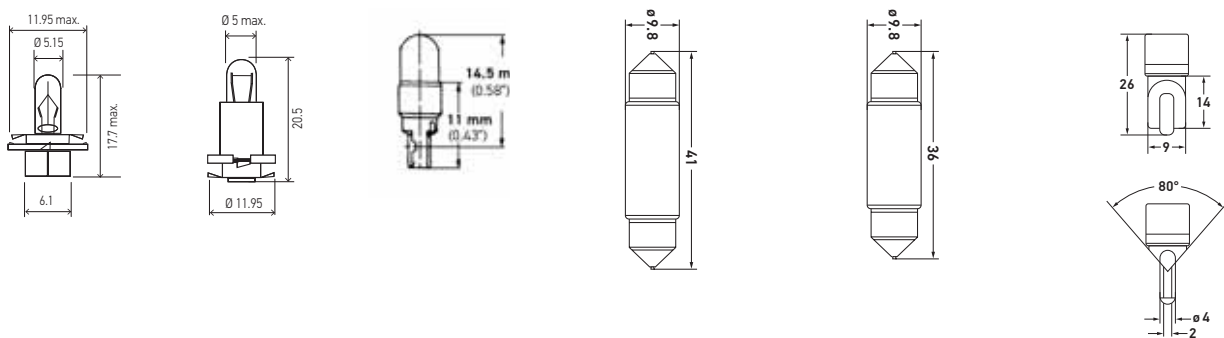

D1S	D2R	D2S	D3S	D4S
-----	-----	-----	-----	-----

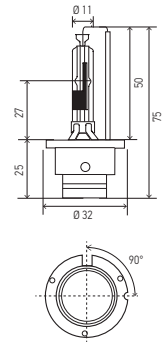
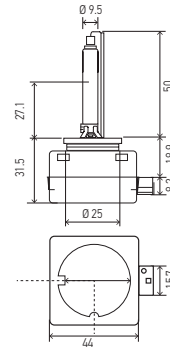
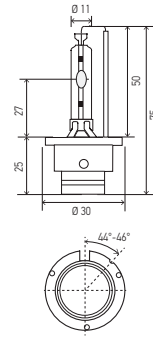
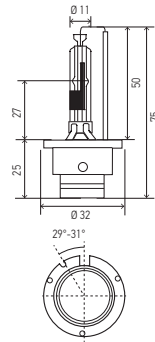
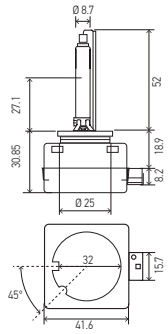



**YOUR EXPERT
FOR VISIBILITY**

HELLA – WIPER BUSINESS. SIMPLIFIED



BEST IN CLASS
MORE THAN 120 YEARS OF
GERMAN INNOVATION



**QUALITY WITHOUT
COMPROMISE**
CONSISTENTLY TESTED



HELLA
RECOGNIZED BRAND



**SATISFIED
CUSTOMERS**
MILLIONS OF BLADES
SOLD EVERY YEAR

SATISFY THE CUSTOMERS NEEDS

DISTRIBUTOR



- Many over distributed brands
- Too much stock / too many PN 's
- More cars with more connections
- Staying profitable is a challenge

MECHANIC



- Quick selection and easy-fit
- Latest coverage
- Easy to sell to end-users
- Competitive pricing

RETAIL



- Find right PN fast → fit fast
- Silent and long lasting
- Cool design
- Pricing

INSIGHTS

NEEDS

- Easy to buy → easy to sell
- Small ranges / maximum coverage
- More profit
- Latest connections & applications

- Easy to handle
- Lasting performance
- Trusted brand
- OE design (upgrade)
- Right price



HELLA WIPER BLADES PROGRAM

NEW AND SIMPLIFIED

MUST HAVE



METAL WIPER

High coverage
Value for money



CLEANTECH 2.0

Flat-Blade Technology
Multi-clips = High coverage



ADDED VALUE



REARS PLASTIC/FLAT

High coverage
Multi-clips





WINTER

Specific technology for harsh winters



HEAVY DUTY

Built tough for professionals



TRUCKS

APPLICATIONS

Find applications chart and installation videos



www.hella.com/wiperblades



METAL WIPER (STANDARD)

FULL COVERAGE – RIGHT PRICE – VALUE FOR MONEY

METAL WIPERS BLISTER PACK

You can always rely on metal wiper blades from HELLA. The blades' rubber lips are coated with graphite so that they can be constantly exposed to the most intense stresses. In addition, the design

minimises annoying wind noise. This means smooth and quiet operation with longer lasting performance, which in return improves safety and driving comfort.

PROPERTIES

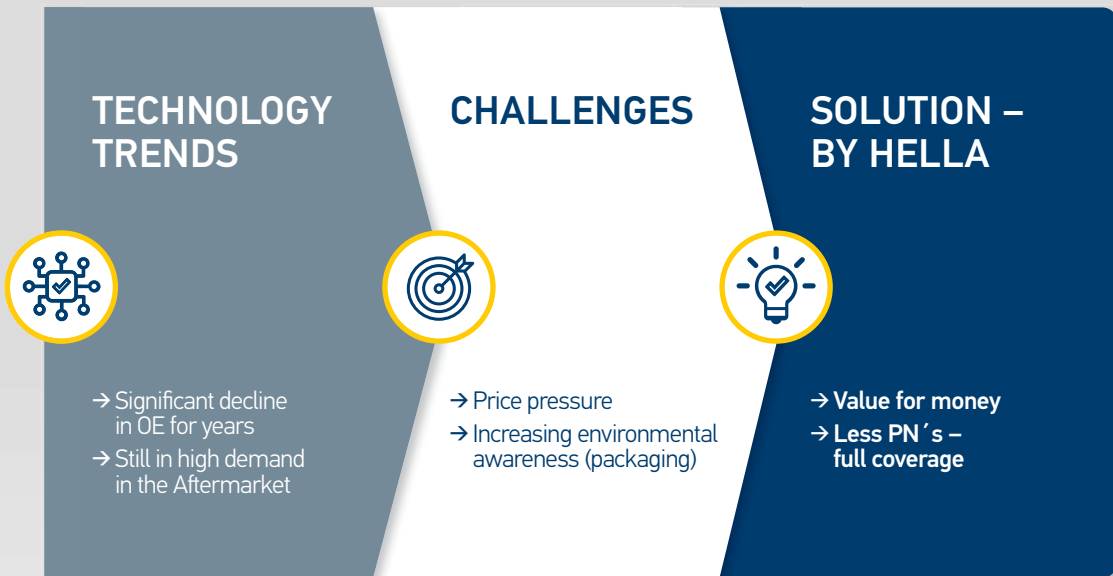

BENEFITS

- EASY CHANGE EASY TO FIT**
- STREAK-FREE RUBBER**
- STREAK-FREE SILENT**
- ALL-WEATHER SAFETY**

ADAPTERS & HOOK-TYPES

ADAPTERS HOOKS

A2-1

ADAPTERS HOOKS

E3

B

V9

SHORT CODES

SHORT CODE	CATALOG P/N	HELLA P/N	LENGTH	ADAPTERS
S11P	9XW398114011	858083111	11"	E3, B, E, V9
S13	9XW398114013	858083131	13"	E3, B, A2-1
S14	9XW398114014	858083141	14"	E3, B, V9
S14P	9XW398114014/14	858083831	14/14"	E3, B, V9
S15	9XW398114015	858083151	15"	E3, B, V9
S16P	9XW398114016	858083801	16"	E3, B, V9
S16	9XW398114016/1	858083161	16"	E3, B, V9
S18P	9XW398114018	858083811	18"	E3, B, V9
S18	9XW398114018/1	858083181	18"	E3, B, V9
S19	9XW398114019	858083191	19"	E3, B, V9
S19/21P	9XW398114019/21	858083821	19/21"	E3, B, V9
S20	9XW398114020	858083201	20"	E3, V9
S20P	9XW398114020/20	858083841	20/20"	E3, V9
S21	9XW398114021	858083211	21"	E3, V9
S22	9XW398114022	858083221	22"	E3, V9
S22P	9XW398114022/22	858083851	22/22"	E3, V9
S24	9XW398114024	858083241	24"	E3, V9
S26	9XW398114026	858083261	26"	E3, V9
S28	9XW398114028	858083281	28"	E3



CLEANTECH

MORE FLEXIBILITY FOR STYLISH AERODYNAMIC FLAT BLADE DESIGN

CLEANTECH 2.0 BLISTER PACK

High tech for the windscreen: the hingeless Clean-Tech 2.0 aerodynamic wiper blades ensure superior wiping results. The aerodynamic spoiler prevents the windscreen wiper from being lifted by the airstream. The nano-coated flat bar wipers glide smoothly over

the glass with even contact pressure. The nano-coating makes the wipers long-lasting. Various adapters ensure a high level of vehicle coverage and easy installation.

PROPERTIES



BENEFITS

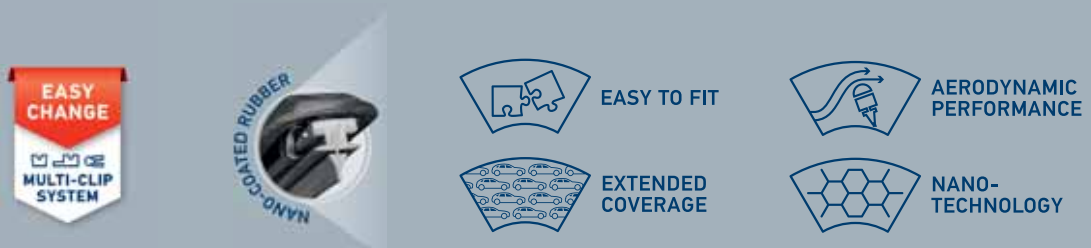

ADAPTERS & HOOK-TYPES

	ADAPTERS	HOOKS		ADAPTERS	HOOKS
3A		 PINCH TAB BAYONET HOOK 9 mm x 4 mm 9 mm x 3 mm		3H-8	 PUSH BUTTON 19 mm PUSH BUTTON 22 mm
3B-2		 SIDE LOCK 19 mm SIDE LOCK 22 mm		3H-9	 PUSH BUTTON 15.5 mm
3C-B		 AUDI & OLD Mercedes Type RENAULT Scenic Type		3T	 PUSH BUTTON FZ
3F		 MULTI HOOK INSERT LOCK		3U	 LIFT & SLIDE

SHORT CODES

SHORT CODE	CATALOG & HELLA P/N	LENGTH	ADAPTERS
CT14	358054141	14"	3A, 3F, 3H-8, 3T
CT15	358054151	15"	3A, 3H-8
CT16	358054161	16"	3A, 3B-2, 3F, 3H-8, 3T
CT17	358054171	17"	3A, 3B-2, 3F, 3H-8, 3H-9
CT18	358054181	18"	3A, 3B-2, 3F, 3H-8, 3T, 3U, 3H-9
CT19	358054191	19"	3A, 3B-2, 3F, 3H-8, 3U, 3H-9
CT20	358054201	20"	3A, 3B-2, 3F, 3H-8, 3T
CT21	358054211	21"	3A, 3B-2, 3F, 3H-8, 3H-9
CT22	358054221	22"	3A, 3B-2, 3C, 3F, 3H-8, 3U, 3T, 3H-9
CT23	358054231	23"	3A, 3B-2, 3F, 3H-8
CT24	358054241	24"	3A, 3B-2, 3C, 3F, 3H-8, 3T, 3U, 3H-9
CT26	358054261	26"	3A, 3B-2, 3F, 3H-8, 3T, 3U
CT28	358054281	28"	3A, 3B-2, 3H-8, 3T, 3U
CT30	358054301	30"	3A, 3B-2, 3F, 3H-8, 3T
CT32	358054321	32"	3B-2, 3F, 3H-8



REAR PLASTIC

MORE FLEXIBILITY FOR REAR-SPECIFIC OE-LIKE DESIGN

REAR PLASTIC BLISTER PACK

For optimum visibility out of the rear window: HELLA Rear-Flat Plastic Wiper Blades are the ideal solution for numerous vehicles and cover up to 20 % of the vehicle fleet.

The special nano-coating not only ensures an optimal, streak-free wiping result, even under adverse conditions, but also guarantees a very long service life. The specially developed, lightweight material

is exceptionally robust and resistant. The modern aerodynamic flat bar design is inspired by original wipers. Thanks to the innovative multi-adapter system, the wipers can be used universally on many vehicles and, thanks to Easy-Fit, can be fitted in just a few simple steps.

PROPERTIES

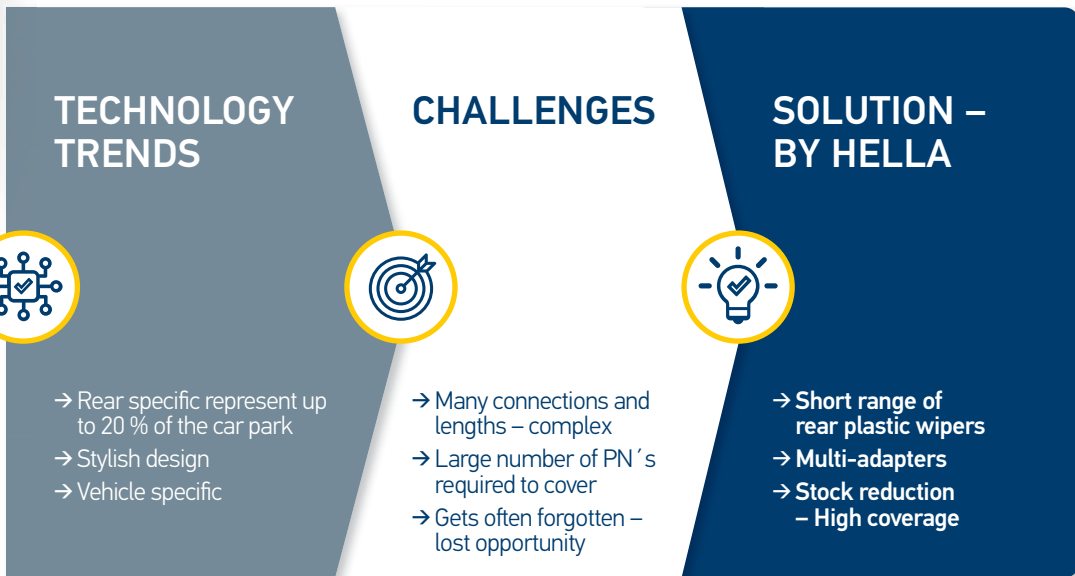

BENEFITS



ADAPTERS & HOOK-TYPES

ADAPTERS

HOOKS

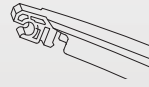
5A

ROCK LOCK 2

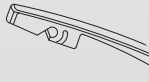
5B

ROCK LOCK 3

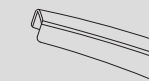
5C

SLIDE PINCH

ADAPTERS

HOOKS

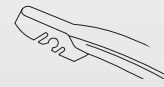
5D

SNAP CLAW L

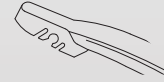
5E

SNAP CLAW H

REAR PLASTIC

SHORT CODE	CATALOG P/N	HELLA PN	LENGTH	ADAPTERS	APPLICATIONS
RP10	9XW358182101	358182101	10"	5A, 5B	Jeep Compass, Toyota Highlander, Honda HR-V
RP11	9XW398114011T	358112911	11"	5A, 5B	Nissan Rogue, Jeep Grand Cherokee, Kia Soul
RP12	9XW398114012T	358112921	12"	5A, 5B, 5E	Toyota RAV4, Honda CR-V, Ford Escape
RP14	9XW398114014T	358112931	14"	5A, 5B, 5C, 5D	Honda CR-V, Jeep Grand Cherokee, Mazda CX-5
RP16	9XW398114016T	358112941	16"	5A, 5B, 5E	Toyota Prius, Honda Odyssey, Dodge Grand Caravan

REAR OE

SHORT CODE	CATALOG P/N	HELLA PN	LENGTH	APPLICATIONS
ROE10	9XW398115010T	358112951	10"	Chevrolet Traverse, Ford Escape, Jeep Liberty, Kia Soul
ROE12	9XW398115012T	358112961	11"	BMW X5, Mazda CX-3, Nissan Kicks
ROE13	9XW398115013T	358112971	12"	Chrysler Pacifica, Ford Crown Victoria, Nissan Pathfinder
ROE14	9XW398115014T	358112981	14"	Chevrolet Blazer, Nissan Versa
ROE15	9XW398115015T	358114151	15"	BMW X5
ROE16	9XW398115016T	358112991	16"	Chevrolet Equinox, Ford Explorer





REAR FLAT

MORE FLEXIBILITY FOR REAR SPECIFIC OE-LIKE FLAT DESIGN

REAR FLAT BLISTER PACK

State-of-the-art technology for the rear window: thanks to their nano-coating, the HELLA Rear Flat Wiper Blades ensure outstanding wiping results in rain, snow and spray water, and all that with extremely low wear. The extremely flat, aerodynamic wiper blades are based on the design of modern

original equipment wipers, so they cut a fine figure at the rear of any vehicle. Thanks to the Easychange system with modular adapters, the wipers can be mounted in just a few simple steps and used on numerous different vehicles.

PROPERTIES

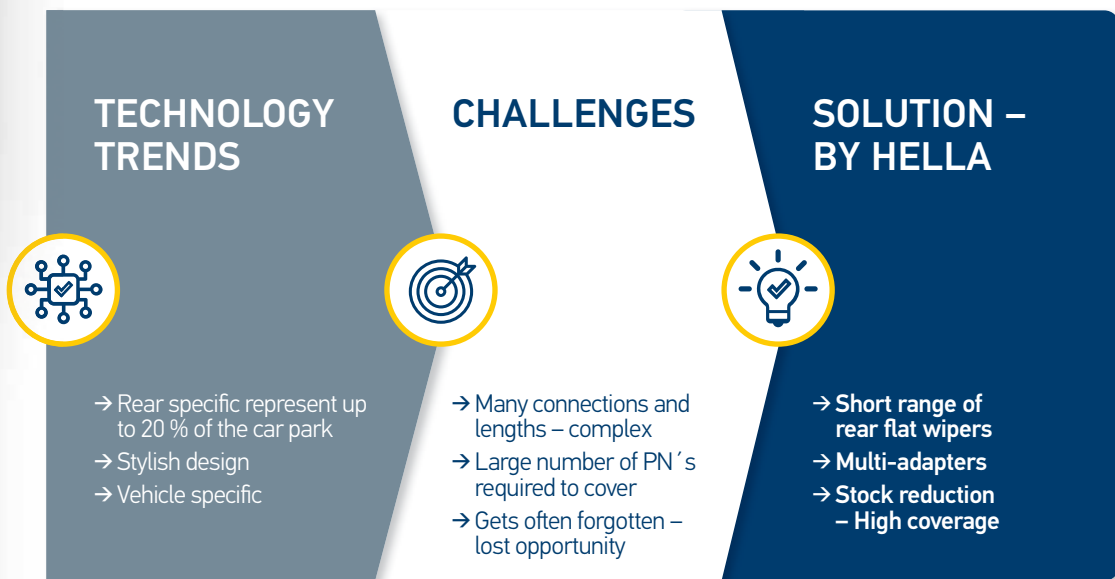

BENEFITS



ADAPTERS & HOOK-TYPES

	ADAPTERS	HOOKS
7A		 U-CLIP
7B		 DOUBLE POST
7C		 PINCH TAB
7D		 SLIDER

	ADAPTERS	HOOKS
7E		 TOP BUTTON
7I		 SLIDER
7J		 CLIP

SHORT CODES

SHORT CODE	CATALOG P/N	HELLA P/N	LENGTH	ADAPTERS	APPLICATIONS
RF10	9XW358179101	358179101	10"	7A, 7C, 7E	Lincoln Corsair, Mini Cooper Countryman
RF11	9XW358179111	358179111	11"	7A, 7C, 7D, 7E	Ford Escape, VW Atlas, BMW X3
RF13	9XW358179131	358179131	13"	7A, 7C, 7D, 7E, 7J	MB GLC300, BMW X3, VW Tiguan
RF14	9XW358179141	358179141	14"	7A, 7B, 7I	Volvo V90, Volvo XC40, Volvo XC60
RF15	9XW358179151	358179151	15"	7A, 7C, 7D, 7J	VW Touareg, Volvo XC60
RF16	9XW358179161	358179161	16"	7A, 7D, 7E, 7J	Ford Expedition, Audi Q7, BMW X7
RF17	9XW358179171	358179171	17"	7A, 7C	Land Rover Range Rover
RF18	9XW358179181	358179181	18"	7A, 7D	-





WINTER

MORE FLEXIBILITY WITH WINTER CONDITIONS PERFORMANCE

WINTER CARTON

The extremely resistant HELLA Winter Wiper Blades are optimised for adverse conditions, such as snow, sleet and road salt, and always ensure a perfect view, even in winter. The wiper lips' special rubber compound is particularly resistant and offers a streak-free wiping experience even in sleet. The robust wiper construction, based on the design of

original wipers, guarantees long durability and perfect function at all times. The easy-to-fit HELLA Winter Wiper Blades are available for various vehicle types.

PROPERTIES

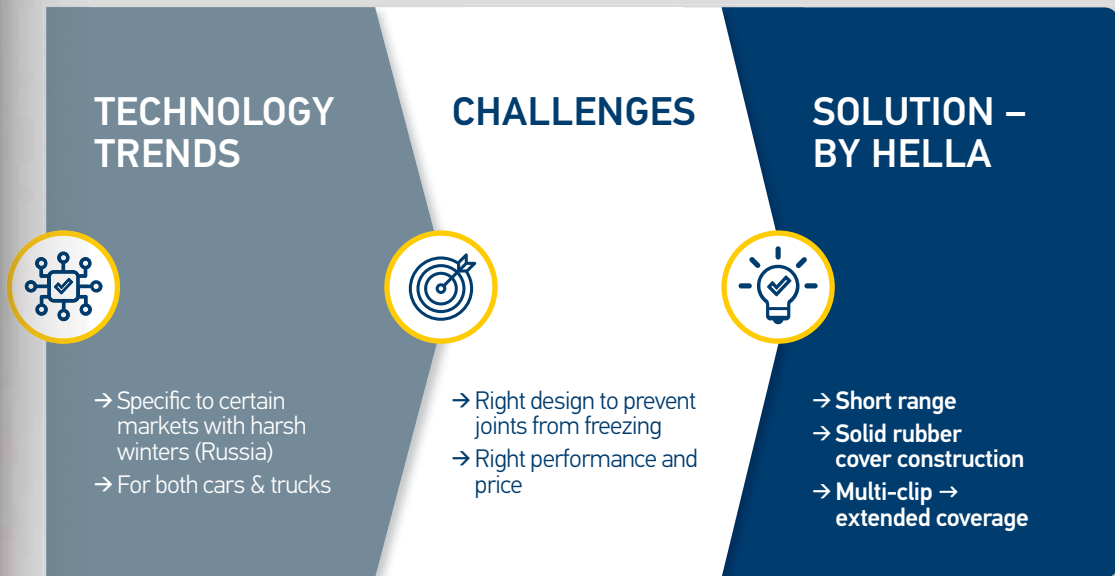

BENEFITS



ADAPTERS & HOOK-TYPES

	ADAPTERS	HOOKS
3A		PINCH TAB BAYONET HOOK 9 mm x 3 mm 9 mm x 4 mm
3B-2		SIDE LOCK 19 mm SIDE LOCK 22 mm
3C-B		AUDI & OLD Mercedes Type RENAULT Scenic Type

	ADAPTERS	HOOKS
3H-8		PUSH BUTTON 19 mm PUSH BUTTON 22 mm
3F		MULTI HOOK INSERT LOCK

SHORT CODES

SHORT CODE	CATALOG P/N	HELLA P/N	LENGTH	ADAPTERS
W35	9XW358004141	358004141	14"	3A, 3B-2, 3H-8, 3C, 3F
W40	9XW358004161	358004161	16"	3A, 3B-2, 3H-8, 3C, 3F
W45	9XW358004181	358004181	18"	3A, 3B-2, 3H-8, 3C, 3F
W48	9XW358004191	358004191	19"	3A, 3B-2, 3H-8, 3C, 3F
W50	9XW358004201	358004201	20"	3A, 3B-2, 3H-8, 3C, 3F
W53	9XW358004211	358004211	21"	3A, 3B-2, 3H-8, 3C, 3F
W55	9XW358004221	358004221	22"	3A, 3B-2, 3H-8, 3C, 3F
W60	9XW358004241	358004241	24"	3A, 3B-2, 3H-8, 3C, 3F
W65	9XW358004261	358004261	26"	3A, 3B-2, 3H-8, 3C, 3F





HEAVY DUTY

MORE FLEXIBILITY FOR LASTING PERFORMANCE

HEAVY DUTY CARTON

HELLA Heavy Duty Wipers defy even the most adverse conditions and heavy loads when used continuously every day on the road or in agriculture, and they reliably ensure a clear view in every situation. Nothing can shake the wipers that easily, thanks to the sturdy, high-quality steel frame. The reinforced

heavy-duty rubber compound ensures long durability and optimum wiping results even in harsher environmental conditions, important attributes for agricultural vehicles in particular. Also available with an integrated spray nozzle for an even better wiping experience.



PROPERTIES



BENEFITS

- EASY CHANGE
BUILT TOUGH
EASY TO FIT
- LASTING PERFORMANCE
- LASTING PERFORMANCE
- LASTING PERFORMANCE
- HIGH QUALITY STEEL FRAME

ADAPTERS & HOOK-TYPES

E3					
		HOOK 9 mm x 3 mm	HOOK 9 mm x 4 mm	BAYONET 7 mm x 2.6 mm	PIN 4.8 mm x 6.3 mm
	ADAPTERS	HOOKS	ADAPTERS	HOOKS	ADAPTERS
F1			M1		
		HOOK 9 mm x 4 mm		SADDLE 13.6, 17 mm	T5
F5			M3		
		HOOK 12 mm x 4 mm		SADDLE 21, 24, 26, 27 mm	T8
F7			M8		
		SADDLE With screws		SADDLE 26 mm	TR4
F10			TR2-1		
		HOOK		SADDLE 7/32", 1/4"	TR9
					
					BAYONET 8.5 mm

SHORT CODES

SHORT CODE	CATALOG P/N	HELLA P/N	LENGTH	ADAPTERS
HD20	9XW191398201	191398201	20"	E3, B, A2-1, TR9+SCREW
HD22	9XW191398221	191398221	22"	E3, B, A2-1, F1, TR4, T5 +SCREW
HD24	9XW191398241	191398241	24"	F5, F10, T8-1+(M9) SCREW, T9
HD26	9XW191398261	191398261	26"	F5, F10, T8-1+(M9) SCREW
HD28	9XW191398281	191398281	28"	F5, F10, T8-1+(M9), G1, F9
HD32	9XW191398321	191398321	32"	M, M1+SCREW, M7+SCREW, M8+SCREW
HD36	9XW191398361	191398361	36"	M2, M3-1 +SCREW, M6+SCREW
HD40SP	9XW191398401	191398401	40"	M2, M3-1 +SCREW, M6+SCREW
HS40SH	9XW191398402	191398402	40"	F7 (HOOK)

SPECIFIC (NEW)

HDT15	9XW358178151	358178151	15"	TR2-1
HDT16	9XW358178161	358178161	16"	TR2-1
HDT18	9XW358178181	358178181	18"	TR2-1
HDT20	358178201	358178201	20"	TR2-1
HDT22	358178221	358178221	22"	TR2-1

ELECTRICAL WATER PUMPS, 12V

Part Number	Function	Voltage (V)	Design	Delivery flow g / min(l/min)	Pressure (bar)	Cap Part Number	Housing diameter inches (mm)	Inlet diameter inches(mm)	Outlet diameter inches(mm)
004223031	Headlight / windshield	12	Single	0.264 (1)	2	008151021	1.378 (35)	0.276 (7)	0.236 (6)
005496011	Headlight / windshield	12	Single	0.264 (1)	2		1.378 (35)	0.276 (7)	0.236 (6)
005206031	Windshield cleaning	12	Double	0.264 (1)	2	008151021	1.378 (35)	0.276 (7)	0.236 (6)
007540211	Windshield cleaning	12	Single	1.902 (7.2)	2.5	008151021	1.378 (35)	0.453 (11.5)	0.433 (11)
004764021	Headlight cleaning	12	Single	1.902 (7.2)	2.5	008151021	1.378/1.811 (35/46)	0.413 (10.5)	0.433 (11)



ELECTRICAL WATER PUMPS, 24V

Part Number	Function	Voltage (V)	Design	Delivery flow g / min(l/min)	Pressure (bar)	Cap Part Number	Housing diameter inches (mm)	Inlet diameter inches (mm)	Outlet diameter inches(mm)
004764041	Headlight / windshield	24	Single	1.902 (7.2)	2.5	008151021	1.378/1.811 (35/46)	0.413 (10.5)	0.433 (11)
005496051	Windshield cleaning	24	Single	0.264 (1)	2	008151021	1.378 (35)	0.276 (7)	0.236 (6)
007540231	Windshield cleaning	24	Single	1.902 (7.2)	2.5	008151021	1.378 (35)	0.413 (10.5)	0.433 (11)



HEADLIGHT CLEANING SYSTEMS

Part Number	Function	Voltage (V)	Spare part: Pump
008549001	Headlight cleaning system with fixed nozzles	12V	007540211
008549501	Headlight cleaning system with fixed nozzles	24V	007540231

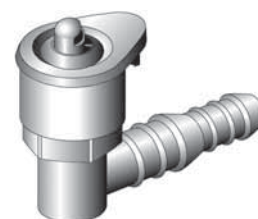

RELAY

Part Number	Function	Voltage (V)	Number of polos	Temperature range °F (°C)	Notes
003620091	Cleaning / Washing Interval	12V	6	-22/185° (-30/+85°)	Without holder

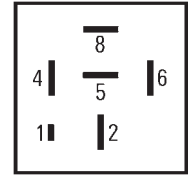

TANK

Part Number	Function	Color	Tank capacity Gal (L)	Voltage	Design	Spare part: Pump	Packing unit
003248001	Washer fluid tank, window	White	0.396 (1.5)	12V	Single	004223031	1 piece
003966047	Washer fluid tank, window	White	2.113 (8)	12V	Single or Double	004223031	24 pieces
003443011	Washer fluid tank, window	White	0.793 (3)	24V	Single	005496051	1 piece
007757047	Washer fluid tank, window	Black	5.283 (20)	24V	Single	005496051	20 pieces

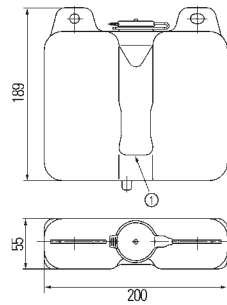
003248001

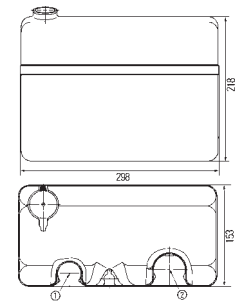

003966047



003443011

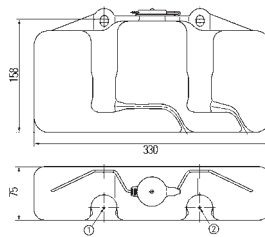

007757047

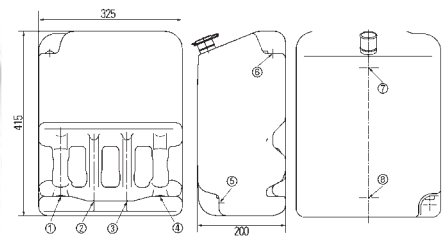

YOUR SAFETY IS OUR PRIORITY



MICROSITE: Find out about
HELLA Electrics range



www.hellahd.com

Quality is extremely important in electric HELLA products such as relays, speakers, switches, flashing lights, electric vacuum pumps, plugs, sockets and much more, due to their high precision and reliability. HELLA products not only comply with the strict legal regulatory requirements but also with the much more demanding requirements made by vehicle manufacturers and the aftermarket.



RELAYERS, FLASHERS, FUSES AND CONTROL DEVICES

Our relays, flashers and controllers are designed to do their job reliably for a long time. And because perfection and durability is one of our strengths to the smallest detail, HELLA offers the most reliable products and one of the widest ranges in this sector: mini-relays, high performance relays, micro relays, relays battery disconnection and solid state relays, for cars, commercial vehicles and trucks; flashers with the classification of a single circuit, flashers of two and three circuits for trucks, vans, commercial vehicles, agricultural and construction machines, time control units and LED light, as well as light switch modules..



ACOUSTIC SIGNAL UNITS

A security product that does not require many words: horns, bugles and trumpets. Whether you choose the harmonic sound of the two-tone electric disc horn or the penetrating sound of our supertone bugles, your customers will surely be able to be noticed.

The trumpets of pressurized air; Our warning signs are always at the forefront. We have been integrating reliability and precision for over 100 years. At HELLA, security simply has tradition.

HORNS APP - Online tool to compare the different acoustic signal units



www.hella.com/apps



Series	 Part Number	 Frequency	 Acoustic Intensity	 Voltage	 Energy consumption	 Diameter / Size	 Packaging / Content					
S70M 	012588011	380 / 480 Hz	108 dB (A)	12 V	2 x 16 W	7 cm 7 x 9.5 cm	Box - 2 pieces	■				
	012588061	460 Hz	108 dB (A)	12 V	1 x 16 W		Box - 1 piece	■				
S77 	011225802	350 / 420 Hz	111 dB (A)	12 V	2 x 42 W	7.7 cm 4.7 x 10.5 cm	Box - 2 pieces	■	■	■		
	011225881	350 / 420 Hz	111 dB (A)	12 V	2 x 42 W		Box - 2 pieces			Toyota		
	011225891	350 / 420 Hz	111 dB (A)	12 V	2 x 42 W		Box - 2 pieces			Honda		
	012588351	430 Hz	111 dB (A)	12 V	1 x 42 W		Blister - 1 piece	■	■	■		
S92 	011225871	335 / 435 Hz	113 db (A)	12 V	2 x 60 W	9.2 cm 9.2 x 5.6 cm	Box - 2 pieces	■	■	■		
	012588071	435 Hz	113 db (A)	12 V	1 x 60 W		Blister - 1 piece	■	■	■		
	002768821	335 / 435 Hz	113 db (A)	24 V	2 x 72 W		Box - 2 pieces	■	■	■		
	012588141	335 Hz	113 db (A)	12 V	1 x 60 W		Blister - 1 piece	■	■	■		
S98 	012588341	335 / 400 HZ	115 dB (A)	12 V	2 x 54 W	9.8 cm 8.8 x 5.4 cm	Box - 2 pieces	■	■	■		
	012588291	400HZ	115 dB (A)	12 V	1 x 54 W		Box - 1 piece					
M26 	002952811	400 Hz	115 db (A)	12 V	1 x 66 W	9.7 cm 5.4 x 12.2 cm	Box - 1 piece		■	■		
	002952861	335 Hz	115 db (A)	12 V	1 x 66 W		Box - 1 Piece		■	■		
	006958901	335 Hz	115 db (A)	12 V	1 x 66 W		Box - 1 piece (Black)		■	■		
B36 	002768082	335 Hz	116 db (A)	12 V	1 x 72 W	11.2 cm 5.3 x 12.9 cm	Box - 1 piece		■	■		
	002768551	400 Hz	116 db (A)	12 V	1 x 72 W		Box - 1 piece		■	■		
	002768382	335 Hz	116 db (A)	24 V	1 x 72 W		Box - 1 piece		■	■		
	002768431	400 Hz	116 db (A)	24 V	1 x 72 W		Box - 1 piece		■	■		
S130 	004811091	280 / 380 Hz	118 dB (A)	12 V	2 x 48 W	13 cm 13 x 8.1 cm	Box - 2 pieces		■	■	■	■
	004811071	280 / 380 Hz	118 dB (A)	24 V	2 x 48 W		Box - 2 pieces		■	■	■	■
S140 	004811101	280 / 380 Hz	118 dB (A)	12 V	2 x 48 W	14 cm 14 x 8.2 cm	Box - 2 pieces		■	■	■	■
	004811081	280 / 380 Hz	118 dB (A)	24 V	2 x 48 w		Box - 2 pieces		■	■	■	■
M26S 	922000731	350 / 415 Hz	115 db (A)	12 V	2 x 42 W	10.8 cm 6.65 x 12.2 cm	Box - 2 pieces		■	■	■	■
B133 	003399801	300 / 500 Hz	118 db (A)	12 V	2 x 66 W	12.3 cm 8.5 x 12.5 cm	Box - 2 pieces + Relay		■	■	■	■
	003399901	300 / 500 Hz	118 db (A)	12 V	2 x 66 W		Blister - 2 pieces + Relay		■	■	■	■
	358114051	500 Hz	118 db (A)	12 V	1 x 66 W		Box - 1 piece		■	■	■	■
B133 	003399101	375 / 500 Hz	118 db (A)	24 V	2 x 84 W	12.3 cm 8.5 x 12.5 cm	Box - 2 pieces		■	■	■	■
	003399061	375 Hz	118 dB (A)	24 V	1 x 84 W		Box - 1 piece		■	■	■	■
	003399071	500 Hz	118 dB (A)	24 V	1 x 84 W		Box - 1 piece		■	■	■	■
DL50 	004811001	310 Hz	114 dB (A)	12 V	1 x 72 W	13 cm 6.1 x 14.3 cm	Box - 1 piece			■	■	■
	004811011	380 Hz	114 dB (A)	12 V	1 x 72 W		Box - 1 piece			■	■	■
	004811021	310 Hz	114 dB (A)	24 V	1 x 84 W		Box - 1 piece			■	■	■
	004811031	380 Hz	114 dB (A)	24 V	1 x 84 W		Box - 1 piece			■	■	■
TC16 	011225831	400 / 500 Hz	113 dB (A)	12 V	2 x 72 W	8.6 cm 8.6 x 10.9 cm	Box - 2 pieces	■	■	■		
	012010971	400 / 500 Hz	113 dB (A)	12 V	2 x 72 W		Blister- 2 pieces	■	■	■		

Specific Application

Series	Part Number	Frequency	Acoustic Intensity	Voltage	Energy consumption	Diameter / Size	Packaging / Content						
TE16 	012010981	400 / 500 Hz	110 db (A)	12 V	2 x 72W	8.1 cm 8.1 x 10.9 cm	Box - 2 pieces + Relay	■	■	■			
	007424801	400 / 500 Hz	110 db (A)	12 V	2 x 72W		Box - 2 pieces + Relay	■	■	■			
	012010851	400 / 500 Hz	110 db (A)	12 V	2 x 72 W		Box - 2 pieces	■	■	■			
	007424811	400 / 500 Hz	110 db (A)	12 V	2 x 72 W		Box - 2 pieces	■	■	■			
	012010801	400 / 500 Hz	110 db (A)	12 V	2 x 72 W		Box - 2 pieces	■	■	■			
	012010821	400 / 500 Hz	110 db (A)	12 V	2 x 72 W		Box - 2 pieces	■	■	■			
	007424001	400 Hz	110 db (A)	12 V	1 x 72 W		Box - 1 Pieces..	■	■	■			
	007424011	400 Hz	110 db (A)	12 V	1 x 72 W		Box - 1 Pieces.	■	■	■			
TC16S 	011225841	400 / 500 Hz	113 db (A)	12 V	2 x 72 W	8.6 cm 8.6 x 10.9 cm	Box - 2 pieces		Audi, Seat VW				
	012010881	400 / 500 Hz	113 db (A)	12 V	2 x 72 W		Box - 2 pieces		BMW				
	011225921	400 / 500 Hz	113 db (A)	12 V	2 x 72 W		Box - 2 pieces		Ford				
	012010911	400 / 500 Hz	113 db (A)	12 V	2 x 72 W		Box - 2 pieces		Honda				
	011225901	400 / 500 Hz	113 db (A)	12 V	2 x 72 W		Box - 2 pieces		Hyundai				
	012010891	400 / 500 Hz	113 db (A)	12 V	2 x 72 W		Box - 2 pieces		Peugeot				
	012010901	400 / 500 Hz	113 db (A)	12 V	2 x 72 W		Box - 2 pieces		Toyota				
	011225851	400 / 500 Hz	113 db (A)	12 V	2 x 72 W		Box - 2 pieces		VW				
TE20C 	007728883	410 / 510 Hz	112 db (A)	12 V	2 x 60 W	8.6 cm 9.1 x 9.7 cm	Box - 2 pieces	■	■	■	■	■	
TE20 	940800821	410 / 510 Hz	110 db (A)	24 V	2 x 72 W	8.6 cm 9.1 x 9.7 x 8.7	Box - 1 Piece				■	■	
Tornado Compressed Air Trumpet Horn 	013410081	520 / 660 Hz	112 db (A)	12 V	1 x 240 W	13.6x9x11.5	Box - 1 piece			■	■	■	
	013410091	520 / 660 Hz	112 db (A)	24 V	1 x 240 W		Box - 1 piece			■	■	■	
Highway Trumpet 	005411001	300 - 350 Hz	118 dB (A)	24 V	0 - 20 W	8 cm 7.8 x 16 x 41.5	Box - 1 piece				■	■	
Air Compressor Trumpet 	004206041	400 Hz	118 dB (A)	12 V	35 W	11.9 cm 9.7 x 9 x 31.1	Box - 1 piece				■	■	
	004206011	400 Hz	118 dB (A)	24 V	50 W		Box - 1 piece					■	■
Double Tone Air Trumpet 	003001651	780 / 840 Hz	118 dB (A)	12 V	240 W	16.3 cm 21.2 cm (longitudes)	Blister - 1 Set.			■	■	■	
	003001661	780 / 840 Hz	118 dB (A)	24 V	240 W		Blister - 1 Set.			■	■	■	
Triple Tone Air Trumpet 	003001671	780/820/880	118 dB (A)	12 V	240 W	15.8 cm 16.6 cm 21.7 cm (longitudes)	Blister - 1 Set.			■	■	■	
	003001981	630/795/840	118 dB (A)	12 V	240 W		Blister - 1 Set.			■	■	■	
Air Compressor Horn 	013410001	-	115 dB (A)	12 V	312 W	9.2x8.4x38.6	Blister - 1 Set.				■	■	
Chrome Double Air Horn 	013410051	-	125 dB (A)	12 V	41 W	40.2x9.6 x 15.6	Box - 1 piece				■	■	
	013410061	-	125 dB (A)	24 V	77 W		Box - 1 piece					■	■
Single-tone air horn 	013410011	-	115 dB (A)	12 V 24 V	120 W	11.6x14.4x20.3	Box - 1 piece				■	■	
Backup Alarm 	009148142	1200 Hz	110 dB (A)	9 - 28 V	5.5 W	10.1x3.9x6.5	Blister - 1 piece		■	■	■	■	
	009148141	1200 Hz	110 dB (A)	9 - 28 V	5.5 W		Box - 1 piece		■	■	■	■	
	009148161	1200 Hz	110 dB (A)	9 - 28 V	5.5 W		Box - 1 piece		■	■	■	■	
	009148221	1200 Hz	107 dB (A)	9 - 28 V	5.5 W		Box - 1 piece		■	■	■	■	
Backup Alarm 	996139001	1200 Hz	87 dB (A)	12 - 36 V	0.59 A	18x7.8x10.2	Box - 1 piece		■	■	■	■	
	996139101	1300 Hz	107 dB (A)	12 - 36 V	0.4 A		Box - 1 piece		■	■	■	■	
	996139111	1250 Hz	112 dB (A)	12 - 36 V	0.4 A		Box - 1 piece		■	■	■	■	
Backup Alarm 	009148001	1250 Hz	90 dB (A)	12 - 24 V	0.2 A	10.1 x 6 x 7.4	Box - 1 piece		■	■	■	■	
	009148011	1250 Hz	97 dB (A)	12 - 24 V	0.4 A		Box - 1 piece		■	■	■	■	
	009148021	1250 Hz	107 dB (A)	12 - 24 V	0.7 A		Box - 1 piece		■	■	■	■	

Specific Application

Product image / Dimensions	Features
----------------------------	----------

S70M Series - Horns for Motorcycles



Housing and bracket in black galvanized metal.
 Level of acoustic intensity at 2 m distance: 108 dB (A).
 Energy consumption: 16 W.
 M8 screw horn bracket.
 Operating Temperature: -40° C a 90° C (-40°F a 194°F)
 Approval: ECE

380 / 480 Hz 108 dB (A) 12 V~
 7 cm (2.75") 2 x 16 W



2 Pieces

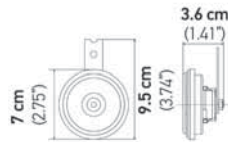

Part Number	Quantity	Description
012588011	2 Pieces	Horns Box (graphic) 12 V, 2 x 16 W, 380 / 480 Hz - Universal Diameter Measurements: 7 cm 7 x 9.5 cm
012588061	1 Piece	High Tone - Box (graphic) Horn 12 V, 16 W, 460 Hz - Universal Diameter Measurements: 7 cm 7 x 9.5 cm

S77 Series - Compact Horns



Housing and bracket in black galvanized metal.
 Level of acoustic intensity at 2 m distance: 111 dB (A).
 Energy consumption: 2 x 42 W
 M8 screw horn bracket.
 Operating Temperature: -40° C a 90° C (-40°F a 194°F)
 With flat connections of 6.3 mm, open, blade type
 With Teflon gasket as protection against moisture.
 Approval: ECE R28

350 / 420 Hz 111 dB (A) 12 V~
 7.7 cm (3.03") 2 x 42 W ECE R28

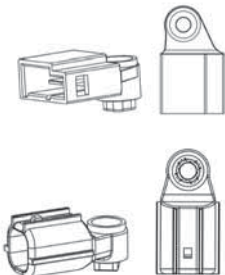

2 Pieces

1 Piece

1 Piece

Part Number	Quantity	Description
011225802	2 Pieces	Box (graphic) Horns 12 V, 2 x 42 W, 350/420 Hz - Universal Diameter Measurements: 7.7 cm 4.7 x 10.5 cm
012588351	1 Piece	High Tone - Plastic blister Horn 12 V, 1 x 42 W, 430 Hz - Universal Diameter Measurements: 7.7 cm 4.7 x 10.5 cm Individual presentation in blister pack
011225881	2 Pieces	Horns 12 V, 2 x 42 W, 350/420 Hz - TOYOTA Diameter Measurements: 7.7 cm 4.7 x 10.5 cm With specific connector for Toyota
011225891	2 Pieces	Horns 12 V, 2 x 42 W, 350/420 Hz - HONDA Diameter Measurements: 7.7 cm 4.7 x 10.5 cm With specific connector for Honda

Product image / Dimensions	Features
----------------------------	----------



2 Piece

1 Piece

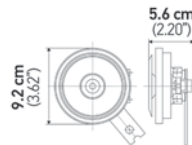

S92 Series



Housing, diaphragm and bracket in black galvanized metal.
 Level of acoustic intensity at 2 m distance: 113 dB (A).
 Energy consumption: 2 x 60 W @ 12 V | 2 x 72 W @ 24 V
 M8 screw horn bracket.
 Operating Temperature: -40° C a 90° C (-40°F a 194°F).
 With flat connections of 6.3 mm, open, blade type.
 Approval: CCC



Part Number	Quantity	Description
011225871	2 Pieces	Box (graphic) Horns 12 V, 2 x 60 W, 335/435 Hz - Universal Diameter Measurements: 9.2 cm 9.2 x 5.6 cm
002768821	2 Pieces	Box (graphic) Horns 24 V, 2 x 72 W, 335/435 Hz - Universal Diameter Measurements: 9.2 cm 9.2 x 5.6 cm
012588071	1 Piece	High Tone - Plastic blister Horn 12 V, 1 x 60 W, 435 Hz - Universal Diameter Measurements: 9.2 cm 9.2 x 5.6 cm
012588141	1 Piece	Low Tone - Plastic blister Horn 12 V, 1 x 60 W, 335 Hz - Universal Diameter Measurements: 9.2 cm 9.2 x 5.6 cm

NEW

S98 Series



2 Pieces

1 Piece

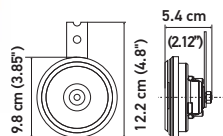

Black housing with red with red diaphragm and galvanized metal bracket.
 Level of acoustic intensity at 2 m distance: 115 dB(A).
 Energy consumption: 54 W
 M8 screw horn bracket.
 Operating Temperature: -40° C a 90° C (-40°F a 194°F)
 With flat connections of 6.3 mm, open, blade type
 Approval: ECE R2



Part Number	Quantity	Description
012588341	2 Pieces	Box (graphic) Horn 12 V, 2 x 54 W, 335 / 400 Hz - Universal Diameter Measurements: 9.8 cm 9.8 x 12.2 cm
012588291	1 Piece	Box (graphic) Low Tone 12 V, 54 W, 400 Hz - Universal Diameter Measurements: 9.8 cm 9.8 x 12.2 cm

Product image / Dimensions	Features
----------------------------	----------



B36 Series

Housing and bracket in galvanized metal, black diaphragm
 Level of acoustic intensity at 2 m distance: 116 dB (A).
 Energy consumption: 72 W.
 M8 screw horn bracket.
 Operating Temperature: -40° C a 90° C (-40°F a 194°F)
 Approval: ECE R28

335 / 400 Hz 116 dB (A) 12 V-24 V
 11.2 cm (4.40") 72 W ECE R28

Part Number	Quantity	Description
002768082	1 Piece	Low Tone
		Horn 12 V, 72 W, 335 Hz - Universal Diameter Measurements: 11.2 cm 5.3 x 12.9 cm
002768551	1 Piece	High Tone
		Horn 12 V, 72 W, 400 Hz - Universal Diameter Measurements: 11.2 cm 5.3 x 12.9 cm
002768382	1 Piece	Low Tone - 24 V
		Horn 24 V, 72 W, 335 Hz - Universal Diameter Measurements: 11.2 cm 5.3 x 12.9 cm
002768431	1 Piece	High Tone - 24 V
		Horn 24 V, 72 W, 400 Hz - Universal Diameter Measurements: 11.2 cm 5.3 x 12.9 cm



1 Piece

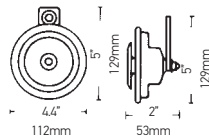

S130 Series

Distinctive look and heavy-duty design
 Level of acoustic intensity at 2 m distance: 118 dB(A).
 Embedded HELLA Logo on the center of the grille
 Black coated housing with a chromed protective grille
 Enhanced low bass sound
 Available for 12 V and 24 V
 Operating Temperature: -40° C a 90° C (-40°F a 194°F)

280/ 380 Hz 118 dB (A) 12 V-24 V
 13 cm (5.11") 2 x 48 W ECE-R28

Part Number	Quantity	Description
004811091	2 Pieces	Box (graphic) Horn 12 V, 2 x 48 W, 280/380 Hz - Universal Diameter Measurements: 13 cm 13 x 8.1 cm
004811071	2 Pieces	Box (graphic) Horn 24 V, 2 x 48 W, 280/380 Hz - Universal Diameter Measurements: 13 cm 13 x 8.1 cm



2 Pieces

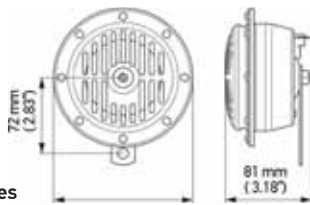

S140 - Set of Horns

Housing and bracket in galvanized metal, black diaphragm
 Level of acoustic intensity at 2 m distance: 118 dB (A).
 Energy consumption: 2 x 48 W.
 M8 screw horn bracket.
 Operating Temperature: -40° C a 90° C (-40°F a 194°F)
 Approval: ECE R28

350 / 415 Hz 115 dB (A) 12 V-24 V
 10.8 cm (4.25") 2 x 42 W ECE R28

Part Number	Quantity	Description
004811101	2 Pieces	Horns 12 V, 2 x 48 W, 280 / 380 Hz - Universal Diameter Measurements: 14.4 cm 14.4 x 82.4 cm
004811081	2 Pieces	Horns 12 V, 2 x 48 W, 280 / 380 Hz - Universal Diameter Measurements: 14.4 cm 14.4 x 82.4 cm

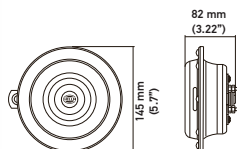

Product image / Dimensions	Features
----------------------------	----------

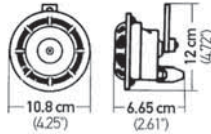

M26S Series - Set of Horns



Black housing and bracket, yellow protective grid and blue diaphragm in galvanized metal.
 Level of acoustic intensity at 2 m distance: 115 dB(A).
 Energy consumption: 2 x 42 W.
 M8 screw horn bracket.
 Operating Temperature: -40° C a 90° C (-40°F a 194°F)
 With flat connections of 6.3 mm, open, blade type
 Approval: ECE R28



Part Number	Quantity	Description
922000731	2 Pieces	Horns 12 V, 2 x 42 W, 350 / 415 Hz - Universal Diameter Measurements: 10.8 cm 6.65 x 12.2 cm



2 Pieces
1 Relay

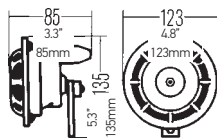

2 Pieces
1 Relay

1 Piece

B133 Series - Supertone Horns with 12 V Relay



Extremely concentrated sound radiation and powerful range. Particularly suitable for traffic on motorways.

Black housing, diaphragm and bracket, red protective grille, in galvanized metal.
 Level of acoustic intensity at 2 m distance: 118 dB(A).
 Energy consumption: 2 x 66 W
 M8 screw horn bracket.
 Operating Temperature: -40° C a 90° C (-40°F a 194°F)
 With flat connections of 6.3 mm, open, blade type
 Approval: ECE R28



Part Number	Quantity	Description
003399901	2 Pieces	Plastic blister Horns 12 V, 2 x 66 W, 300/500 Hz - Universal Diameter Measurements: 12.3 cm 8.5 x 12.5 cm
	1 Piece	Includes 12 V Relay
003399801	2 Pieces	Box (graphic) Horns 12 V, 2 x 66 W, 300/500 Hz - Universal Diameter Measurements: 12.3 cm 8.5 x 12.5 cm
	1 Piece	Includes 12 V Relay
358114051	1 Piece	High Tone - Box (yellow) Horn 12 V, 1 x 66 W, 500 Hz - Universal Diameter Measurements: 12.3 cm 8.5 x 12.5 cm



2 Pieces

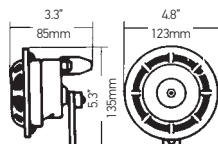

B133 Series - Set of Supertone Horns



Black housing, protective grille and bracket, in galvanized metal.
 Level of acoustic intensity at 2 m distance: 118 dB(A).
 Energy consumption: 2 x 84 W @ 24 V
 M8 screw horn bracket.
 Operating Temperature: -40° C a 90° C (-40°F a 194°F)
 With flat connections of 6.3 mm, open, blade type
 Approval: ECE R28



Part Number	Quantity	Description
003399101	2 Pieces	Horns 24 V, 2 x 84 W, 375/500 Hz - Universal Diameter Measurements: 12.3 mm 8.5 x 12.5 cm
003399061	1 Piece	Low Tone Horns 24 V, 1 x 84 W, 375 Hz - Universal Diameter Measurements: 12.3 cm 8.5 x 12.5 cm
003399071	1 Piece	High Tone Horns 24 V, 1 x 84 W, 500 Hz - Universal Diameter Measurements: 12.3 cm 8.5 x 12.5 cm

Product image / Dimensions

Features



002952811 / 002952861



006958901

M26 Series



Housing and bracket in galvanized metal, black diaphragm
 Level of acoustic intensity at 2 m distance: 115 dB (A).
 Energy consumption: 66 W.
 M8 screw horn bracket.
 Operating Temperature: -40° C a 90° C (-40°F a 194°F)
 With flat connections of 6.3 mm, open, blade type
 Approval: ECE R28

335 / 400 Hz 115 dB (A) 12 V

9.7 cm (3.81") 66 W ECE R28

Part Number	Quantity	Description
002952811	1 Piece	High tone Horn 12 V, 66 W, 400 Hz - Universal, silver Diameter Measurements: 9.7 mm 5.4 x 12.2 cm
002952861	1 Piece	Low Tone Horn 12 V, 66 W, 335 Hz - Universal, silver Diameter Measurements: 9.7 mm 5.4 x 12.2 cm
006958901	1 Piece	Low Tone Horn 12 V, 66 W, 335 Hz - Universal, black Diameter Measurements: 9.7 mm 5.4 x 12.2 cm

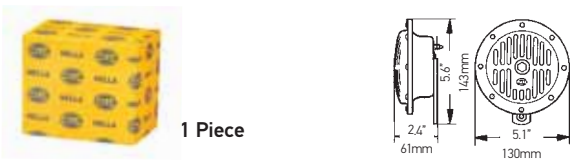

1 Piece

DL50 Series



Black housing and bracket in galvanized metal.
 Level of acoustic intensity at 2 m distance: 114 dB(A).
 Energy consumption: 72 W
 M8 screw horn bracket.
 Operating Temperature: -40° C a 90° C (-40°F a 194°F)
 With flat connections of 6.3 mm, open, blade type
 Approval: ECE R28

310 / 380 Hz 114 dB (A) 12 V

13 cm (5.11") 72 W ECE R28

Part Number	Quantity	Description
004811001	1 Piece	Low Tone Horn 12 V, 72 W, 310 Hz - Universal Diameter Measurements: 13 cm 6.1 x 14.3 cm
004811011	1 Piece	High Tone Horn 12 V, 72 W, 380 Hz - Universal Diameter Measurements: 13 cm 6.1 x 14.3 cm
004811021	1 Piece	Low Tone Horn 24 V, 84 W, 310 Hz - Universal Diameter Measurements: 13 cm 6.1 x 14.3 cm
004811031	1 Piece	High Tone Horn 24 V, 84 W, 380 Hz - Universal Diameter Measurements: 13 cm 6.1 x 14.3 cm

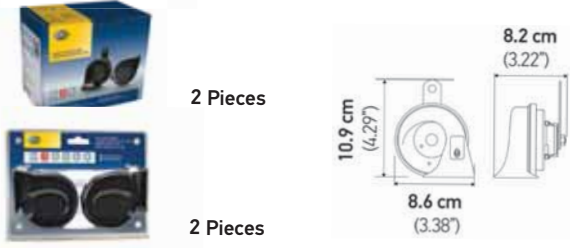

2 Pieces

2 Pieces

TC16 Series



ABS plastic housing and galvanized metal bracket
 Level of acoustic intensity at 2 m distance: 113 dB(A).
 Energy consumption: 2 x 72 W.
 M8 screw horn bracket.
 Operating Temperature: -40° C a 90° C (-40°F a 194°F)
 With flat connections of 6.3 mm, open, blade type
 Approval: CCC

400 / 500 Hz 113 dB (A) 12 V

8.6 cm (3.38") 2 x 72 W CCC

Part Number	Quantity	Description
011225831	2 Pieces	Box (graphic) Trumpets 12 V, 2 x 72 W, 400 / 500 Hz - Universal Diameter Measurements: 8.6 cm 8.6 x 10.9 cm
012010971	2 Pieces	Plastic blister Horn 12 V, 2 x 72 W, 400 / 500 Hz - Universal Diameter Measurements: 8.6 cm 8.6 x 10.9 cm

Product image / Dimensions	Features
----------------------------	----------



TE16 Series - Set of Twin Tone Trumpet Horns with 12 V Relay

ABS plastic housing and black bracket in galvanized metal.
 Level of acoustic intensity at 2 m distance: 110 dB(A).
 Energy consumption: 2 x 72 W.
 M8 screw horn bracket.
 Operating Temperature: -40° C a 90° C (-40°F a 194°F)
 With flat connections of 6.3 mm, open, blade type
 Approval: ECE R28
 Includes 12 V Relay



2 Pieces
1 Relay

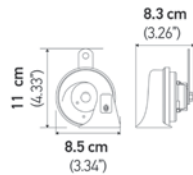

Part Number	Quantity	Description
007424801	2 Pieces	Trumpets 12 V, 2 x 72 W, 400 / 500 Hz - Universal Diameter Measurements: 8.1 cm 8 x 10.9 cm Red Horn
	1 Piece	Includes 12 V Relay



TE16 Series - Set of Trumpets

ABS plastic housing and black bracket in galvanized metal.
 Level of acoustic intensity at 2 m distance: 110 dB(A).
 Energy consumption: 2 x 72 W.
 M8 screw horn bracket.
 Operating Temperature: -40° C a 90° C (-40°F a 194°F)
 With flat connections of 6.3 mm, open, blade type
 Approval: ECE R28



1 Piece



2 Pieces

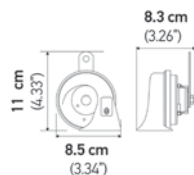

Part Number	Quantity	Description
012010801	2 Pieces	Box (graphic) Trumpets 12 V, 2 x 72 W, 400 / 500 Hz - Universal Diameter Measurements: 8.1 cm 8 x 10.9 cm Blue Horn
012010821	2 Pieces	Box (graphic) Trumpets 12 V, 2 x 72 W, 400 / 500 Hz - Universal Diameter Measurements: 8.1 cm 8 x 10.9 cm Yellow Horn
007424001	1 Piece	Low Tone - Box (yellow) Horn 12 V, 1 x 72 W, 400 - Universal Diameter Measurements: 8.1 cm 8 x 10.9 cm Red Horn
007424011	1 Piece	High Tone - Box (yellow) Horn 12 V, 1 x 72 W, 500 - Universal Diameter Measurements: 8.1 cm 8 x 10.9 cm Red Horn

Product image / Dimensions

Features



TC16S Series - OE Connector



ABS plastic housing and black bracket in galvanized metal.
 Level of acoustic intensity at 2 m distance: 113 dB(A).
 Energy consumption: 2 x 72 W.
 M8 screw horn bracket.
 Operating Temperature: -40° C a 80° C (-40°F a 176°F)
 With flat connections of 6.3 mm, open, blade type
 Approval: ECE R28, CCC

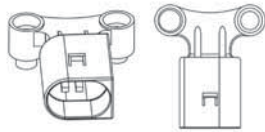

Part Number	Quantity	Description
011225841	2 Pieces.	Horns 12 V, 2 x 72 W, 400 / 500 Hz - AUDI / VOLKSWAGEN Diameter Measurements: 8.6 cm 8.6 x 10.9 cm With specific connector



012010881	2 Pieces.	Horns 12 V, 2 x 72 W, 400 / 500 Hz - BMW / MINI Diameter Measurements: 8.6 cm 8.6 x 10.9 cm With specific connector
-----------	-----------	--

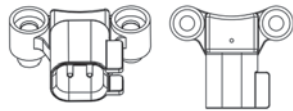

011225921	2 Pieces.	Horns 12 V, 2 x 72 W, 400 / 500 Hz - FORD Diameter Measurements: 8.6 cm 8.6 x 10.9 cm With specific connector
-----------	-----------	--

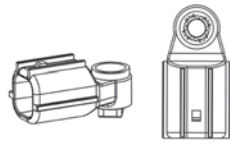

012010911	2 Pieces.	Horns 12 V, 2 x 72 W, 400 / 500 Hz - HONDA Diameter Measurements: 8.6 cm 8.6 x 10.9 cm With specific connector
-----------	-----------	---

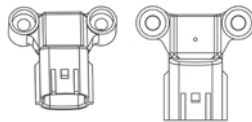

011225901	2 Pieces.	Horns 12 V, 2 x 72 W, 400 / 500 Hz - HYUNDAI / KIA Diameter Measurements: 8.6 cm 8.6 x 10.9 cm With specific connector
-----------	-----------	---

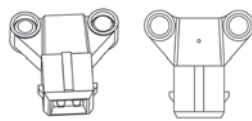

012010891	2 Pieces.	Horns 12 V, 2 x 72 W, 400 / 500 Hz - PEUGEOT Diameter Measurements: 8.6 cm 8.6 x 10.9 cm With specific connector
-----------	-----------	---

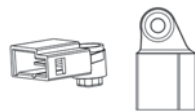

012010901	2 Pieces.	Horns 12 V, 2 x 72 W, 400 / 500 Hz - TOYOTA Diameter Measurements: 8.6 cm 8.6 x 10.9 cm With specific connector
-----------	-----------	--

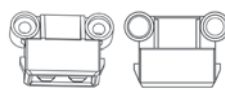

011225851	2 Pieces.	Horns 12 V, 2 x 72 W, 400 / 500 Hz - AUDI / VOLKSWAGEN Diameter Measurements: 8.6 cm 8.6 x 10.9 cm With specific connector
-----------	-----------	---



2 Pieces

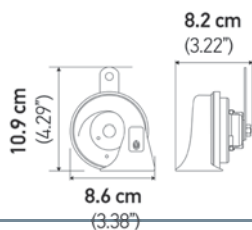

Product image /
Dimensions

Features

TE20C Series - Chrome

Chromed ABS plastic housing and galvanized metal bracket.
 Level of acoustic intensity at 2 m distance: 112 dB(A).
 Energy consumption: 2 x 60 W
 M8 screw horn bracket.
 Operating Temperature: -40° C a 90° C (-40°F a 194°F).
 With flat connections of 6.3 mm, open, blade type.



Part Number	Quantity	Description
007728883	2 Pieces	Trumpets 12 V, 2 x 60 W, 410 / 510 Hz - Universal Diameter Measurements: 8.6 cm 9.1 x 9.7 x 8.7 cm Chrome Horn

Special Edition

 Horn chrome HELLA:
Quality to the last detail

2 Pieces

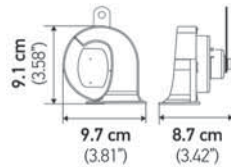
Series TE20



ABS plastic housing and galvanized metal bracket.
 Level of acoustic intensity at 2 m distance: 110 dB(A)
 Energy consumption: 2 x 72 W
 M8 screw horn bracket.
 Operating Temperature: -40° C a 90° C (-40°F a 194°F)
 With flat connections of 6.3 mm, open, blade type



Part Number	Quantity	Description
940800821	2 Pieces	Trumpets 24 V, 2 x 72 W, 410 / 510 Hz - Universal Diameter Measurements: 8.6 cm 9.1 x 9.7 x 8.7 cm Black Horn

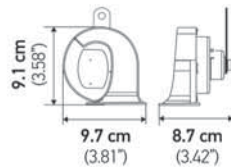

2 Pieces



AIR TRUMPETS

Efficient sound



HELLA compressed air trumpets produce a penetrating and long range sound. Ideal for carriers that need to be heard in traffic.

HELLA trumpets are finished in durable materials, their sound is penetrating, and their design is striking, resistant to inclement weather



Product image / Dimensions	Features
----------------------------	----------



Twin Compressed Air Trumpet



For vehicles with a compressed air brake system.
 Chromed lid and trumpet, matt black base
 Pneumatic operation
 Level of acoustic intensity at 2 m distance: 118 dB(A).
 Energy consumption: 0 - 20 W.
 Suitable for tubular fittings Ø 8 mm.
 2 holes for fixing screws M10.
 Approval: ECE
 Pressure Range: 4 - 8.3 bar

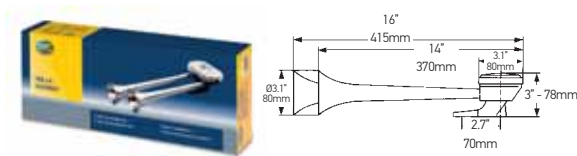

Part Number	Quantity	Description
005411001	1 Piece	Compressed air horn 24 V, 0 -20 W, 300 - 350 Hz - Universal Measurements: 7.8 x 16 x 41.5 cm



Accessories

The horn can be operated in three different ways:

Part Number	Quantity	Description
1 715989001	1 Set	Mounting on the roof of the cab. Drive pulling the pull cable coated, 120 cm long. Traction Valve.
2 715990001	1 Set	Cabin floor mounting. Actuation with the foot. Pedal valve.
3 715991001	1 Set	Mounting in the engine compartment. Drive by pressing Horn button. With flat connections of 6,3 mm, open. Power absorbed: 20W. Electric valve, 24V.



Compressed Air Trumpet



For vehicles with a compressed air brake system.
 Level of acoustic intensity at 2 m distance: 118 dB (A).
 Energy consumption: 35W @ 12V, 50W @ 24V.
 6.3mm flat blade type terminals.
 Robust diecast housing.
 Suitable for tubular fitting Ø 10 mm.
 Pneumatic operation, 2 holes for M10 fixing screws.
 Operating Temperature: -40° C a 90° C (-40°F a 194°F)
 Approval: ECE
 Pressure Range: 6 - 8.3 bar

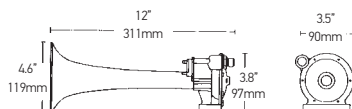

Part Number	Quantity	Description
004206041	1 Piece	Trumpet 12 V, 35 W, 400 Hz - Universal Diameter Measurements: 11.9 cm 9.7 x 9 x 31.1 cm
004206011	1 Piece	Trumpet 24 V, 50 W, 400 Hz - Universal Diameter Measurements: 11.9 cm 9.7 x 9 x 31.1 cm

1 Piece

Product image / Dimensions

Features



NEW



1 Piece

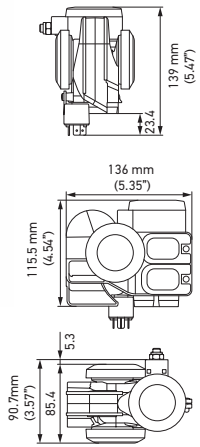

Tornado Electropneumatic Horn CA26



Super compact design with horn and air compressor in one module. The integrated compressor enables immediate sound output. Necessary mounting kits and relay are included. ABS housing. Level of acoustic intensity at 2 m distance: 112 dB(A). Energy consumption: 120 W. Mounting bracket included. Operating Temperature: -40° C a 75° C (-40°F a 167°F) Approval: ECE



Part Number	Quantity	Description
013410081	1 Piece	1 Electropneumatic horn 12 V, 120 W, 520 / 660 Hz - Universal
013410091	1 Piece	1 Electropneumatic horn 24 V, 120 W, 520 / 660 Hz - Universal



1 Piece
1 Relay

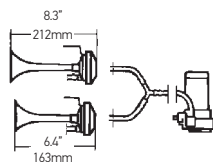

Set of Twin Tone Air Horns



Compressed air horn with ABS plastic body and support in galvanized metal. Level of acoustic intensity at 2 m distance: 118 dB(A). Energy consumption: 240 W. Mounting bracket included. Operating Temperature: -40° C a 90° C (-40°F a 194°F) Approval: ECE



Part Number	Quantity	Description
003001651	1 Set	2 Electric Horns - Pneumatic 12 V, 240 W, 780 / 840 Hz - Universal Length of Trumpets: 16.3 cm 21.2 cm Includes compressor, pressure tubes, bifurcated Piece Fastening and Relay 12 V
003001661	1 Set	2 Electric Trumpets - Pneumatic 24 V, 240 W, 780 / 840 Hz - Universal Length of Trumpets: 16.3 mm 21.2 cm Includes compressor, pressure tubes, bifurcated Piece Fastening and Relay 24 V



1 Piece
1 Relay

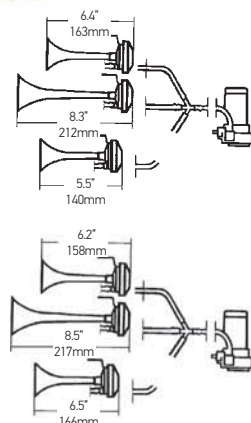

Set of Triple Tone Air Horns



Compressed air horns with ABS plastic body and support in galvanized metal. Level of acoustic intensity at 2 m distance: 118 dB(A). Energy consumption: 240 W. Mounting bracket included. Operating Temperature: -40° C a 90° C (-40°F a 194°F) Approval: ECE



Part Number	Quantity	Description
003001671	1 Set	3 Electric Horns - Pneumatic 12 V, 240 W, 780 / 820 / 880 Hz - Universal Length of Trumpets: 14 cm 16.3 cm 21.2 cm Includes compressor, pressure tubes, bifurcated Piece Fastening and Relay 12 V
003001981	1 Set	3 Electric Trumpets - Pneumatic Melodic Sound 12 V, 240 W, 630 / 795 / 840 Hz - Universal Length of Trumpets: 15.8 cm 16.6 cm 21.7 cm Includes compressor, pressure tubes, bifurcated Piece Fastening and Relay 12 V

Product image /
Dimensions

Features

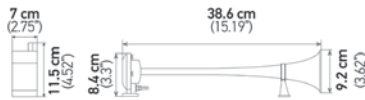

Single Tone Compressed Air Horn



Pneumatic operation
 Level of acoustic intensity at 2 m distance: 115 dB(A).
 Energy consumption: 312 W.
 Robust housing.
 With flat connections of 6.3 mm, open, blade type
 2 holes for M10 fixing screws.
 Pressure Range: 0.98 bar



Part Number	Quantity	Description
013410001	1 Set	Air Horn using compressed air - Single tone 12 V, 312 W - Universal Measurements: 9.2 x 8.4 x 38.6 cm Includes compressor, pressure tubes, Fastening and Relay 12 V

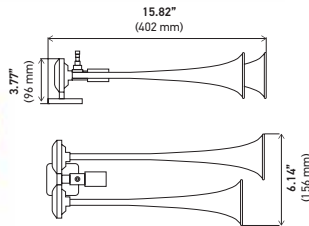

Dual Tone Compressed Air Horn



For vehicles with compressed air braking system.
 Level of acoustic intensity at 2 m distance: 125 dB(A).
 Robust housing.
 With flat connections of 6.3 mm, open, blade type
 Pressure Range: 6 - 8 bar (87 - 116 PSI)



Part Number	Quantity	Description
013410051	1 Piece.	Dual tone compressed air horn - Box 12 V, 41 W - Universal Measurements: 40.2 x 9.6 x 15.6 cm
013410061	1 Piece.	Dual tone compressed air horn - Box 24 V, 77 W - Universal Measurements: 40.2 x 9.6 x 15.6 cm
715991031	1 Set	Replacement solenoid for air trumpet - 12 V
715991041	1 Set	Replacement solenoid for air trumpet - 24 V



1 Piece

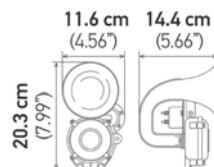

Single Tone Air Horn



For vehicles with a compressed air brake system.
 Pneumatic operation
 Level of acoustic intensity at 2 m distance: 115 dB(A).
 Energy consumption: 120 W.
 Robust Housing
 Suitable for tubular fittings \varnothing 8 mm. 2 holes for M10 fixing screws.
 Pressure Range: 5.88 bar

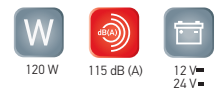

Part Number	Quantity	Description
013410011	1 Piece	Compressed air horn - Single tone 12 - 24 V, 120 W - Universal Measurements: 11.6 x 14.4 x 20.3 cm



BACKUP ALARMS

Safety above all



In some countries, regulations require the installation of a reverse alarm when motor vehicles have obstructed eyesight to the rear. The vehicle must have an audible reverse alarm above the surrounding noise level. Unless, the vehicle is backed up when an observer indicates that it is safe to do so.

All bidirectional machines, such as rollers, compactors, front loaders, bulldozers and similar equipment, must be equipped with a reverse alarm, which will be differentiated from the surrounding noise level and which will be operated as necessary when the machine is in motion. The reverse alarm has to be maintained in operating conditions. Many of the regulations require a sound level greater than 90 dB.



Product image / Dimensions	Features
----------------------------	----------



1 Piece



1 Piece

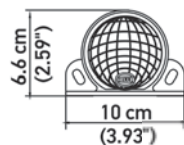

Backup Alarm



Black plastic housing.
 With integrated bracket for universal mounting.
 The level of sound intensity is generated by the electronics of solid bodies.
 Level of acoustic intensity at 2 m distance: 110 dB (A).
 Multivoltage: 9 V - 48 V
 Rated Continuous Current: 0.1 - 0.6 A
 Operating temperature: -40 °C to +85 °C.
 Protection class: IP67 (Resistant to water immersions)
 Approval: ECE R10 / 107 dB



Part Number	Quantity	Description
009148142	1 Piece	Backup Alarm - Plastic blister Multivolt: 9 - 48 V - Universal Protection Class: IP67K Measurements: 10.1 x 3.9 x 6.5 cm
009148141	1 Piece	Backup Alarm - Box Multivolt: 9 - 48 V - Universal Protection Class: IP67K Measurements: 10.1 x 3.9 x 6.5 cm
009148161	1 Piece	Backup Alarm - Box - with grounding strap NEW Multivolt: 9 - 48 V - Universal Protection Class: IP67K Measurements: 10.1 x 3.9 x 6.5 cm
009148221	1 Piece	Backup Alarm - Box - with grounding strap, NEW SAE J994 Type C, 102 dB (A) Multivolt: 9 - 48 V - Universal Protection Class: IP67K Measurements: 10.1 x 3.9 x 6.5 cm

Ask your sales representative about product availability in your region



Backup Alarm BX10



Black plastic housing.
 With integrated bracket for universal mounting.
 Level of acoustic intensity at 2 m distance: 90 dB (A).
 Multivoltage: 12 V - 24 V
 Rated Power Consumption of 5.5 Watts
 Operating temperature: -40 °C to +85 °C.

NEW

1 Piece

Part Number	Quantity	Description
009148501	1 Piece	Backup Alarm BX10 - Box Multivolt: 12-24 V - Universal

Product image / Dimensions

Features



Reverse Alarm



Black steel housing.
 With integrated bracket for universal mounting.
 The level of sound intensity is generated by the solid body electronics.
 Approved against electromagnetic tolerance and according to SAE.
 With protection against reverse polarity and voltage points.
 Operating temperature: -40 ° C to +85 ° C.
 60 signals per minute.
 Protection class: IP5K9K, CE, SAE J994, E11.



Part Number	Quantity	Description
996139001	1 Piece	Reverse Alarm With automatic adaptation to the environment with variable acoustic level. The solid body electronics is automatically set to 5 dB (A) above the ambient acoustic level. With connection cable of 16 cm long Voltage: 12V - 24V. Current consumption: 0.59A - 0.71A. Acoustic level: 87-112 dB (A) (1.2 m). Frequency: 1200 Hz ± 20%.
996139101	1 Piece	Reverse Alarm. With connection cable 16 cm long Voltage: 12V - 36V. Current consumption: 0.4A. Acoustic level: 107 dB (A) (1.2 m). Frequency: 1300 Hz ± 20%.
996139111	1 Piece	Reverse Alarm. With connection cable 16 cm long Voltage: 12V - 36V. Current consumption: 0.4A. Acoustic level: 112 dB (A) (1.2 m). Frequency: 1250 Hz ± 20%.



1 Piece

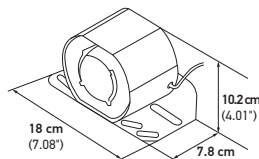

Reverse Alarm



Black plastic housing.
 With integrated bracket for universal mounting.
 The level of sound intensity is generated by the electronic of solid bodies.
 Approved against electromagnetic tolerance and according to SAE.
 With protection against reverse polarity and voltage points.
 Operating temperature: -40 ° C to +85 ° C.
 Frequency: 60 signals per minute; 1250 Hz ± 20% .



Part Number	Quantity	Description
009148001	1 Piece	Reverse Alarm. Voltage: 12V - 24V. Current consumption: 0.1A - 0.2A. Acoustic level: 90 dB (A) (1.2 m), with integrated AMP plug.
009148011	1 Piece	Reverse Alarm. Voltage: 12V - 24V. Current consumption: 0.3A - 0.4A. Acoustic level: 97 dB (A) (1.2 m), with integrated AMP plug.
009148021	1 Piece	Reverse Alarm. Voltage: 12V - 24V. Current consumption: 0.6A - 0.7A. Acoustic level: 107 dB (A) (1.2 m), with integrated AMP plug.



1 Piece

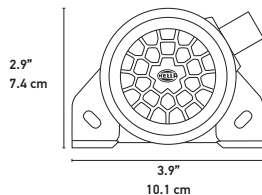

Product image /
Dimensions

Features

New

Horn display

Includes power source, switches and connections

Includes the following products:

009148141 - Backup alarm

011225831 - TC16 (horn set)

012010851 - TE16 (horn set)

004811091 - S130 (horn set)

007728883 - TE20C (horn set)

004811101 - S140 (Horn set)



Part Number	Quantity	Description
358117521	1 Pieza.	Horn display

The exhibitor and its contents may change without notice.

Warning: The high level of sound produced by the speakers and / or bugles may cause discomfort and / or damage to the ears, take precautions

**Available
Now!**

THE ULTIMATE IN THE ART OF RELAYS











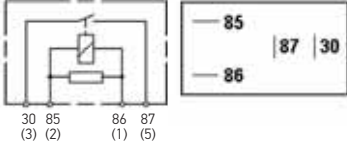

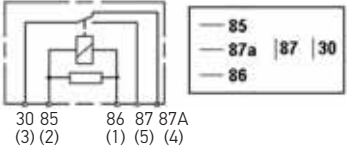

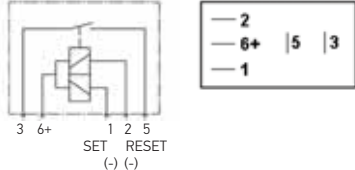

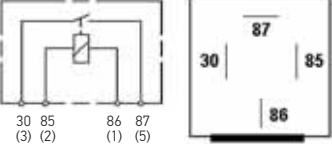

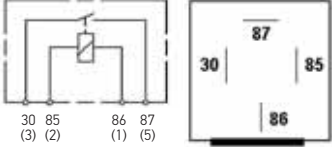

UPDATED!

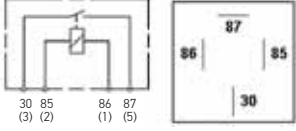

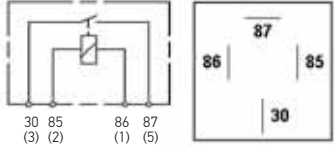

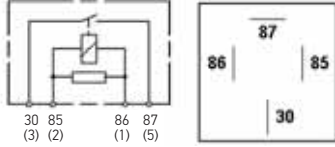

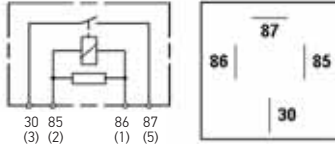

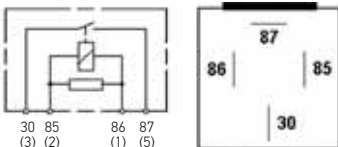
MICROSITE: Consult vehicle specific application in our website for detailed information:

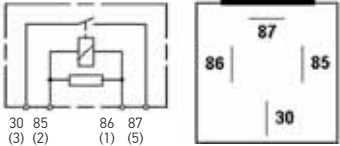

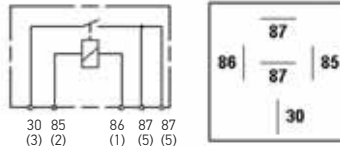

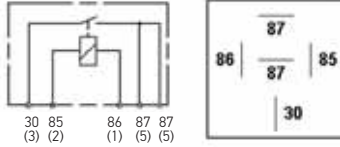

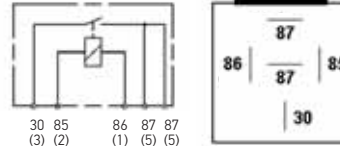

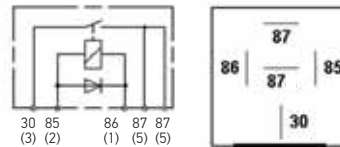
<https://hella.mypartfinder.com/>

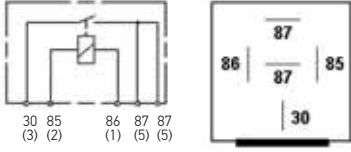

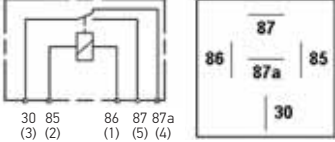

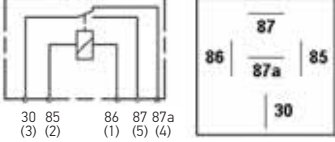

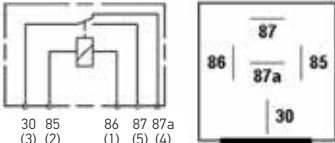

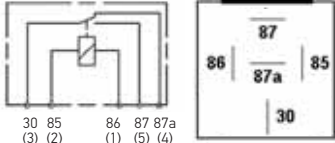

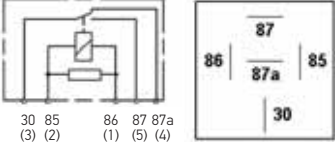

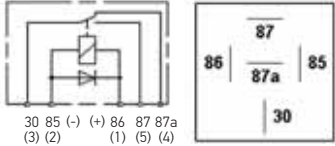

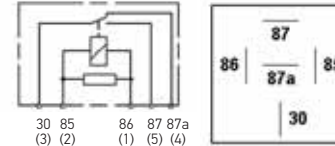

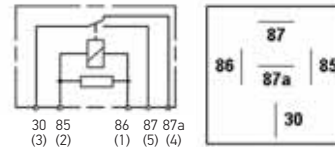

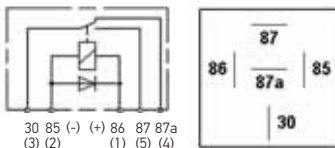

Product image / Dimensions	Features	Part Number	Technical Specifications
Micro Relay ISO 	<ul style="list-style-type: none"> • 12 V • SPST / Form A • 35 Amp • Resistor Coil Suppression 	933766801	Minimum Order Quantity: 1 <hr/> Technical Data Rated Voltage: 12 V Rated Current: 35A at 85°C Contact form: 1 Form A / SPST N/O
Micro Relay ISO 	<ul style="list-style-type: none"> • 12 V • SPDT / Form C • 35 Amp • Resistor Coil Suppression 	965453801	Minimum Order Quantity: 1 <hr/> Technical Data Rated Voltage: 12 V Rated Current: N/O 35A N/C 20A at 85°C Contact form: 1 Form C / SPDT
Micro Relay ISO 	<ul style="list-style-type: none"> • 12 V • SPST / Form A • 30 Amp • Bistable / Magnetic Latching 	933364027	Minimum Order Quantity: 1 <hr/> Technical Data Rated Voltage: 12 V Rated Current: 30A at 85°C Contact form: 1 Form A / SPST N/O
Mini Relay ISO 	<ul style="list-style-type: none"> • 12 V • SPST / Form A • Mounting Bracket • 30 Amp • Alternate Footprint 	965400071 965400077	Minimum Order Quantity: 1 Pack - Minimum Order Quantity: 40 <hr/> Technical Data Voltaje Nominal: 12 V Rated Current: 30A at 85°C Contact form: 1 Form A / SPST N/O
Mini Relay ISO 	<ul style="list-style-type: none"> • 24 V • SPST / Form A • Mounting Bracket • 30 Amp • Alternate Footprint 	965400101	Minimum Order Quantity: 1 <hr/> Technical Data Voltaje Nominal: 24 V Rated Current: 30A at 85°C Contact form: 1 Form A / SPST N/O

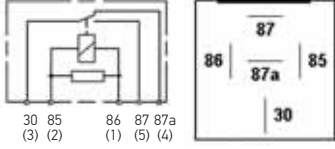

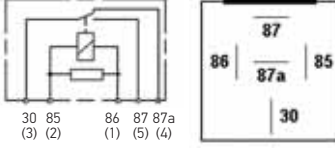

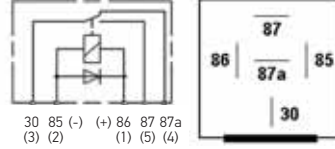

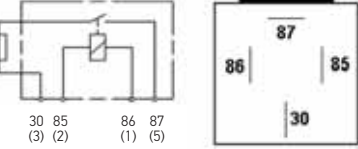

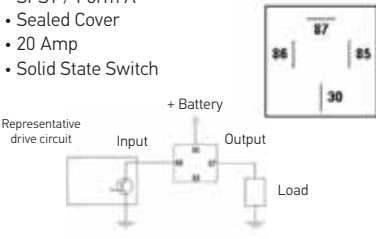
Product image / Dimensions	Features	Part Number	Technical Specifications						
<p>Mini Relay ISO</p> 	<ul style="list-style-type: none"> • 12 V • SPST / Form A • 40 Amp • Dust Cover 	<p>933332451</p> <p>933332457</p>	<p>Minimum Order Quantity: 1</p> <p>Pack - Minimum Order Quantity: 40</p>						
		<p>Technical Data</p> <table border="1"> <tr> <td>Voltaje Nominal</td> <td>12 V</td> </tr> <tr> <td>Rated Current</td> <td>40A at 85°C</td> </tr> <tr> <td>Contact form</td> <td>1 Form A / SPST N/O</td> </tr> </table>		Voltaje Nominal	12 V	Rated Current	40A at 85°C	Contact form	1 Form A / SPST N/O
Voltaje Nominal	12 V								
Rated Current	40A at 85°C								
Contact form	1 Form A / SPST N/O								
<p>Mini Relay ISO</p> 	<ul style="list-style-type: none"> • 24 V • SPST / Form A • 20 Amp • Dust Covers 	<p>933332461</p>	<p>Minimum Order Quantity: 1</p>						
		<p>Technical Data</p> <table border="1"> <tr> <td>Voltaje Nominal</td> <td>24 V</td> </tr> <tr> <td>Rated Current</td> <td>20A at 85°C</td> </tr> <tr> <td>Contact form</td> <td>1 Form A / SPST N/O</td> </tr> </table>		Voltaje Nominal	24 V	Rated Current	20A at 85°C	Contact form	1 Form A / SPST N/O
Voltaje Nominal	24 V								
Rated Current	20A at 85°C								
Contact form	1 Form A / SPST N/O								
<p>Mini Relay ISO</p> 	<ul style="list-style-type: none"> • 12 V • SPST / Form A • Dust Cover • 40 Amp • Resistor Coil Suppression 	<p>933332541</p>	<p>Minimum Order Quantity: 1</p>						
		<p>Technical Data</p> <table border="1"> <tr> <td>Voltaje Nominal</td> <td>12 V</td> </tr> <tr> <td>Rated Current</td> <td>40A at 85°C</td> </tr> <tr> <td>Contact form</td> <td>1 Form A / SPST N/O</td> </tr> </table>		Voltaje Nominal	12 V	Rated Current	40A at 85°C	Contact form	1 Form A / SPST N/O
Voltaje Nominal	12 V								
Rated Current	40A at 85°C								
Contact form	1 Form A / SPST N/O								
<p>Mini Relay ISO</p> 	<ul style="list-style-type: none"> • 24 V • SPST / Form A • Dust Covers • 20 Amp • Resistor Coil Suppression 	<p>007957001</p>	<p>Minimum Order Quantity: 1</p>						
		<p>007957007</p>	<p>Pack - Minimum Order Quantity: 200</p>						
		<p>Technical Data</p> <table border="1"> <tr> <td>Voltaje Nominal</td> <td>24 V</td> </tr> <tr> <td>Rated Current</td> <td>20A at 85°C</td> </tr> <tr> <td>Contact form</td> <td>1 Form A / SPST N/O</td> </tr> </table>		Voltaje Nominal	24 V	Rated Current	20A at 85°C	Contact form	1 Form A / SPST N/O
Voltaje Nominal	24 V								
Rated Current	20A at 85°C								
Contact form	1 Form A / SPST N/O								
<p>Mini Relay ISO</p> 	<ul style="list-style-type: none"> • 12 V • SPST / Form A • Mounting Bracket • 40 Amp • Resistor Coil Suppression 	<p>007791021</p>	<p>Minimum Order Quantity: 1</p>						
		<p>007791027</p>	<p>Pack - Minimum Order Quantity: 200</p>						
		<p>Technical Data</p> <table border="1"> <tr> <td>Voltaje Nominal</td> <td>12 V</td> </tr> <tr> <td>Rated Current</td> <td>40A at 85°C</td> </tr> <tr> <td>Contact form</td> <td>1 Form A / SPST N/O</td> </tr> </table>		Voltaje Nominal	12 V	Rated Current	40A at 85°C	Contact form	1 Form A / SPST N/O
Voltaje Nominal	12 V								
Rated Current	40A at 85°C								
Contact form	1 Form A / SPST N/O								

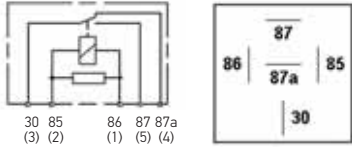

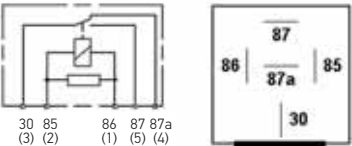

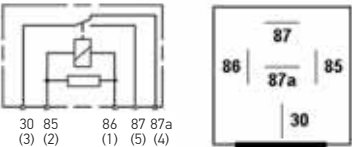

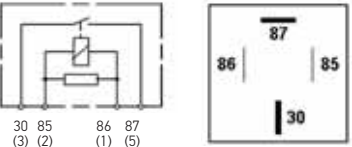
Product image / Dimensions	Features	Part Number	Technical Specifications
Mini Relay ISO 	<ul style="list-style-type: none"> • 24 V • SPST / Form A • Mounting Bracket • 20 Amp • Resistor Coil Suppression 	007957011 007957017	Minimum Order Quantity: 1 Pack - Minimum Order Quantity: 200
Mini Relay ISO 	<ul style="list-style-type: none"> • 12 V • SPST / Form A • Dust Cover • 40 Amp • Dual Output (2x Terminal 87) 	933791161 933791167	Minimum Order Quantity: 1 Pack - Minimum Order Quantity: 40
Mini Relay ISO 	<ul style="list-style-type: none"> • 24 V • SPST / Form A • Dust Cover • 20 Amp • Dual Output (2x Terminal 87) 	933791141	Minimum Order Quantity: 1
Mini Relay ISO 	<ul style="list-style-type: none"> • 12 V • SPST / Form A • Mounting Bracket • 40 Amp • Dual Output (2x Terminal 87) 	933791121 933791127	Minimum Order Quantity: 1 Pack - Minimum Order Quantity: 40
Mini Relay ISO 	<ul style="list-style-type: none"> • 12 V • SPST / Form A • Mounting Bracket • 40 Amp • Dual Output (2x Terminal 87) • Diode Coil Suppression 	933791151	Minimum Order Quantity: 1

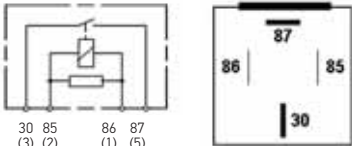
Product image / Dimensions	Features	Part Number	Technical Specifications						
<p>Mini Relay ISO</p> 	<ul style="list-style-type: none"> • 24 V • SPST / Form A • Mounting Bracket • 20 Amp • Dual output (2 x Terminal 87) 	<p>933791131</p> <p>Technical Data</p>	<p>Minimum Order Quantity: 1</p> <table border="1"> <tr> <td>Voltage Nominal</td> <td>24 V</td> </tr> <tr> <td>Rated Current</td> <td>20A at 85°C</td> </tr> <tr> <td>Contact form</td> <td>1 Form A / SPST N/O (2 x Terminal 87)</td> </tr> </table>	Voltage Nominal	24 V	Rated Current	20A at 85°C	Contact form	1 Form A / SPST N/O (2 x Terminal 87)
Voltage Nominal	24 V								
Rated Current	20A at 85°C								
Contact form	1 Form A / SPST N/O (2 x Terminal 87)								
<p>Mini Relay ISO</p> 	<ul style="list-style-type: none"> • 12 V • SPDT / Form C • 40 Amp • Dust cover 	<p>933332401</p> <p>933332407</p> <p>Technical Data</p>	<p>Minimum Order Quantity: 1</p> <p>Pack - Minimum Order Quantity: 40</p> <table border="1"> <tr> <td>Voltage Nominal</td> <td>12 V</td> </tr> <tr> <td>Rated Current</td> <td>N/O 40A N/C 20A at 85°C</td> </tr> <tr> <td>Contact form</td> <td>1 Form C / SPDT</td> </tr> </table>	Voltage Nominal	12 V	Rated Current	N/O 40A N/C 20A at 85°C	Contact form	1 Form C / SPDT
Voltage Nominal	12 V								
Rated Current	N/O 40A N/C 20A at 85°C								
Contact form	1 Form C / SPDT								
<p>Mini Relay ISO</p> 	<ul style="list-style-type: none"> • 24 V • SPDT / Form C • 20 Amp • Dust cover 	<p>933332421</p> <p>933332427</p> <p>Technical Data</p>	<p>Minimum Order Quantity: 1</p> <p>Minimum Order Quantity: 40</p> <table border="1"> <tr> <td>Voltage Nominal</td> <td>24 V</td> </tr> <tr> <td>Rated Current</td> <td>N/O 20A N/C 10A at 85°C</td> </tr> <tr> <td>Contact form</td> <td>1 Form C / SPDT</td> </tr> </table>	Voltage Nominal	24 V	Rated Current	N/O 20A N/C 10A at 85°C	Contact form	1 Form C / SPDT
Voltage Nominal	24 V								
Rated Current	N/O 20A N/C 10A at 85°C								
Contact form	1 Form C / SPDT								
<p>Mini Relay ISO</p> 	<ul style="list-style-type: none"> • 12 V • SPDT / Form C • 40 Amp • Mounting Bracket 	<p>933332361</p> <p>Technical Data</p>	<p>Minimum Order Quantity: 1</p> <table border="1"> <tr> <td>Voltage Nominal</td> <td>12 V</td> </tr> <tr> <td>Rated Current</td> <td>N/O 40A N/C 20A at 85°C</td> </tr> <tr> <td>Contact form</td> <td>1 Form C / SPDT</td> </tr> </table>	Voltage Nominal	12 V	Rated Current	N/O 40A N/C 20A at 85°C	Contact form	1 Form C / SPDT
Voltage Nominal	12 V								
Rated Current	N/O 40A N/C 20A at 85°C								
Contact form	1 Form C / SPDT								
<p>Mini Relay ISO</p> 	<ul style="list-style-type: none"> • 24 V • SPDT / Form C • 20 Amp • Mounting Bracket 	<p>933332411</p> <p>933332417</p> <p>Technical Data</p>	<p>Minimum Order Quantity: 1</p> <p>Pack - Minimum Order Quantity: 40</p> <table border="1"> <tr> <td>Voltage Nominal</td> <td>24 V</td> </tr> <tr> <td>Rated Current</td> <td>N/O 20A N/C 10A at 85°C</td> </tr> <tr> <td>Contact form</td> <td>1 Form C / SPDT</td> </tr> </table>	Voltage Nominal	24 V	Rated Current	N/O 20A N/C 10A at 85°C	Contact form	1 Form C / SPDT
Voltage Nominal	24 V								
Rated Current	N/O 20A N/C 10A at 85°C								
Contact form	1 Form C / SPDT								

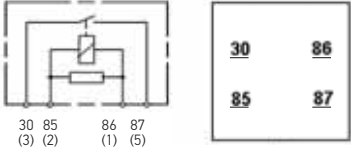
Product image / Dimensions	Features	Part Number	Technical Specifications
Mini Relay ISO 	<ul style="list-style-type: none"> • 12 V • SPDT / Form C • Dust cover • 40 Amp • Resistor Coil Suppression 	93332641	Minimum Order Quantity: 1
		Technical Data	
		Voltaje Nominal	12 V
		Rated Current	N/O 40A N/C 20A at 85°C
		Contact form	1 Form C / SPDT
Mini Relay ISO 	<ul style="list-style-type: none"> • 12 V • SPDT / Form C • Dust cover • 40 Amp • Diode Coil Suppression • Dust Cover 	007794041	Minimum Order Quantity: 1
		007794047	Pack - Minimum Order Quantity: 200
		Technical Data	
		Voltaje Nominal	12 V
		Rated Current	N/O 40A N/C 20A at 85°C
		Contact form	1 Form C / SPDT
Mini Relay ISO 	<ul style="list-style-type: none"> • 12 V • SPDT / Form C • Sealed cover • 40 Amp • Resistor Coil Suppression 	931680901	Minimum Order Quantity: 1
		931680017	Pack - Minimum Order Quantity: 360
		Technical Data	
		Voltaje Nominal	12 V
		Rated Current	N/O 40A N/C 20A at 85°C
		Contact form	1 Form C / SPDT
Mini Relay ISO 	<ul style="list-style-type: none"> • 24 V • SPDT / Form C • Dust cover • 20 Amp • Resistor Coil Suppression 	93332611	Minimum Order Quantity: 1
		Technical Data	
		Voltaje Nominal	24 V
		Rated Current	N/O 20A N/C 10A at 85°C
		Contact form	1 Form C / SPDT
Mini Relay ISO 	<ul style="list-style-type: none"> • 24 V • SPDT / Form C • Dust cover • 20 Amp • Diode Coil Suppression 	93332441	Minimum Order Quantity: 1
		93332447	Minimum Order Quantity: 40
		Technical Data	
		Voltaje Nominal	24 V
		Rated Current	N/O 20A N/C 10A at 85°C
		Contact form	1 Form C / SPDT

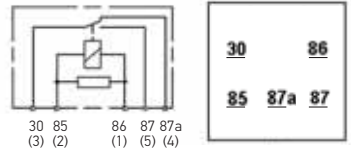
Product image / Dimensions	Features	Part Number	Technical Specifications
<p>Mini Relay ISO</p> 	<ul style="list-style-type: none"> • 12 V • SPDT / Form C • Mounting Bracket • 40 Amp • Resistor Coil Suppression 	<p>93332661</p>	<p>Minimum Order Quantity: 1</p>
<p>Technical Data</p>		<p>Voltaje Nominal</p>	<p>12 V</p>
<p>Rated Current</p>		<p>Contact form</p>	<p>N/O 40A N/C 20A at 85°C</p>
<p>1 Form C / SPDT</p>			
<p>Mini Relay ISO</p> 	<ul style="list-style-type: none"> • 24 V • SPDT / Form C • Mounting Bracket • 20 Amp • Resistor Coil Suppression 	<p>93332701</p>	<p>Minimum Order Quantity: 1</p>
<p>Technical Data</p>		<p>Voltaje Nominal</p>	<p>24 V</p>
<p>Rated Current</p>		<p>Contact form</p>	<p>N/O 20A N/C 10A at 85°C</p>
<p>1 Form C / SPDT</p>			
<p>Mini Relay ISO</p> 	<ul style="list-style-type: none"> • 24 V • SPDT / Form C • Mounting Bracket • 20 Amp • Diode Coil Suppression 	<p>93332681</p>	<p>Minimum Order Quantity: 1</p>
<p>Technical Data</p>		<p>Voltaje Nominal</p>	<p>24 V</p>
<p>Rated Current</p>		<p>Contact form</p>	<p>N/O 20A N/C 10A at 85°C</p>
<p>1 Form C / SPDT</p>			
<p>Mini Relay ISO with built-in 25A fuse</p> 	<ul style="list-style-type: none"> • 12 V • SPST / Form A • Mounting Bracket • 30 Amp • With Built-in 25Amp Fuse 	<p>93332801</p>	<p>Minimum Order Quantity: 1</p>
<p>Technical Data</p>		<p>Voltaje Nominal</p>	<p>12 V</p>
<p>Rated Current</p>		<p>Contact form</p>	<p>30A at 23°C</p>
<p>1 Form A / SPST N/O</p>			
<p>Solid State Mini Relay ISO</p> 	<ul style="list-style-type: none"> • 12 V • SPST / Form A • Sealed Cover • 20 Amp • Solid State Switch 	<p>931774031</p>	<p>Minimum Order Quantity: 1</p>
<p>Technical Data</p>		<p>931774037</p>	<p>Pack - Minimum Order Quantity: 189</p>
<p>Voltaje Nominal</p>		<p>Rated Current</p>	<p>12 V</p>
<p>Rated Current</p>		<p>Contact form</p>	<p>20A at 85°C</p>
<p>1 Form A / SPST N/O</p>			

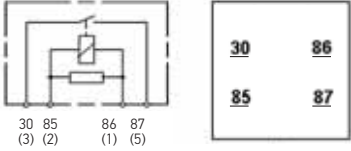
Product image / Dimensions	Features	Part Number	Technical Specifications
Mini Relay ISO 	<ul style="list-style-type: none"> • 12 V • SPDT / Form C • 40 Amp • Resistor Coil Suppression • Weatherproof Cover 	007794931 007794327 Technical Data Voltage Nominal Rated Current Contact form Relay universal mounting bracket universal H84975001 960975001	Minimum Order Quantity: 1 Pack - Minimum Order Quantity: 150 12 V N/O 40A N/C 20A at 85°C 1 Form C / SPDT Quantity: 10 pieces Quantity: 100 pieces
Mini Relay ISO 	<ul style="list-style-type: none"> • 12 V • SPDT / Form C • Mounting Bracket • 40 Amp • Resistor Coil Suppression • Weatherproof Cover 	007794911 (007794301) 007794307 Technical Data Voltage Nominal Rated Current Contact form	Minimum Order Quantity: 1 Pack - Minimum Order Quantity: 150 12 V N/O 40A N/C 20A at 85°C 1 Form C / SPDT
Mini Relay ISO 	<ul style="list-style-type: none"> • 24 V • SPDT / Form C • Mounting Bracket • 20 Amp • Resistor Coil Suppression • Weatherproof Cover 	93332201 93332207 Technical Data Voltage Nominal Rated Current Contact form	Minimum Order Quantity: 1 Pack - Minimum Order Quantity: 80 24 V N/O 20A N/C 10A at 85°C 1 Form C / SPDT
Mini ISO Power Relay 	<ul style="list-style-type: none"> • 12 V • SPST / Form A • Dust cover • 50 Amp • Resistor Coil Suppression 	93332531 Technical Data Voltage Nominal Rated Current Contact form	Minimum Order Quantity: 1 12 V 50A at 85°C 1 Form A / SPST N/O
Mini ISO Power Relay 	<ul style="list-style-type: none"> • 12 V • SPST / Form A • Mounting Bracket • 50 Amp • Resistor Coil Suppression 	93332521 Technical Data Voltage Nominal Rated Current Contact form	Minimum Order Quantity: 1 12 V 50A at 85°C 1 Form A / SPST N/O

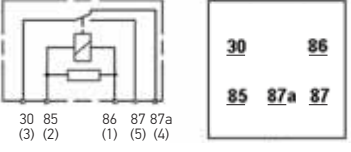
Product image / Dimensions	Features	Part Number	Technical Specifications
Micro Relay 280 	<ul style="list-style-type: none"> • 12 V • SPST / Form A • 30 Amp • Resistor Coil Suppression • Dust Cover 	933332571	Minimum Order Quantity: 1 Technical Data Voltage Nominal: 12 V Rated Current: 30A at 125°C Contact form: 1 Form A / SPST N/O
Micro Relay 280 	<ul style="list-style-type: none"> • 12 V • SPDT / Form C • 30 Amp • Resistor Coil Suppression • Dust Cover 	933332581	Minimum Order Quantity: 1 Technical Data Voltage Nominal: 12 V Rated Current: N/O 30A N/C 20A at 125°C Contact form: 1 Form C / SPDT
Micro Relay 280 	<ul style="list-style-type: none"> • 12 V • SPST / Form A • 35 Amp • Resistor Coil Suppression • Dust Cover 	933332591	Minimum Order Quantity: 1 Technical Data Voltage Nominal: 12 V Rated Current: 35A at 125°C Contact form: 1 Form A / SPST N/O
Micro Relay 280 	<ul style="list-style-type: none"> • 12 V • SPDT / Form C • 35 Amp • Resistor Coil Suppression • Dust Cover 	933332601	Minimum Order Quantity: 1 Technical Data Voltage Nominal: 12 V Rated Current: N/O 35A N/C 20A at 125°C Contact form: 1 Form C / SPDT

Product image / Dimensions	Features	Part Number	Technical Specifications
----------------------------	----------	-------------	--------------------------

Mini Relay 280

- 12 V
- SPDT / Form C
- Mounting Bracket
- 35 Amp
- Weatherproof Cover
- Resistor Coil Suppression

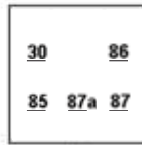
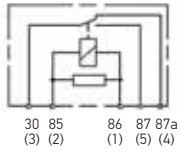

With mounting bracket

931410082 (H41410081)

Minimum Order Quantity: 1

931410087

Pack - Minimum Order Quantity: 80

Without mounting bracket

931410901 (H41410051)

Minimum Order Quantity: 1

931410057

Pack - Minimum Order Quantity: 80

Technical Data

Voltage Nominal	12 V
Rated Current	N/O 35A N/C 20A at 85°C
Contact form	1 Form C / SPDT

Relay universal mounting bracket universal

358112031

Quantity: 10 pieces

931489901

Quantity: 100 pieces

Mini Relay ISO Heavy Duty

- 12 V
- SPST / Form A
- 60 Amp
- Mounting Bracket

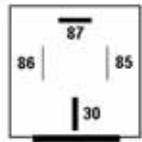
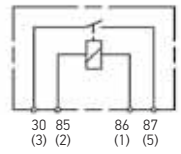
003437081

Minimum Order Quantity: 1

003437087

Pack - Minimum Order Quantity: 120

Technical Data

Voltage Nominal	12 V
Rated Current	60A at 85°C
Contact form	1 Form A / SPST N/O

Mini Relay ISO Heavy Duty

- 24 V
- SPST / Form A
- 60 Amp
- Mounting Bracket

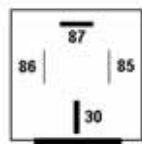
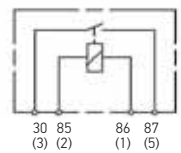
003437092 (H41437091)

Minimum Order Quantity: 1

003437097

Pack - Minimum Order Quantity: 120

Technical Data

Voltage Nominal	24 V
Rated Current	60A at 85°C
Contact form	1 Form A / SPST N/O



Product image / Dimensions	Features	Part Number	Technical Specifications
----------------------------	----------	-------------	--------------------------

Flasher
2 Terminals

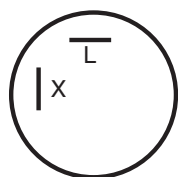

Common Pin Designations

Terminal	Description
49/X	Flashing input (+)
49a/L	Flasher output (+) to lamps or indicator switch
30b	Flasher input (+) from hazard switch
31	Ground (-)
C/C1/CP/P	Vehicle pilot lamp output (+)
C2	1st trailer pilot lamp output (+)
C3	2nd trailer pilot lamp output (+)

Part No.	Description
961553151	2 Pin Flasher Unit - 12 V (Single)
961553157	2 Pin Flasher Unit - 12 V (Bulk 50 Pieces)

High capacity flasher with 6 bulb maximum.
Suitable for hazard warning applications.
Max Load: 12 lamps / 25 Amps (Hazard)
Bracket: H84677001

Flasher
3 Terminals

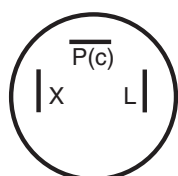

Part No.	Description
961553161	3 Pin Flasher Unit - 12 V (Single)
961553167	3 Pin Flasher Unit - 12 V (Bulk 50 Pieces)

High capacity flasher with 6 bulb maximum.
Suitable for hazard warning applications.
Max Load: 12 lamps / 25 Amps (Hazard)
Bracket: H84677001

961553171	3 Pin Flasher Unit - 24 V (Single)
------------------	------------------------------------





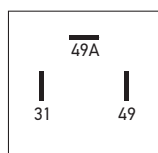



High capacity flasher with 5 bulb maximum.
Suitable for hazard warning applications.
Max Load: 10 lamps SAE # 1683 (Hazard)
Bracket: H84677001

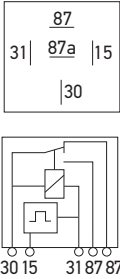

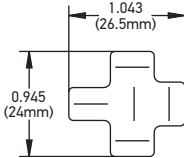
Flasher
3 Terminals

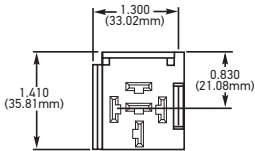

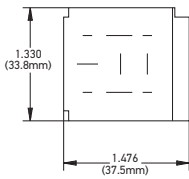
931675911 (H42675031)	3 Pin Flasher Unit - 12 V (Individual)
931675037	3 Pin Flasher Unit - 12 V (Bulk 210 pieces)

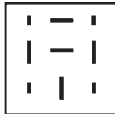
High capacity flasher with 8 bulb maximum
Suitable for hazard warning applications
Max. Load: 16 Bulbs (Hazard)

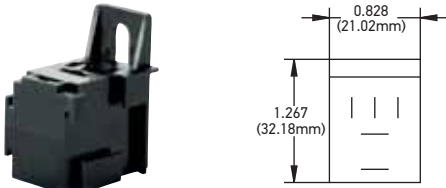
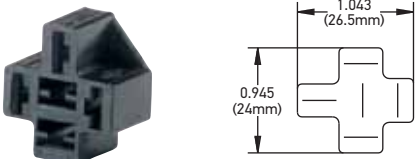
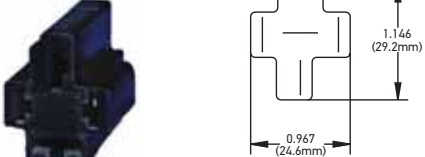
Product image / Dimensions	Features															
<p>Ajustable Control Time Delay Unit</p>  	<p>996152131 Adjustable Control Time Delay Unit - Delay on Release - 12 V</p> <p>996152141 Adjustable Control Time Delay Unit - Delay on Release - 24 V</p> <p>996152151 Adjustable Control Time Delay Unit - Delay on Operate - 12 V</p> <p>996152161 Adjustable Control Time Delay Unit - Delay on Operate - 24 V</p> <p>Designed for a wide range of applications requiring a time delayed switch on or off.</p> <p>Time Delay Range: 0 to 900 seconds</p> <table border="1" data-bbox="639 613 1482 768"> <thead> <tr> <th>S1</th> <th>S2</th> <th>T(s)</th> </tr> </thead> <tbody> <tr> <td>Off</td> <td>Off</td> <td>100...900</td> </tr> <tr> <td>On</td> <td>On</td> <td>14...110</td> </tr> <tr> <td>On</td> <td>Off</td> <td>2.5...14</td> </tr> <tr> <td>Off</td> <td>On</td> <td>0...2.5</td> </tr> </tbody> </table>	S1	S2	T(s)	Off	Off	100...900	On	On	14...110	On	Off	2.5...14	Off	On	0...2.5
S1	S2	T(s)														
Off	Off	100...900														
On	On	14...110														
On	Off	2.5...14														
Off	On	0...2.5														
<p>Relay Socket - Mini ISO</p>  	<p>5 terminals, printed circuit board</p> <table border="1" data-bbox="639 860 1482 972"> <tbody> <tr> <td>358112171 (H84989031)</td> <td>Quantity: 1 piece</td> </tr> <tr> <td>358112111 (H84989037)</td> <td>Quantity: 50 pieces</td> </tr> <tr> <td>358112321 (U84989037)</td> <td>Quantity: 2500 pieces</td> </tr> </tbody> </table>	358112171 (H84989031)	Quantity: 1 piece	358112111 (H84989037)	Quantity: 50 pieces	358112321 (U84989037)	Quantity: 2500 pieces									
358112171 (H84989031)	Quantity: 1 piece															
358112111 (H84989037)	Quantity: 50 pieces															
358112321 (U84989037)	Quantity: 2500 pieces															
<p>Relay Socket - Mini ISO</p>  	<p>Bracket mount, connector block</p> <table border="1" data-bbox="639 1167 1482 1279"> <tbody> <tr> <td>358112141 (H84989011)</td> <td>Quantity: 1 piece</td> </tr> <tr> <td>358112131 (H84989017)</td> <td>Quantity: 50 pieces</td> </tr> <tr> <td>358112301 (U84989017)</td> <td>Quantity: 1000 pieces</td> </tr> </tbody> </table>	358112141 (H84989011)	Quantity: 1 piece	358112131 (H84989017)	Quantity: 50 pieces	358112301 (U84989017)	Quantity: 1000 pieces									
358112141 (H84989011)	Quantity: 1 piece															
358112131 (H84989017)	Quantity: 50 pieces															
358112301 (U84989017)	Quantity: 1000 pieces															
<p>Relay Socket - Mini ISO</p>  	<p>5 or 9 terminals, bracket mount, connector block</p> <table border="1" data-bbox="639 1464 1482 1541"> <tbody> <tr> <td>003526001</td> <td>Quantity: 5 pieces</td> </tr> <tr> <td>003526002</td> <td>Quantity: 50 pieces</td> </tr> </tbody> </table>	003526001	Quantity: 5 pieces	003526002	Quantity: 50 pieces											
003526001	Quantity: 5 pieces															
003526002	Quantity: 50 pieces															
<p>Relay Socket - 9 pins</p>  	<p>SAE relay socket, 9 pins</p> <p>Suitable for 2 flat plugs of 6.3 mm, 2 of 9.5 mm and 4 of 2.8 mm.</p> <table border="1" data-bbox="639 1839 1482 1872"> <tbody> <tr> <td>183161002</td> <td>Quantity: 5 pieces</td> </tr> </tbody> </table>	183161002	Quantity: 5 pieces													
183161002	Quantity: 5 pieces															

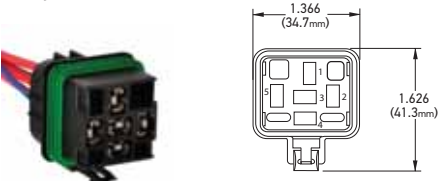
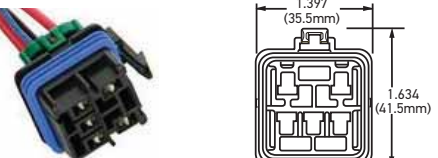
Product image / Dimensions	Part Number	Description						
<p>Relay Socket - Micro ISO</p> 	<p>5 or 9 terminals, bracket mount</p> <table border="1" data-bbox="612 342 1453 461"> <tr> <td>358112161 (H84702001)</td> <td>Quantity: 1 piece</td> </tr> <tr> <td>358112091 (H84702007)</td> <td>Quantity: 50 pieces</td> </tr> <tr> <td>358112241 (U84702007)</td> <td>Quantity: 2250 pieces</td> </tr> </table>	358112161 (H84702001)	Quantity: 1 piece	358112091 (H84702007)	Quantity: 50 pieces	358112241 (U84702007)	Quantity: 2250 pieces	
358112161 (H84702001)	Quantity: 1 piece							
358112091 (H84702007)	Quantity: 50 pieces							
358112241 (U84702007)	Quantity: 2250 pieces							
<p>Relay socket - Mini ISO</p> 	<p>Wire harness connector</p> <table border="1" data-bbox="612 629 1453 748"> <tr> <td>358112181 (H84989021)</td> <td>Quantity: 1 piece</td> </tr> <tr> <td>358112121 (H84989027)</td> <td>Quantity: 50 pieces</td> </tr> <tr> <td>358112311 (U84989027)</td> <td>Quantity: 1000 pieces</td> </tr> </table>	358112181 (H84989021)	Quantity: 1 piece	358112121 (H84989027)	Quantity: 50 pieces	358112311 (U84989027)	Quantity: 1000 pieces	
358112181 (H84989021)	Quantity: 1 piece							
358112121 (H84989027)	Quantity: 50 pieces							
358112311 (U84989027)	Quantity: 1000 pieces							
<p>Relay socket - Mini ISO</p> 	<p>High current (50A), wire harness connector</p> <table border="1" data-bbox="612 875 1453 994"> <tr> <td>358112191 (H84703001)</td> <td>Quantity: 1 piece</td> </tr> <tr> <td>358112151 (H84703007)</td> <td>Quantity: 50 pieces</td> </tr> <tr> <td>358112251 (U84703007)</td> <td>Quantity: 700 pieces</td> </tr> </table>	358112191 (H84703001)	Quantity: 1 piece	358112151 (H84703007)	Quantity: 50 pieces	358112251 (U84703007)	Quantity: 700 pieces	
358112191 (H84703001)	Quantity: 1 piece							
358112151 (H84703007)	Quantity: 50 pieces							
358112251 (U84703007)	Quantity: 700 pieces							
<p>Relay Socket - Mini ISO</p> 	<p>Weatherproof relay connector kit</p> <table border="1" data-bbox="612 1115 1453 1149"> <tr> <td>358112101 (H84709011)</td> <td>Quantity: 1 piece</td> </tr> </table>	358112101 (H84709011)	Quantity: 1 piece					
358112101 (H84709011)	Quantity: 1 piece							
<p>Relay Socket - Mini ISO</p> 	<p>Weatherproof relay connector with 12" leads</p> <table border="1" data-bbox="612 1373 1453 1406"> <tr> <td>358114921 (H84709001)</td> <td>Quantity: 1 pieces</td> </tr> </table>	358114921 (H84709001)	Quantity: 1 pieces					
358114921 (H84709001)	Quantity: 1 pieces							
<p>Relay Socket - Mini 280</p> 	<p>Weatherproof relay connector with 12" leads</p> <table border="1" data-bbox="612 1641 1453 1675"> <tr> <td>358114931 (H84708001)</td> <td>Quantity: 1 pieces</td> </tr> </table>	358114931 (H84708001)	Quantity: 1 pieces					
358114931 (H84708001)	Quantity: 1 pieces							

Product image / Dimensions	Part Number	Description
----------------------------	-------------	-------------

Female Terminals

Female Terminals with Catch

Part No.	AWG wire	Blade size	Package Quantity
172616902 (H84991151)	10 - 12	.375" (9.5mm)	50
172615007	10 - 12	.375" (9.5mm)	2,000
172615902 (H84991141)	6 - 10	.375" (9.5mm)	50
172616007	6 - 10	.375" (9.5mm)	1,800
701235033	14 - 16	.250" (6.3mm)	100
701235034	14 - 16	.250" (6.3mm)	1,500
733815003	18	.188" (4.8mm)	100
744817003	14 - 20	.110" (2.8mm)	100

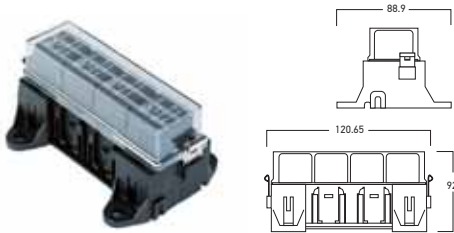
Relay Box - Mini ISO

4-Gang Mini ISO Relay Box (Single)

Splashproof relay boxed
 Snap-fit clear plastic cover
 O-Ring sealed, holds four plug-in type relays
 Removable mounting feet
 Multiple boxedes can be snapped together

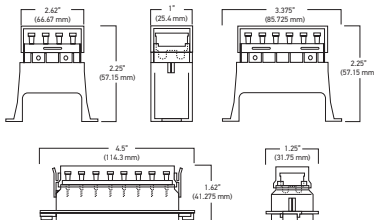
358112221 (H84988001)	Relay Box Mini ISO, 4-gang
358112211 (H84988011)	Relay Box Mini ISO, 7-gang

Fuse Box

Bottom tap connections

Splashproof fuse boxed
 Snap-fit clear plastic cover
 O-Ring sealed
 Max load: 20a per circuit
 Fuses not included

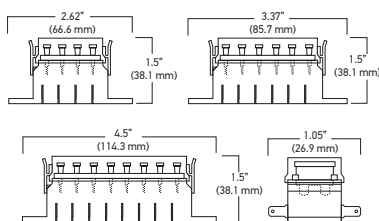
358115881 (H84960061)	Fuse boxed - 4 terminals
358115901 (H84960081)	Fuse boxed - 6 terminals
358115801 (H84960101)	Fuse boxed - 8 terminals

Fuse Box

Side connections

Splashproof Fuse Box
 Snap-Fit Clear Plastic Cover
 O-ring Sealed
 Max Load: 20A per circuit
 Fuses not included

358115891 (H84960071)	Fuse boxed - 4 terminals, lateral connection
358115781 (H84960091)	Fuse boxed - 6 terminals, lateral connection
358115791 (H84960111)	Fuse boxed - 8 terminals, lateral connection



Product image / Dimensions	Part Number	Description											
<p>Fuse boxed</p> 	<p>16 Gang fuse boxed - Bottom tab connections</p> <p>Splashproof Fuse Box Snap-Fit Clear Plastic Cover O-ring Sealed Removable Mounting Feet Boxes Can Be Snapped Together for 32,48 Fuses etc. Max Load: 20A per circuit Fuses not included</p>	<table border="1"> <tr> <td>358115871 (H84960051)</td> <td>Fuse Box - 16 terminals, lateral connection</td> </tr> </table>	358115871 (H84960051)	Fuse Box - 16 terminals, lateral connection									
358115871 (H84960051)	Fuse Box - 16 terminals, lateral connection												
<p>Fuse holder MAXI</p> 	<p>Splash proof For MAXI fuses 8 AWG wire 32 cm in length</p>	<table border="1"> <tr> <td>358129911</td> <td>MAXI Fuse holder</td> <td>Quantity: 1 piece</td> </tr> <tr> <td>358129902</td> <td>MAXI Fuse holder</td> <td>Quantity: 5 pieces</td> </tr> </table>	358129911	MAXI Fuse holder	Quantity: 1 piece	358129902	MAXI Fuse holder	Quantity: 5 pieces					
358129911	MAXI Fuse holder	Quantity: 1 piece											
358129902	MAXI Fuse holder	Quantity: 5 pieces											
<p>Fuse holder STANDARD</p> 	<p>Splash proof For STANDARD fuses 12 AWG wire 32 cm in length</p>	<table border="1"> <tr> <td>358129931</td> <td>STANDARD Fuse holder</td> <td>Quantity: 1 piece</td> </tr> <tr> <td>358129921</td> <td>STANDARD Fuse holder</td> <td>Quantity: 10 pieces</td> </tr> </table>	358129931	STANDARD Fuse holder	Quantity: 1 piece	358129921	STANDARD Fuse holder	Quantity: 10 pieces					
358129931	STANDARD Fuse holder	Quantity: 1 piece											
358129921	STANDARD Fuse holder	Quantity: 10 pieces											
<p>MINI Fuse assortment</p> 	<p>Assortment of fast acting fuses. It contains: 20 pieces of each of the following fuses: 5A, 7.5A, 10A, 15A, 20A, 25A, 30A</p> <p>Technical Data</p> <table border="1"> <tr> <td>Voltage Rating</td> <td>58 VCD or less</td> </tr> <tr> <td>Interrupting Rating:</td> <td>1000A @ 58 VCD</td> </tr> <tr> <td>Operating Temperature Range:</td> <td>-40° C a + 125° C</td> </tr> <tr> <td>Complies:</td> <td>SAE J2077 / JASO D612 / ISO 8820-3 / ROHS</td> </tr> </table>	Voltage Rating	58 VCD or less	Interrupting Rating:	1000A @ 58 VCD	Operating Temperature Range:	-40° C a + 125° C	Complies:	SAE J2077 / JASO D612 / ISO 8820-3 / ROHS	<table border="1"> <tr> <td>358129961</td> <td>MINI Fuse assortment</td> <td>Quantity: 140 pieces</td> </tr> </table>	358129961	MINI Fuse assortment	Quantity: 140 pieces
Voltage Rating	58 VCD or less												
Interrupting Rating:	1000A @ 58 VCD												
Operating Temperature Range:	-40° C a + 125° C												
Complies:	SAE J2077 / JASO D612 / ISO 8820-3 / ROHS												
358129961	MINI Fuse assortment	Quantity: 140 pieces											
<p>STANDARD Fuse assortment</p> 	<p>Assortment of fast acting fuses. It contains: 10 pieces of each of the following fuses: 5A, 7.5A, 25A, 30A 20 pieces of each of the following fuses: 10A, 15A, 20A</p> <p>Technical Data</p> <table border="1"> <tr> <td>Voltage Rating</td> <td>58 VCD or less</td> </tr> <tr> <td>Interrupting Rating:</td> <td>1000A @ 58 VCD</td> </tr> <tr> <td>Operating Temperature Range:</td> <td>-40° C a + 125° C</td> </tr> <tr> <td>Complies:</td> <td>SAE J1284 / JASOD612 / ISO 8820-3 / ROHS</td> </tr> </table>	Voltage Rating	58 VCD or less	Interrupting Rating:	1000A @ 58 VCD	Operating Temperature Range:	-40° C a + 125° C	Complies:	SAE J1284 / JASOD612 / ISO 8820-3 / ROHS	<table border="1"> <tr> <td>358129991</td> <td>STANDARD fuse assortment</td> <td>Quantity: 100 pieces</td> </tr> </table>	358129991	STANDARD fuse assortment	Quantity: 100 pieces
Voltage Rating	58 VCD or less												
Interrupting Rating:	1000A @ 58 VCD												
Operating Temperature Range:	-40° C a + 125° C												
Complies:	SAE J1284 / JASOD612 / ISO 8820-3 / ROHS												
358129991	STANDARD fuse assortment	Quantity: 100 pieces											
<p>MAXI Fuse assortment</p> 	<p>Assortment of slow-blow fuses. It contains: 5 pieces of each of the following fuses: 70A, 80A 10 pieces of each of the following fuses: 20A, 30A, 40A, 50A, 60A</p> <p>Technical Data</p> <table border="1"> <tr> <td>Voltage Rating</td> <td>58 VCD or less</td> </tr> <tr> <td>Interrupting Rating:</td> <td>1000A @ 58 VCD</td> </tr> <tr> <td>Operating Temperature Range:</td> <td>-40° C a + 125° C</td> </tr> <tr> <td>Complies:</td> <td>SAE J1888 / JASO D612 / ISO 8820-3 / ROHS</td> </tr> </table>	Voltage Rating	58 VCD or less	Interrupting Rating:	1000A @ 58 VCD	Operating Temperature Range:	-40° C a + 125° C	Complies:	SAE J1888 / JASO D612 / ISO 8820-3 / ROHS	<table border="1"> <tr> <td>358129971</td> <td>MAXI fuse assortment</td> <td>Quantity: 60 pieces</td> </tr> </table>	358129971	MAXI fuse assortment	Quantity: 60 pieces
Voltage Rating	58 VCD or less												
Interrupting Rating:	1000A @ 58 VCD												
Operating Temperature Range:	-40° C a + 125° C												
Complies:	SAE J1888 / JASO D612 / ISO 8820-3 / ROHS												
358129971	MAXI fuse assortment	Quantity: 60 pieces											

Product image / Dimensions	Part Number	Description																																							
<p>MINI LP fuses (low profile)</p>  <p>Fast Acting</p>	<p>Voltage Rating: 58 VCD or less Interrupting Rating: 1000A @ 58 VCD Operating Temperature Range: -40° C a + 125° C Complies: JASO D612 / ISO 8820-9 / ROHS</p>	<table border="1"> <tr><td>358129003</td><td>MINI LP fuse, boxed, 2A: gray</td><td>Quantity: 200 pieces</td></tr> <tr><td>358129013</td><td>MINI LP fuse, boxed, 3A: violet</td><td>Quantity: 200 pieces</td></tr> <tr><td>358129023</td><td>MINI LP fuse, boxed, 4A: pink</td><td>Quantity: 200 pieces</td></tr> <tr><td>358129033</td><td>MINI LP fuse, boxed, 5A: beige</td><td>Quantity: 200 pieces</td></tr> <tr><td>358129043</td><td>MINI LP fuse, boxed, 7.5A: brown</td><td>Quantity: 200 pieces</td></tr> <tr><td>358129053</td><td>MINI LP fuse, boxed, 10A: red</td><td>Quantity: 200 pieces</td></tr> <tr><td>358129063</td><td>MINI LP fuse, boxed, 15A: blue</td><td>Quantity: 200 pieces</td></tr> <tr><td>358129073</td><td>MINI LP fuse, boxed, 20A: yellow</td><td>Quantity: 200 pieces</td></tr> <tr><td>358129083</td><td>MINI LP fuse, boxed, 25A: white</td><td>Quantity: 200 pieces</td></tr> <tr><td>358129093</td><td>MINI LP fuse, boxed, 30A: green</td><td>Quantity: 200 pieces</td></tr> </table>	358129003	MINI LP fuse, boxed, 2A: gray	Quantity: 200 pieces	358129013	MINI LP fuse, boxed, 3A: violet	Quantity: 200 pieces	358129023	MINI LP fuse, boxed, 4A: pink	Quantity: 200 pieces	358129033	MINI LP fuse, boxed, 5A: beige	Quantity: 200 pieces	358129043	MINI LP fuse, boxed, 7.5A: brown	Quantity: 200 pieces	358129053	MINI LP fuse, boxed, 10A: red	Quantity: 200 pieces	358129063	MINI LP fuse, boxed, 15A: blue	Quantity: 200 pieces	358129073	MINI LP fuse, boxed, 20A: yellow	Quantity: 200 pieces	358129083	MINI LP fuse, boxed, 25A: white	Quantity: 200 pieces	358129093	MINI LP fuse, boxed, 30A: green	Quantity: 200 pieces									
358129003	MINI LP fuse, boxed, 2A: gray	Quantity: 200 pieces																																							
358129013	MINI LP fuse, boxed, 3A: violet	Quantity: 200 pieces																																							
358129023	MINI LP fuse, boxed, 4A: pink	Quantity: 200 pieces																																							
358129033	MINI LP fuse, boxed, 5A: beige	Quantity: 200 pieces																																							
358129043	MINI LP fuse, boxed, 7.5A: brown	Quantity: 200 pieces																																							
358129053	MINI LP fuse, boxed, 10A: red	Quantity: 200 pieces																																							
358129063	MINI LP fuse, boxed, 15A: blue	Quantity: 200 pieces																																							
358129073	MINI LP fuse, boxed, 20A: yellow	Quantity: 200 pieces																																							
358129083	MINI LP fuse, boxed, 25A: white	Quantity: 200 pieces																																							
358129093	MINI LP fuse, boxed, 30A: green	Quantity: 200 pieces																																							
<p>MINI fuses</p>  <p>Fast Acting</p>	<p>Technical data: Voltage Rating: 58 VCD or less Interrupting Rating: 1000A @ 58 VCD Operating Temperature Range: -40° C a + 125° C Complies: SAE J2077 / JASO D612 / ISO 8820-3 / ROHS</p>	<table border="1"> <tr><td>358129103</td><td>MINI fuse, boxed, 2A: gray</td><td>Quantity: 200 pieces</td></tr> <tr><td>358129113</td><td>MINI fuse, boxed, 3A: violet</td><td>Quantity: 200 pieces</td></tr> <tr><td>358129123</td><td>MINI fuse, boxed, 4A: pink</td><td>Quantity: 200 pieces</td></tr> <tr><td>358129133</td><td>MINI fuse, boxed, 5A: beige</td><td>Quantity: 200 pieces</td></tr> <tr><td>358129143</td><td>MINI fuse, boxed, 7.5A: brown</td><td>Quantity: 200 pieces</td></tr> <tr><td>358129153</td><td>MINI fuse, boxed, 10A: red</td><td>Quantity: 200 pieces</td></tr> <tr><td>358129163</td><td>MINI fuse, boxed, 15A: blue</td><td>Quantity: 200 pieces</td></tr> <tr><td>358129173</td><td>MINI fuse, boxed, 20A: yellow</td><td>Quantity: 200 pieces</td></tr> <tr><td>358129183</td><td>MINI fuse, boxed, 25A: white</td><td>Quantity: 200 pieces</td></tr> <tr><td>358129193</td><td>MINI fuse, boxed, 30A: green</td><td>Quantity: 200 pieces</td></tr> <tr><td>358129203</td><td>MINI fuse, boxed, 35A: dark green</td><td>Quantity: 200 pieces</td></tr> </table>	358129103	MINI fuse, boxed, 2A: gray	Quantity: 200 pieces	358129113	MINI fuse, boxed, 3A: violet	Quantity: 200 pieces	358129123	MINI fuse, boxed, 4A: pink	Quantity: 200 pieces	358129133	MINI fuse, boxed, 5A: beige	Quantity: 200 pieces	358129143	MINI fuse, boxed, 7.5A: brown	Quantity: 200 pieces	358129153	MINI fuse, boxed, 10A: red	Quantity: 200 pieces	358129163	MINI fuse, boxed, 15A: blue	Quantity: 200 pieces	358129173	MINI fuse, boxed, 20A: yellow	Quantity: 200 pieces	358129183	MINI fuse, boxed, 25A: white	Quantity: 200 pieces	358129193	MINI fuse, boxed, 30A: green	Quantity: 200 pieces	358129203	MINI fuse, boxed, 35A: dark green	Quantity: 200 pieces						
358129103	MINI fuse, boxed, 2A: gray	Quantity: 200 pieces																																							
358129113	MINI fuse, boxed, 3A: violet	Quantity: 200 pieces																																							
358129123	MINI fuse, boxed, 4A: pink	Quantity: 200 pieces																																							
358129133	MINI fuse, boxed, 5A: beige	Quantity: 200 pieces																																							
358129143	MINI fuse, boxed, 7.5A: brown	Quantity: 200 pieces																																							
358129153	MINI fuse, boxed, 10A: red	Quantity: 200 pieces																																							
358129163	MINI fuse, boxed, 15A: blue	Quantity: 200 pieces																																							
358129173	MINI fuse, boxed, 20A: yellow	Quantity: 200 pieces																																							
358129183	MINI fuse, boxed, 25A: white	Quantity: 200 pieces																																							
358129193	MINI fuse, boxed, 30A: green	Quantity: 200 pieces																																							
358129203	MINI fuse, boxed, 35A: dark green	Quantity: 200 pieces																																							
<p>STANDARD fuses</p>  <p>Fast Acting</p>	<p>Technical data: Voltage Rating: 58 VCD or less Interrupting Rating: 1000A @ 58 VCD Operating Temperature Range: -40° C a + 125° C Complies: SAE J1284 / JASOD612 / ISO 8820-3 / ROHS</p>	<table border="1"> <tr><td>358129213</td><td>STANDARD fuse, boxed, 1A: black</td><td>Quantity: 100 pieces</td></tr> <tr><td>358129223</td><td>STANDARD fuse, boxed, 2A: gray</td><td>Quantity: 100 pieces</td></tr> <tr><td>358129233</td><td>STANDARD fuse, boxed, 3A: violet</td><td>Quantity: 100 pieces</td></tr> <tr><td>358129243</td><td>STANDARD fuse, boxed, 4A: pink</td><td>Quantity: 100 pieces</td></tr> <tr><td>358129253</td><td>STANDARD fuse, boxed, 5A: beige</td><td>Quantity: 100 pieces</td></tr> <tr><td>358129263</td><td>STANDARD fuse, boxed, 7.5A: brown</td><td>Quantity: 100 pieces</td></tr> <tr><td>358129273</td><td>STANDARD fuse, boxed, 10A: red</td><td>Quantity: 100 pieces</td></tr> <tr><td>358129283</td><td>STANDARD fuse, boxed, 15A: blue</td><td>Quantity: 100 pieces</td></tr> <tr><td>358129293</td><td>STANDARD fuse, boxed, 20A: yellow</td><td>Quantity: 100 pieces</td></tr> <tr><td>358129303</td><td>STANDARD fuse, boxed, 25A: white</td><td>Quantity: 100 pieces</td></tr> <tr><td>358129313</td><td>STANDARD fuse, boxed, 30A: green</td><td>Quantity: 100 pieces</td></tr> <tr><td>358129323</td><td>STANDARD fuse, boxed, 35A: dark green</td><td>Quantity: 100 pieces</td></tr> <tr><td>358129333</td><td>STANDARD fuse, boxed, 40A: orange</td><td>Quantity: 100 pieces</td></tr> </table>	358129213	STANDARD fuse, boxed, 1A: black	Quantity: 100 pieces	358129223	STANDARD fuse, boxed, 2A: gray	Quantity: 100 pieces	358129233	STANDARD fuse, boxed, 3A: violet	Quantity: 100 pieces	358129243	STANDARD fuse, boxed, 4A: pink	Quantity: 100 pieces	358129253	STANDARD fuse, boxed, 5A: beige	Quantity: 100 pieces	358129263	STANDARD fuse, boxed, 7.5A: brown	Quantity: 100 pieces	358129273	STANDARD fuse, boxed, 10A: red	Quantity: 100 pieces	358129283	STANDARD fuse, boxed, 15A: blue	Quantity: 100 pieces	358129293	STANDARD fuse, boxed, 20A: yellow	Quantity: 100 pieces	358129303	STANDARD fuse, boxed, 25A: white	Quantity: 100 pieces	358129313	STANDARD fuse, boxed, 30A: green	Quantity: 100 pieces	358129323	STANDARD fuse, boxed, 35A: dark green	Quantity: 100 pieces	358129333	STANDARD fuse, boxed, 40A: orange	Quantity: 100 pieces
358129213	STANDARD fuse, boxed, 1A: black	Quantity: 100 pieces																																							
358129223	STANDARD fuse, boxed, 2A: gray	Quantity: 100 pieces																																							
358129233	STANDARD fuse, boxed, 3A: violet	Quantity: 100 pieces																																							
358129243	STANDARD fuse, boxed, 4A: pink	Quantity: 100 pieces																																							
358129253	STANDARD fuse, boxed, 5A: beige	Quantity: 100 pieces																																							
358129263	STANDARD fuse, boxed, 7.5A: brown	Quantity: 100 pieces																																							
358129273	STANDARD fuse, boxed, 10A: red	Quantity: 100 pieces																																							
358129283	STANDARD fuse, boxed, 15A: blue	Quantity: 100 pieces																																							
358129293	STANDARD fuse, boxed, 20A: yellow	Quantity: 100 pieces																																							
358129303	STANDARD fuse, boxed, 25A: white	Quantity: 100 pieces																																							
358129313	STANDARD fuse, boxed, 30A: green	Quantity: 100 pieces																																							
358129323	STANDARD fuse, boxed, 35A: dark green	Quantity: 100 pieces																																							
358129333	STANDARD fuse, boxed, 40A: orange	Quantity: 100 pieces																																							
<p>MAXI fuses</p>  <p>Slow-blow</p>	<p>Technical data: Voltage Rating: 58 VCD or less Interrupting Rating: 1000A @ 58 VCD Operating Temperature Range: -40° C a + 125° C Complies: SAE J1888 / JASO D612 / ISO 8820-3 / ROHS</p>	<table border="1"> <tr><td>358129343</td><td>MAXI fuse, boxed, 20A: yellow</td><td>Quantity: 20 pieces</td></tr> <tr><td>358129353</td><td>MAXI fuse, boxed, 30A: green</td><td>Quantity: 20 pieces</td></tr> <tr><td>358129363</td><td>MAXI fuse, boxed, 40A: orange</td><td>Quantity: 20 pieces</td></tr> <tr><td>358129373</td><td>MAXI fuse, boxed, 50A: red</td><td>Quantity: 20 pieces</td></tr> <tr><td>358129383</td><td>MAXI fuse, boxed, 60A: blue</td><td>Quantity: 20 pieces</td></tr> <tr><td>358129393</td><td>MAXI fuse, boxed, 70A: brown</td><td>Quantity: 20 pieces</td></tr> <tr><td>358129403</td><td>MAXI fuse, boxed, 80A: white</td><td>Quantity: 20 pieces</td></tr> </table>	358129343	MAXI fuse, boxed, 20A: yellow	Quantity: 20 pieces	358129353	MAXI fuse, boxed, 30A: green	Quantity: 20 pieces	358129363	MAXI fuse, boxed, 40A: orange	Quantity: 20 pieces	358129373	MAXI fuse, boxed, 50A: red	Quantity: 20 pieces	358129383	MAXI fuse, boxed, 60A: blue	Quantity: 20 pieces	358129393	MAXI fuse, boxed, 70A: brown	Quantity: 20 pieces	358129403	MAXI fuse, boxed, 80A: white	Quantity: 20 pieces																		
358129343	MAXI fuse, boxed, 20A: yellow	Quantity: 20 pieces																																							
358129353	MAXI fuse, boxed, 30A: green	Quantity: 20 pieces																																							
358129363	MAXI fuse, boxed, 40A: orange	Quantity: 20 pieces																																							
358129373	MAXI fuse, boxed, 50A: red	Quantity: 20 pieces																																							
358129383	MAXI fuse, boxed, 60A: blue	Quantity: 20 pieces																																							
358129393	MAXI fuse, boxed, 70A: brown	Quantity: 20 pieces																																							
358129403	MAXI fuse, boxed, 80A: white	Quantity: 20 pieces																																							

Product image / Dimensions	Part Number	Description
MINI LP FUSES Low profile 	358129002	MINI LP fuse, boxed, 2A: gray Quantity: 10 pieces
	358129012	MINI LP fuse, boxed, 3A: violet Quantity: 10 pieces
	358129022	MINI LP fuse, boxed, 4A: pink Quantity: 10 pieces
	358129032	MINI LP fuse, boxed, 5A: beige Quantity: 10 pieces
	358129042	MINI LP fuse, boxed, 7.5A: brown Quantity: 10 pieces
	358129052	MINI LP fuse, boxed, 10A: red Quantity: 10 pieces
	358129062	MINI LP fuse, boxed, 15A: blue Quantity: 10 pieces
	358129072	MINI LP fuse, boxed, 20A: yellow Quantity: 10 pieces
	358129082	MINI LP fuse, boxed, 25A: white Quantity: 10 pieces
	358129092	MINI LP fuse, boxed, 30A: green Quantity: 10 pieces
358129941	Assortment of fuses, includes: 1 piece of each fuse: 5A, 7.5A, 25A, 30A 2 pieces of each fuse: 10A, 15A, 20A Quantity: 10 pieces	
MINI FUSES 	358129102	MINI fuse, boxed, 2A: gray Quantity: 10 pieces
	358129112	MINI fuse, boxed, 3A: violet Quantity: 10 pieces
	358129122	MINI fuse, boxed, 4A: pink Quantity: 10 pieces
	358129132	MINI fuse, boxed, 5A: beige Quantity: 10 pieces
	358129142	MINI fuse, boxed, 7.5A: brown Quantity: 10 pieces
	358129152	MINI fuse, boxed, 10A: red Quantity: 10 pieces
	358129162	MINI fuse, boxed, 15A: blue Quantity: 10 pieces
	358129172	MINI fuse, boxed, 20A: yellow Quantity: 10 pieces
	358129182	MINI fuse, boxed, 25A: white Quantity: 10 pieces
	358129192	MINI fuse, boxed, 30A: green Quantity: 10 pieces
358129202	MINI fuse, boxed, 35A: dark green Quantity: 10 pieces	
358129951	Assortment of fuses, includes: 1 piece of each fuse: 5A, 7.5A, 25A, 30A 2 pieces of each fuse: 10A, 15A, 20A Quantity: 10 pieces	
STANDARD FUSES 	358129212	STANDARD fuse, boxed, 1A: black Quantity: 10 pieces
	358129222	STANDARD fuse, boxed, 2A: gray Quantity: 10 pieces
	358129232	STANDARD fuse, boxed, 3A: violet Quantity: 10 pieces
	358129242	STANDARD fuse, boxed, 4A: pink Quantity: 10 pieces
	358129252	STANDARD fuse, boxed, 5A: beige Quantity: 10 pieces
	358129262	STANDARD fuse, boxed, 7.5A: brown Quantity: 10 pieces
	358129272	STANDARD fuse, boxed, 10A: red Quantity: 10 pieces
	358129282	STANDARD fuse, boxed, 15A: blue Quantity: 10 pieces
	358129292	STANDARD fuse, boxed, 20A: yellow Quantity: 10 pieces
	358129302	STANDARD fuse, boxed, 25A: white Quantity: 10 pieces
358129312	STANDARD fuse, boxed, 30A: green Quantity: 10 pieces	
358129322	STANDARD fuse, boxed, 35A: dark green Quantity: 10 pieces	
358129332	STANDARD fuse, boxed, 40A: orange Quantity: 10 pieces	
358129981	Assortment of fuses, includes: 1 piece of each fuse: 5A, 7.5A, 25A, 30A 2 pieces of each fuse: 10A, 15A, 20A Quantity: 10 pieces	
MAXI FUSES 	358129341	MAXI fuse, boxed 20A: yellow Quantity: 1 piece
	358129351	MAXI fuse, boxed 30A: green Quantity: 1 piece
	358129361	MAXI fuse, boxed 40A: orange Quantity: 1 piece
	358129371	MAXI fuse, boxed 50A: red Quantity: 1 piece
	358129381	MAXI fuse, boxed 60A: blue Quantity: 1 piece
	358129391	MAXI fuse, boxed 70A: brown Quantity: 1 piece
	358129401	MAXI fuse, boxed 80A: white Quantity: 1 piece

Product image / Dimensions	Part Number	Description
Pole Plug - Metal 	001918002	With strain relief and grommet. 7-pin plug with screw connections Quantity: 25 pieces
Pole Plug - Plastic 	001930003	With strain relief and grommet. 7-pin plug with screw connections Quantity: 25 pieces
Pole Socket - Metal 	001941002	Metal socket with lid Removable contact set. Thermal stability: -25 °C a +70 °C. 7-pole plug socket with screw connections Quantity: 25 pieces
Pole Socket - Plastic 	001943003	Plastic socket with lid Removable contact set. Thermal stability: -25 °C a +70 °C. 7-pole plug socket with screw connections Quantity: 25 pieces

**7-pole plug system / 12 V (compliant with ISO 1724)
Pin-out – trailer plug fitting 12 V / 7-pole N type ISO 1724**

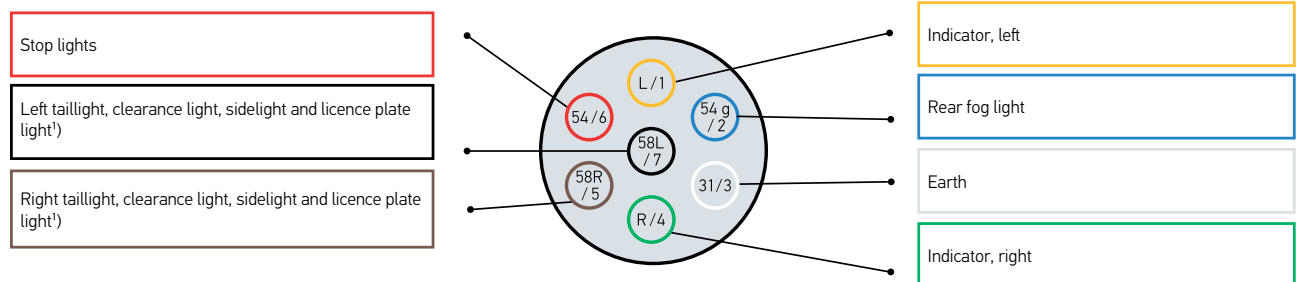

Contact assignment for normal plug-type connectors compliant with ISO 1724, 12 V, 7-pole N

Contact no.	Function	Cable cross-section	Colour of wire insulation
1/L	Indicator, left	1.5 mm ²	Yellow
2/54g	Rear fog light	1.5 mm ²	Blue
3/31	Earth	2.5 mm ²	White
4/R	Indicator, right	1.5 mm ²	Green
5/58R	Right taillight, clearance light, sidelight and licence plate lights ¹⁾	1.5 mm ²	Brown
6/54	Stop lights	1.5 mm ²	Red
7/58L	Left taillight, clearance light, sidelight and licence plate lights ¹⁾	1.5 mm ²	Black

¹⁾ The licence plate lights must be connected in such a way that none of the lamps is connected to both contacts 5 and 7.

Product image / Dimensions	Part Number	Description
	<p>Helical cable, 12V</p> <p>Helical cable, 7 poles, 12V, "N" Normal version for functions of the Highway Code and German registration (ISO 1724 and 6722).</p> <p>Resistant to cold, heat and weather, high resistance to oils and chemicals, excellent alternating flex properties, magnificent behavior of reset to the initial state. Coating: polyurethane. Cable section: 6 x 1.0 + 1 x 1.5 mm². Cable Ø 8.8 mm. External spiral: Ø 48 mm. max. working length: 4.0m.</p>	<p>004797021 Helical cable with 2 metal plugs</p>
	<p>Helical cable, 24V</p> <p>Helical cable, 7 poles, 24V, "N" Normal version for functions of the Highway Code and German registration + "S" for special functions (ISO 1185, 3731 and 6722).</p> <p>Resistant to cold, heat and weather, high resistance to oils and chemical products, excellent alternating flex properties, excellent recovery behavior to the initial state. Coating: polyurethane. Cable section: 6 x 1.0 + 1 x 1.5 mm². max. working length: 4.0m.</p>	<p>004797071 Helical cable Type "N" conforming to ISO 1185 and 6722, with 2 metal plugs</p>
	<p>Socket outlet with metal cover (ISO 1185) - Type "N"</p> <p>With rubber gasket on the closing cap. Protection tube for Ø 8 - 11 mm and 16.5 - 19.5 mm cables.</p>	<p>003833001 7-pole socket outlet with 7 screw connections - Quantity: 10 pieces</p>
	<p>Metal Plug (ISO 1185) - Type "N"</p> <p>With PG thread and internal gasket for Ø 9.2-11.5 mm cables.</p>	<p>003831001 7-pole plug with 7 screw connections - Quantity: 10 pieces</p>

Product image / Dimensions	Part Number	Description																				
<p>Battery main switch</p>	<table border="1"> <tr> <td>Part Number</td> <td>001559001</td> </tr> <tr> <td>Description</td> <td>Battery main switch</td> </tr> <tr> <td>Rated current</td> <td>100 A</td> </tr> <tr> <td>Capacity at 24 V.</td> <td>max 2500 A/10 seconds</td> </tr> <tr> <td>Connection</td> <td>M10</td> </tr> <tr> <td>Mounting type</td> <td>Screw</td> </tr> <tr> <td>DIN / ISO standard</td> <td>40050</td> </tr> <tr> <td>Number of connectors</td> <td>2 (with one screw for each terminal, includes 1 nut per screw)</td> </tr> <tr> <td>Control Type</td> <td>Knob twist control</td> </tr> <tr> <td>Combination switch function</td> <td>Closing</td> </tr> </table>	Part Number	001559001	Description	Battery main switch	Rated current	100 A	Capacity at 24 V.	max 2500 A/10 seconds	Connection	M10	Mounting type	Screw	DIN / ISO standard	40050	Number of connectors	2 (with one screw for each terminal, includes 1 nut per screw)	Control Type	Knob twist control	Combination switch function	Closing	
Part Number	001559001																					
Description	Battery main switch																					
Rated current	100 A																					
Capacity at 24 V.	max 2500 A/10 seconds																					
Connection	M10																					
Mounting type	Screw																					
DIN / ISO standard	40050																					
Number of connectors	2 (with one screw for each terminal, includes 1 nut per screw)																					
Control Type	Knob twist control																					
Combination switch function	Closing																					
	<table border="1"> <tr> <td>Part Number</td> <td>002843002</td> </tr> <tr> <td>Description</td> <td>Battery main switch</td> </tr> <tr> <td>Rated current</td> <td>50 A</td> </tr> <tr> <td>Capacity at 24 V.</td> <td>max 1000 A/10 seconds</td> </tr> <tr> <td>Connection</td> <td>M10</td> </tr> <tr> <td>Mounting type</td> <td>Screw</td> </tr> <tr> <td>DIN / ISO standard</td> <td>40050-IPX4 front; IPX2 back</td> </tr> <tr> <td>Number of connectors</td> <td>2 (with one screw for each terminal, includes 1 nut per screw)</td> </tr> <tr> <td>Control Type</td> <td>Knob twist control</td> </tr> <tr> <td>Combination switch function</td> <td>Closing</td> </tr> </table>	Part Number	002843002	Description	Battery main switch	Rated current	50 A	Capacity at 24 V.	max 1000 A/10 seconds	Connection	M10	Mounting type	Screw	DIN / ISO standard	40050-IPX4 front; IPX2 back	Number of connectors	2 (with one screw for each terminal, includes 1 nut per screw)	Control Type	Knob twist control	Combination switch function	Closing	
Part Number	002843002																					
Description	Battery main switch																					
Rated current	50 A																					
Capacity at 24 V.	max 1000 A/10 seconds																					
Connection	M10																					
Mounting type	Screw																					
DIN / ISO standard	40050-IPX4 front; IPX2 back																					
Number of connectors	2 (with one screw for each terminal, includes 1 nut per screw)																					
Control Type	Knob twist control																					
Combination switch function	Closing																					
	<table border="1"> <tr> <td>Part Number</td> <td>002843017</td> </tr> <tr> <td>Description</td> <td>Battery main switch</td> </tr> <tr> <td>Rated current</td> <td>100 A</td> </tr> <tr> <td>Capacity at 24 V.</td> <td>max 1000 A/10 seconds</td> </tr> <tr> <td>Connection</td> <td>M10</td> </tr> <tr> <td>Mounting type</td> <td>Screw</td> </tr> <tr> <td>DIN / ISO standard</td> <td>40050-IPX4 front; IPX2 back</td> </tr> <tr> <td>Number of connectors</td> <td>2 (with one screw for each terminal, includes 1 nut per screw)</td> </tr> <tr> <td>Control Type</td> <td>Knob twist control</td> </tr> <tr> <td>Combination switch function</td> <td>Closing</td> </tr> </table>	Part Number	002843017	Description	Battery main switch	Rated current	100 A	Capacity at 24 V.	max 1000 A/10 seconds	Connection	M10	Mounting type	Screw	DIN / ISO standard	40050-IPX4 front; IPX2 back	Number of connectors	2 (with one screw for each terminal, includes 1 nut per screw)	Control Type	Knob twist control	Combination switch function	Closing	
Part Number	002843017																					
Description	Battery main switch																					
Rated current	100 A																					
Capacity at 24 V.	max 1000 A/10 seconds																					
Connection	M10																					
Mounting type	Screw																					
DIN / ISO standard	40050-IPX4 front; IPX2 back																					
Number of connectors	2 (with one screw for each terminal, includes 1 nut per screw)																					
Control Type	Knob twist control																					
Combination switch function	Closing																					

EXPERTISE IN ELECTRONICS FOR ORIGINAL EQUIPMENT

Wherever products have to be controlled, measured, regulated or monitored, HELLA components have been tested a million times, under extreme conditions. We work based on the needs of customers and produce the highest quality electronic components for agricultural vehicles, construction machinery, trucks, trailers, city buses, municipal vehicles and vehicles with special bodies, emergency vehicles, campers, motorcycles and cars sports.

We offer a wide range of electronic components in the three fields: in energy management, powertrain and other engine components, which must meet the most demanding operating demands in commercial and passenger vehicles.

HELLA electronic components for all vehicles, operate 24 hours under extremely difficult conditions, ensuring optimal and reliable performance.

The full range of HELLA Electronics



HELLA SENSORS: Up to 30% of the value of a new equipped car is due to its electrical system and, even more, to its electronic systems. That is not a matter of fashion, but the result of consumer demand to increase safety, convenience, information and entertainment while driving. However, any component installed in a car may one day fail. 52% of all failures are already caused by defective software or defective electronics.

HELLA sensors perform complex operations with components such as: speed sensors, flow meters, detonation sensors, manifold pressure / pressure sensors, coolant / oil / air temperature sensors, oxygen sensors (lambda), oil level sensors / coolant, throttle position and throttle valve position - among other components, ensuring optimal operation, at all times.



UPDATED!

HELLA ELECTRONICS VEHICLE SPECIFIC APPLICATIONS

For Hella Electronic vehicle specific applications products, consult our website for detailed information:

<https://hella.mypartfinder.com/>

Indispensable tool for today's online web search.



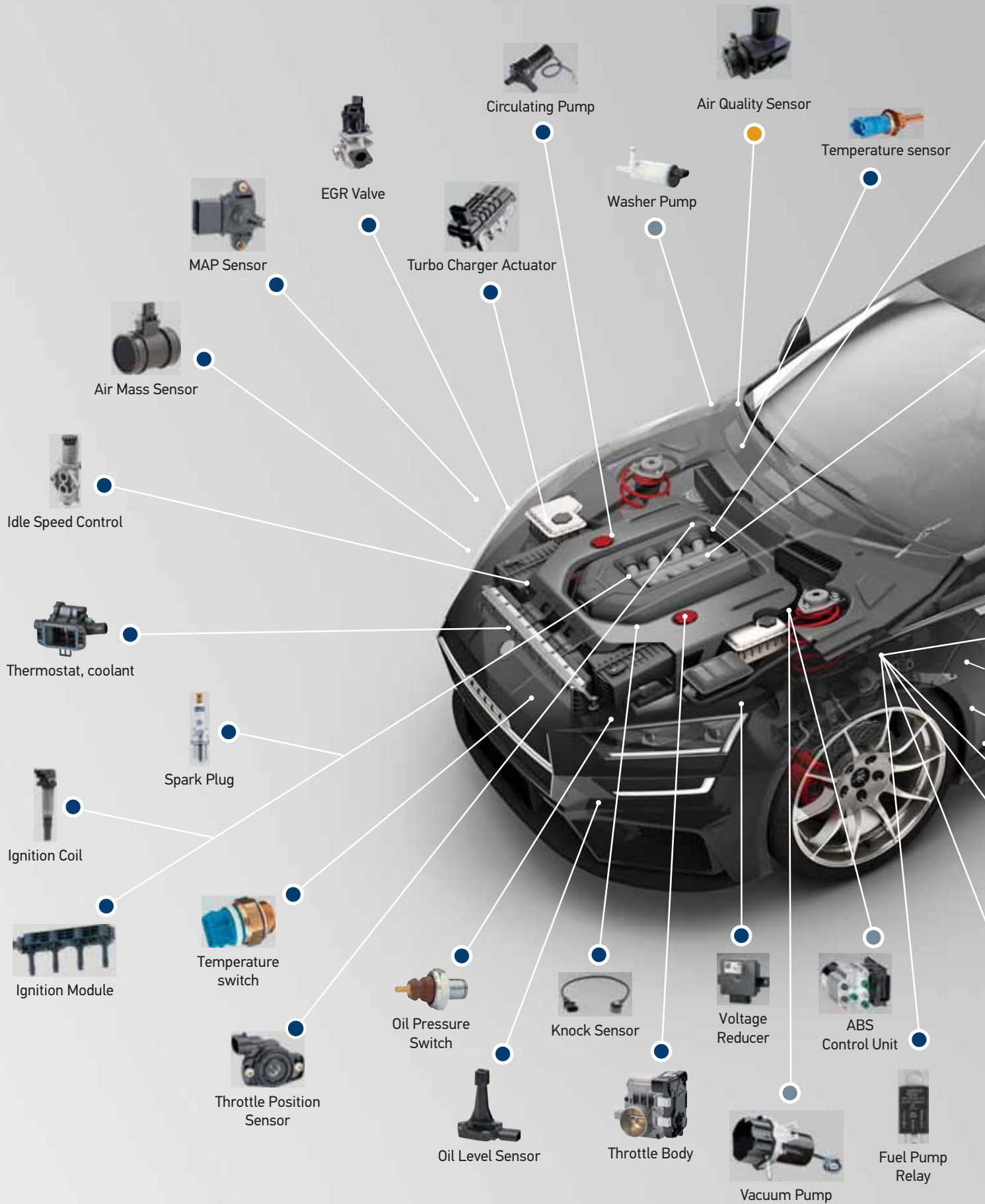



EMISSIONS

Extremely reliable due to its
robust design



PEDAL SENSORS

The pedal sensors transmit the driver's intention to the engine management system. With the principle of wear-free measurement of HELLA CIPOS® sensors and their low mechanical wear, they are ideal for driver's cabins in agricultural vehicles and construction machinery. They are available as suspended or floor mounted versions.

- Accurate position measurement with HELLA technology CIPOS® ($\pm 2\%$ accuracy) or a potentiometer
- Extensive application experience thanks to the production experience acquired since 1996
- Mechanical design variations according to the customer specifications

VACUUM PUMPS

Until recently, most brake superchargers used the vacuum generated by the air intake section of the internal combustion engine. However, with the introduction of new engine technologies (for example, hybrid vehicles, size reduction) or under specific operating conditions (for example, during the cold start / warm-up phase, driving at extreme altitudes or when using the system of air conditioning), the vacuum produced by the engine is no longer enough. Electric vacuum pumps are used to ensure reliable operation of the brake booster

HELLA's electronic product range includes four different types of vacuum pumps for each application. Our portfolio ranges from compact pumps to high performance pumps, depending on the required evacuation power

EMISSIONS

LEVEL SENSORS

The sensor architecture of the PULS (Packed Ultrasonic Level Sensor) oil level sensor consists of one single multi-chip module that integrates the ultrasonic sensor, the temperature sensor and an ASIC (Application Specific Integrated Circuit). The compactness of our sensors increases their impact and vibration resistance compared with sensors that are fitted with numerous electronic components. The ultrasonic sensor integrated in the multi-chip module transmits a signal that is reflected by the bounding surface between the motor oil and the air.

The signal's running time is measured and the filling level is calculated depending on the speed of sound in the medium. The attenuation cup attached above the multi-chip module serves to calm the medium (particularly) in the dynamic measuring range. The damping cap has openings at the base and at the tip, which allow permanent oil flow

Drive Train



INTELLIGENT BATTERY SENSORS

The intelligent battery sensor (IBS) from HELLA is the key element of vehicle energy management. The IBS reliably and accurately measures the battery parameters: voltage, current and temperature. Information about the battery's state of charge (SOC), state of battery health (SOH) and state of function (SOF) is calculated algorithmically from the measurements. The IBS is designed for use in starter, gel and AGM batteries to monitor in-vehicle starter or consumer batteries. The IBS can be directly integrated into the vehicle's electrical system with the standardised LIN protocol.

- Accurate measurement of voltage, current and temperature battery parameters
- Determining the battery condition parameters State of Charge (SOC), State of Battery Health (SOH) and State of Function (SOF)
- Simple electrical and mechanical integration

Energy Management



ABS CONTROL UNIT

- Analysis of the speed of all four wheels
- Electronic regulation of the braking force on each individual wheel → maximum possible brakeforce
- Self-diagnostic capability of the device: When the ignition is turned on, the system performs a self-test

Components



RADAR - HELLA OE PRODUCT

- First 24 GHz radar for rear end applications on the market
- Up to five functions possible:
 - Blind spot monitoring, lane change assistant, rear pre-crash system, rear cross traffic alert and vehicle exit assistant
- HELLA - the first supplier of radar sensor systems on the independent aftermarket

Components

SAFETY



LED LIGHT CONTROL UNIT

HELLA offers two different types of LED light control units designed to monitor lighting functions.

- Basic version: This only monitors the direction indicator
- Premium Version: This monitors all lighting functions

Only one control unit is required for the left and the right side.

- The DEUTSCH connector, itself integrated in the housing, enables easy integration in the vehicle architecture
- Active thermal management, including overheating protection, for a long service life
- Completely watertight and dust-proof for maximum functioning safety
- Electromagnetic compatibility (EMC) for trouble-free use of, for example, radio

Lighting electronics

COMFORT



RAIN/LIGHT SENSORS

The full range of functions of the rain-light sensor (five functions: rain sensor, light sensor, solar sensor, humidity measurement, and head-up display) can only be used for passenger vehicle applications. This sensor can only be used to a limited extent in vehicles with special windshields (thick, slanted, transmission).

The optics of the second sensor are specially designed for vehicles with steep windshields and combines the rain and light recognition functions (environment and tunnel recognition).

- Fourth generation of the long-established rain sensors by HELLA
- Five functions in one product: rain, light solar and humidity measurement and adjustment of the light intensity of the head-up display
- Optimised design – extremely compact package space

Components

FUEL PUMPS AND FUEL FEED UNITS

- High Quality Standards
- Large number of applications
- Designed for easy mounting
- Each unit is delivered with gaskets, according to the Original Equipment requirements* (as applicable)

OTHER FEATURES AND FUNCTIONS:

- The Fuel Pump is an integral part of the Fuel Delivery System
- Delivers fuel from the tank to the engine
- They are usually electrically powered.
- More power with less current draw than previous generation pumps

WHY HELLA FUEL PUMPS?

- Original Equipment Quality
- Tight seal on coupling caps
- Double sieve with finer mesh filter
- Better quality internal parts.
- Armor with Plastic-Metal and robust.
- Large and good weight magnets.
- Reinforced and nickel-plated casing.
- Hermetic seal on coupling covers.
- Relief and Check Valve.
- Country of origin: China.







PAGID

BRAKE SYSTEMS



BRAKEGUIDE
EASILY FIND SUITABLE PRODUCTS



www.partcat.com/hella

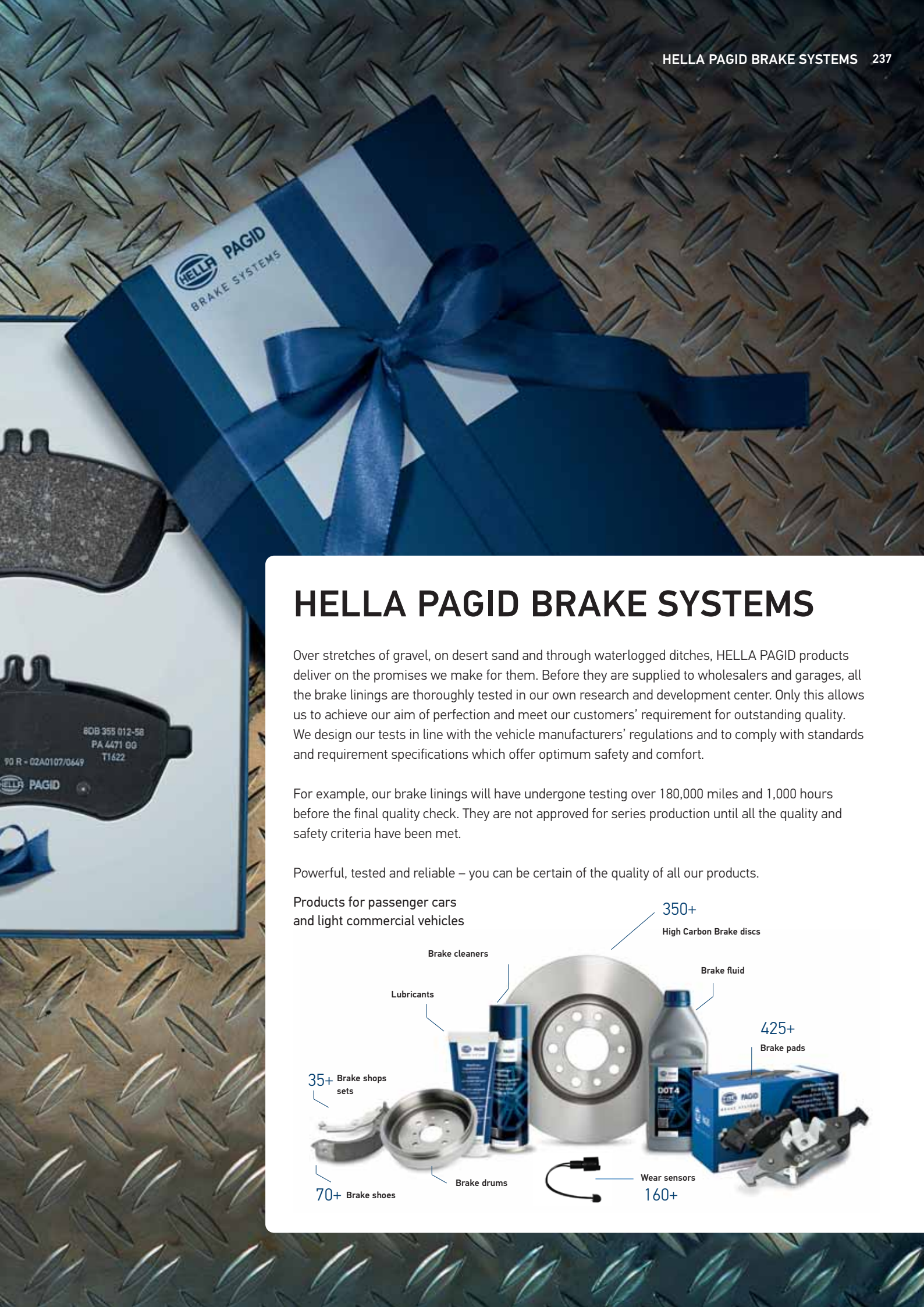

HELLA PAGID BRAKE SYSTEMS

Over stretches of gravel, on desert sand and through waterlogged ditches, HELLA PAGID products deliver on the promises we make for them. Before they are supplied to wholesalers and garages, all the brake linings are thoroughly tested in our own research and development center. Only this allows us to achieve our aim of perfection and meet our customers' requirement for outstanding quality. We design our tests in line with the vehicle manufacturers' regulations and to comply with standards and requirement specifications which offer optimum safety and comfort.

For example, our brake linings will have undergone testing over 180,000 miles and 1,000 hours before the final quality check. They are not approved for series production until all the quality and safety criteria have been met.

Powerful, tested and reliable – you can be certain of the quality of all our products.

Products for passenger cars and light commercial vehicles



BRAKE PADS



Hella Pagid is a leading supplier of innovative brake systems in the independent aftermarket. While supporting ASE we also have ASE brake specialists on staff. We can look back on decades of experience as an OEM and offer the sales competence of one of the largest trading organizations in the world. We combine proven OEM engineered brake technology with extensive professional sales support, leading innovation with first-class technical service and a complete product range with outstanding logistics. Hella Pagid brake pads are designed to match perfectly with Hella Pagid rotors and wear sensors to deliver maximum performance in terms of safety, comfort and service life.

- Over 100 compounds to assure you receive the right friction for your car
- Pad design and shims are identical to OEM
- OE stopping capability
- Better brake laws compliant
- Consistent brake feel in all operating conditions
- 98% European coverage
- ECR90 certification 100%

BRAKE ROTORS



These advanced, two-piece brake discs feature an aluminum hat and a High Carbon friction ring, which are bonded together by rivets. The use of aluminum delivers a weight savings of 15-20 percent and reduces the unsprung mass of the brake system. The resulting assembly not only improves driving properties, but also helps contribute to a reduction of fuel consumption.

Hella Pagid composite brake rotors are designed to match perfectly with Hella Pagid Brake System brake pads and wear sensors to deliver maximum performance in terms of safety, comfort and service life. Every Hella Pagid composite brake rotor is manufactured in accordance with strict OE tolerances

- Manufactured in Europe
- Improvement in driving properties
- High Carbon friction ring
- Reduction of fuel consumption
- Full range of BMW applications
- Less prone to warpage
- Quieter operation
- Easy installation
- Keeps rotors looking great for miles
- No cleaning required
- OE design



WEAR SENSORS BRAKE CALIPERS



LIGHT VEHICLES AND COMMERCIAL RANGE



Hella Pagid's new wear sensor range is produced 100% in Europe. Each wear sensor is meticulously produced with injection molding processes to withstand the most harsh conditions.

HellaPagid wear sensors are designed to match perfectly with Hella Pagid brake pads to deliver maximum performance in terms of safety, comfort and service life.

- Injection Molded for durability and quality
- Excellent thermal insulation
- Highly resistant to heat
- 100% made in Europe
- OE manufacturer
- 130+ wear sensors
- 90% European coverage

Hella Pagid Brake calipers: When it comes to brake calipers, we live up to these expectations by currently offering a line of over 112 core-free new parts and 1,400 remanufactured brake calipers with one, two and four-piston arrangements. All components receive anti-corrosion protection and, if required, are supplied with the required accessories (plug and play).

- All products undergo a 100% final inspection after production is complete
- Core-free new parts: Easy handling thanks to dispensing with core deposit processing, No capital tied up with core deposits, more warehouse capacities.
- Premium accessory kit for core-free brake calipers

The Hella Pagid Light Commercial range has been designed to leverage OE Brake competence with unique market experience to provide the best possible brake combination for your customers light commercial vehicles. Starting with increased stopping power from European produced pads and finishing off with High Carbon rotors to dissipate heat to allow optimum braking and increased longevity.

- European stopping power for light commercial applications due to high weight and an LCV's top-speed of ~105-110 miles on the German "Autobahn"
- High Carbon Rotors Designed to absorb and dissipate heat more effectively than iron rotors
- European Wear Sensor Program
- Heavy Duty Police and Taxi Pads
- OE quality



DIGITAL SERVICES

This section is devoted to helping visitors navigate to the correct sites according to the individual needs of original equipment, distributors, dealers and professional workshops.

PORTALS	
Web site + PDF's	www.hellausa.com
MICROSITES	
Auxiliary Lights, signal lighting, bulbs, horns, wiper blades, light bars and accessories	www.myhellalights.com
Work lights, relays, warning lights, etc.	www.hellahd.com
90 mm Headlights configurator	www.hella.com/90mm-modules
Agriculture	www.hella.com/agro
Buses	www.hella.com/bus
Shapeline configurator	www.hella.com/shapeline
ONLINE CATALOGS	
Universal parts catalog	www.hella.com/upc
Vehicles specific parts	https://hella.mypartfinder.com/ UPDATED!
Brake Systems	www.brakeguide.com
TECHNICAL INFORMATION	
HELLA TECH WORLD	www.hella.com/techworld

APPS FOR SMARTPHONES AND TABLETS

www.hella.com/apps



Horns



Auxiliary Lighting



Work lights



BrakeGuide

SOCIAL MEDIA

Facebook	www.facebook.com/hella.usa
Facebook	www.facebook.com/hellamining
Facebook	www.facebook.com/hellamarine
YouTube	www.youtube.com/myhellalights
Instagram	www.instagram.com/hella.usa
LinkedIn	www.linkedin.com/company/hella

UPDATED!
APPLICATION DATA

Mapping of information

ACES 4.0

(Aftermarket Catalog Exchange Standard)

PIES

(Product Information Exchange Standard)

Digital Assets

(Images)

Name of Product Line	OPTI CAT	EPICORE	WHI	DCI	SDC
	Code	Code	Code	Code	Code - Under HELLA, Inc.
HELLA Light Bulbs	HELLA BULBS	HES	HLA	Only bulbs and wiper blades	HELLA
HELLA Lighting for Specific Vehicles	HELLA ALL NO BULBS	HES	HLA		HELLA
HELLA Fuel Pumps	HELLA ALL NO BULBS	HEV	HLA		HELLA
HELLA Windshield Wipers	HELLA ALL NO BULBS	HEM	HLA		HELLA
HELLA Electronics	HELLA ALL NO BULBS	HEP	HLA		HELLA
Pierburg	HELLA PIERBURG	PGP	PIG		Pierburg
Behr Thermo-tronik	HELLA BTT		BEH		GTT
Optilux	HELLA OPTILUX	OPL	HLA	Optilux Lighting	Optilux
Pagid		HEA	HPD		
Pagid Silver		HED	HPN		

GET FREE TECHNICAL TRAINING

HELLA TECH WORLD

Prepare your automobile garage for the future. At HELLA TECH WORLD you will find all our technical expert knowledge in the fields of lighting, electrical, electronic, thermal management, brake systems and vehicle diagnostics. And best of all this content is available 24/7 for you and your customers for FREE!

Register today and start to acquire the knowledge that will give you a real advantage and competitive edge for greater success!

Visit:

www.hella.com/techworld

**REGISTER TODAY
FOR FREE!**



Scan this QR code from your Smartphone or Tablet to enter.

Multiple tools available:



Know-how Tool



Technical Information



www.hella.com/techworld



www.hella.com/partnerworld/

HELLA TECH WORLD

- Online platform for workshops
- Vehicle-specific repair Information
- Technical information
- Technical videos
- Responsive design

HELLA PARTNER WORLD

- Online portal for wholesalers
- Monthly list of new products for download
- Compact information about all highlight products
- Marketing support

Here is a summary of the most important basic terms in lighting technology and the respective units of measure for the evaluation of the properties of bulbs and lights..

Luminous flux Φ

Unit: Lumen [lm]

Luminous flux F is the term used to describe the complete light output radiated from a light source

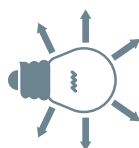

Luminous intensity I

Unit: Candela [cd]

Part of the luminous flux which radiates in a certain direction.



Illuminance E

Unit: Lux [lx]

Illuminance E specifies the ratio of the impinging luminous flux to the illuminated surface. Illuminance is 1 lx when a luminous flux of 1 lm impinges an area of 1 m².

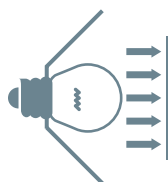

Luminance L

Unit: Candela per square metre [cd/m²]

Luminance L is the impression of brightness the eye has from a luminous or illuminated surface.



Light output η

Unit: Lumen per Watt [lm/W]

Light output η specifies the rate of efficiency with which the consumed electrical power is transformed into light.

Light sources

Light sources are radiators of temperatures which produce light through heat energy. This means the more strongly a light source is heated up, the higher its luminous intensity will be. The low efficiency (8 % light radiation) only allows a relatively low light output in comparison with gas discharge lamps (28 % light radiation). Recently, LEDs have started to be used as light source in front headlights

Colour temperature K

Unit: Kelvin [K]

Kelvin is the unit for colour temperature. The higher the temperature of a light source, the greater the blue share in the colour spectrum and the smaller the red share. A bulb with warm white light has a colour temperature of approx. 2,700 K. In contrast, a gas discharge lamp (D2S) with a colour temperature of 4,250 K produces cold white light which is, however, nearer to the colour of daylight (approx. 5,600 K).

Influence factors on a light source:

Despite the regeneration inside the lamp, the tungsten filament is gradually consumed, which limits its useful life. The durability and luminous efficiency depend strongly, between other factors, of the supply voltage present. The following empirical rule applies: if the supply voltage of a lamp is increased by 5%, the luminous flux increases by 20%, but at the same time the useful life is shortened by half.

Lumen lm:

It is the unit of the International Measurement System to measure the luminous flux, a measure of the light output emitted by the source. The luminous flux differs from the radiant flux in that the first it contemplates the variable sensitivity of the human eye to the different wavelengths of light and the latter involves all the electromagnetic radiation emitted by the light source according to the laws of Wien and Stefan-Boltzmann regardless of whether such radiation is visible or not.

$$1 \text{ lm} = 1 \text{ cd} \cdot \text{sr} + 1 \text{ lx} \cdot \text{m}^2$$

Candela cd:

It is the unit of the International System of Measures to measure light intensity. It is defined as: The light intensity is a given direction, from a source that emits a monochromatic radiation of 540 x 10¹² hertz frequency and of which the intensity radiated in that direction is 1/683 W watts per stereo radian.

Bulbs markings

Vehicle bulbs have to be standardised in compliance with ECE-R37 or R99. This makes bulb replacement possible while at the same time avoiding mix-ups with other bulbs. The following lettering can be found on bulbs:

- Name of the manufacturer
- 6 or 6 V, 12 or 12 V, 24 or 24 V stands for the nominal voltage in compliance with ECE regulation 37.
- H1, H4, H7, P21 W stands for the international category description of ECE-standardised bulbs e.g. 55 W.
- E1 indicates which country the light source has been tested and approved in. "1" stands for Germany.
- "DOT" means that it is also approved for use on the American market.
- "U" stands for UV-reduced bulbs, according to ECE. The bulbs are used in headlights with plastic cover lenses, for example..
- The approval mark granted by the appropriate authorities e.g. E1 (Federal Department of Motor Vehicles in Flensburg) is inscribed on the bulb and is either 37 R (E1) + a five-digit number or only (E1) + a three-digit number (sometimes alphanumeric codes, see illustration).
- Most bulbs have a coded manufacturer's mark. This makes traceability to the manufacturer possible.
- Since not all bulbs have enough room for the markings, the legislator prescribes only the following obligatory information: manufacturer, capacity, test mark and approval mark.

Tips for dealing with light sources

- Xenon headlights require high voltage for ignition, which is why the ballast voltage supply plug should always be removed before any work is carried out on the headlights.
- When replacing bulbs, never touch the new glass bulb since fingerprints will be burnt on and make the bulb opaque.
- If a xenon bulb breaks in a closed room (repair shop) the room should be ventilated to prevent a health hazard due to toxic gases. D3 and D4 xenon lamps do not contain mercury and are therefore more environmentally compatible.
- Standard filament and halogen bulbs do not contain any materials which are problematical from an environmental point of view and can be disposed of with normal household waste.
- In D3 and D4 xenon lamps, the mercury was replaced with non-toxic zinc iodide. These bulbs can be disposed of with normal household waste.

Type approval numbers on the headlight

National and international design and operating regulations apply for the manufacture and testing of vehicle lighting equipment. Special approval marks exist for headlights and can be found on the cover lens or on the housing.

One example

The following can be found on a cover lens HC/R 25 E1 02 A 44457:

- Code HC/R means: H for Halogen-, C for low beam and R for high beam.
- The slash between C and R means that low beam and high-beam cannot be switched on simultaneously (H4 main headlights).
- The subsequent reference number provides information about the luminous intensity of the spotlight.
- The code E1 means that the headlight has been approved in Germany.
- 02 A indicates that there is a clearance light (parking light)
- (A) in the headlight, the regulations for which have been revised twice (02) since publication.
- The five-digit number at the end is the type approval number which is assigned individually for every headlight design approval.

Help in deciphering the combinations of numbers and letters on headlights

ECE regulation 1

- A Clearance light
- B Fog light
- C Low beam
- R High beam
- CR High and low beam
- C/R High or low beam

ECE regulation 8, 20 (H4 only)

- HC Halogen low beam
- HC Halogen high and low beam
- HC/R Halogen high or low beam

ECE regulation 98

- DC Xenon low beam
 - DR Xenon high beam
 - DC/R Xenon high or low beam
- Simultaneous operation is prohibited.

ECE regulation 123

- X Advanced Frontlighting System

WHAT IP PROTECTION CATEGORIES ARE THERE?

Protection category IP 5K4K

Dust may only penetrate to such an extent that function and safety are not impaired. Water that is sprayed from every direction at increased pressure against the housing may not have any damaging effect: water pressure approx. 4 bar.

Protection category IP 5K9K

Dust may only penetrate to such an extent that function and safety are not impaired. Water that is directed from highpressure / steam-jet equipment onto the housing must not have any damaging effect: water pressure approx. 100 bar.

Protection category IP 6K4K

Dust must not penetrate. Water that is sprayed from every direction at increased pressure against the housing must not have any damaging effect: water pressure approx. 4 bar.

Protection class IP 67

Dust must not penetrate. No water may penetrate, even if the device is submersed for some time.

Degree of protection IP 6K9K

Dust must not penetrate. Water that is directed from highpressure / steam-jet equipment onto the housing must not have any damaging effect: water pressure approx. 100 bar

HELLA Automotive Sales, Inc.

201 Kelly Drive
Peachtree City, GA, 30269
Tel.: +1 (877) 224-3552
Fax: +1 (770) 631-7574
www.hellausa.com
www.myhellalights.com

HELLAMEX, S.A. de C.V.

Carretera México Querétaro Km 30,
Bodega 2B y Barranca Honda,
San Martín Obispo, Cuautitlán Izcalli,
Edo. de México. C.P. 54763
Tel. Ventas: +52 (55) 5321-1390
Servicio Técnico: 01 800 221-0471
hellamex@hella.com
www.hellamex.com

HELLA do Brasil Automotive Ltda.

Rua Bom Pastor, 2224 - 15º andar
São Paulo, SP
04203-002 Brasil
Telefone: +55 (11) 2627-7800
info.brasil@hella.com
www.hella-brasil.com

© HELLA GmbH & Co. KGaA, Lippstadt
999142492 10.2022
Printed in USA